



INTRODUCTION TO
OLI Flowsheet: ESP
V12.5



think simulation



getting the
chemistry right

Introduction to OLI Flowsheet: ESP

© 1997-2025 OLI Systems, Inc.

The enclosed materials are provided to the lessees, selected individuals, and agents of OLI Systems, Inc. The material may not be duplicated or otherwise provided to any entity without the expressed permission of OLI Systems, Inc.

Version: OLI Flowsheet: ESP V12.5

Contact Information

Visit the Contact OLI Systems page at <https://www.olisystems.com/techsupport> to submit general inquiries, contact Technical Support, or search for an address and phone number.

If you need to contact Support, you can submit an online request via OLI Support Center: <https://support.olisystems.com/>

Other useful links and resources are:

Product Downloads: <http://downloads.olisystems.com/>

OLI Systems YouTube Channel: <https://www.youtube.com/@OLISystems>

OLI Systems Support Center: <https://support.olisystems.com/>

Disclaimer

This manual was produced using the OLI Flowsheet: ESP 12.5.0 build 23. At the time this manual was produced, the product was still in beta, and some screen images may reflect that fact.

As time progresses, new data and refinements to existing data sets can result in values that you obtain being slightly different than what is presented in this manual. This is natural progress and cannot be avoided. When large systematic changes to the software occur, this manual will be updated.

Table of Contents

TABLE OF CONTENTS.....	3
CHAPTER I – GETTING STARTED WITH OLI FLOWSHEET: ESP	7
A Tour of OLI Flowsheet: ESP – The Basics	7
Creating the Process	7
Starting the tour	8
Defining the chemistry for this application	11
Building the process	14
Running the calculation	22
Obtaining preliminary results	24
Finishing the application	25
Running the final simulation design.....	31
A tour of OLI Flowsheet: ESP – Some Advanced Features	33
A tour of OLI Flowsheet: ESP – More Advanced Options	43
Modifying the chemistry	44
CHAPTER II – PROCESS OPTIONS	53
Overview	53
Menu Items.....	54
Toolbar	57
Adding callouts	59
Editing a callout	60
Editing the units for a callout	64
Copy and paste a callout	67
Process Options.....	69
Optional Properties	69
Recycles	70
Restart Options.....	72
Molecular Conversion Weights.....	74
Liq-2 Key Component.....	74
Calculation Aids.....	75
Block Calculation Order	75
CHAPTER III – REPORTS.....	76
Stream Report	77
Block Report.....	78
Multi-stream Report	78
Overall Process Balance Report	79

Water Analysis Report	80
CHAPTER IV – CHEMISTRY MODELS	81
Overview	81
Chemistry Tab	81
Inflows Tab	85
Phases Tab	90
Redox Tab	92
Kinetics Tab	95
T/P Span.....	98
CHAPTER V – PROCESS MODELING UNIT OPERATIONS/BLOCKS	100
Overview	100
Unit Operations/Blocks and Controllers	100
Unit Operations/Blocks and Controllers Summary Descriptions	101
Mixer	101
Separator	101
Neutralizer	101
Splitter.....	102
Component Splitter.....	102
Absorber	102
Stripper/Distillation Column	103
Extractor Unit.....	103
Reactor	104
Filter	104
Settler	104
RO Membrane (Reverse Osmosis)	105
Compressor	105
Turbine.....	105
Heat Exchanger	106
Incinerator.....	107
Pump	107
Feedback Controller	107
Feed-forward Controller.....	107
Manipulator	108
Virtual Stream Portal	108
Inlet Portal.....	108
Outlet Portal.....	109
Calculator.....	109
Sub-Flowsheet.....	109
Details of Unit Operations/Blocks	111
1. Mixer Unit.....	111
2. Separator Unit.....	112
3. Neutralizer Unit	114
Splitter Unit	115
Absorber Unit.....	117
Distillation/Stripper Unit	122
Extractor Unit.....	128
Reactor Unit.....	130

Filter Unit	135
Settler Unit.....	136
Compressor Unit.....	138
Turbine Unit.....	140
Heat Exchanger Unit	141
Incinerator.....	144
Feedback Controller	145
Feed-forward Controller Unit	148
Manipulator Unit	150
Direct Stream Manipulation	151
Pump	155
RO Membranes (Reverse Osmosis)	156
Virtual Stream Portal	162
Calculator.....	165
Sub-Flowsheet.....	167
CHAPTER VI – ANALYSES TAB.....	174
Sensitivity Analysis	174
HF Titration	174
Chemistry and Thermodynamic Framework	174
Flowsheet	175
Composition and setup.....	175
Create Analysis	177
Monitored Variables.....	179
Add Sensitivity Plot.....	181
Water Analysis (Ionic Input).....	183
Reconciliation Options.....	185
Optimizer Analysis.....	187
Describing the Sample Case.....	187
Adding the Optimizer Analysis	189
CHAPTER VII – CASE LIBRARY.....	210
Category.....	211
CHAPTER VIII – PROCESS APPLICATIONS	216
Reactor Block Examples	216
Standard Reaction Kinetics	216
Non-Standard (User Defined) Reaction Kinetics.....	223
Stoichiometric Reactors (CONV).....	229
Gibbs Reactor.....	233
RO Membranes (Reverse Osmosis) Example	238
Overview of RO	238
Defining the Chemistry Model	238
Defining the Flowsheet.....	239
Entering the stream and block parameters (except the RO membrane).	239
Defining the RO Membrane Block.....	243
Running the simulation	247

Calculator Functionality Example	249
Calculator Block.....	249
 APPENDIX-1 REVERSE OSMOSIS TECHNOLOGY.....	 250
OLI MEMBRANE TECHNOLOGY: SIMULATOR FOR REVERSE OSMOSIS PROCESS	250
Summary	250
Model Development.....	251
Permeability Estimate.....	252
References	253
 Definitions.....	 254
 Manufacturer Data Sheet for RO Membranes	 256
 APPENDIX-2 OPTIMIZER AND CALCULATOR BLOCK MATHEMATICAL FUNCTIONS	 258

Chapter I – Getting Started with OLI Flowsheet: ESP

A Tour of OLI Flowsheet: ESP – The Basics

With version 12, the default thermodynamic framework is the Mixed-solvent Electrolyte (MSE) framework. However, for some of the examples in this guide, we will use the legacy Aqueous (AQ) thermodynamic framework. When we are using a thermodynamic framework other than AQ, we will so indicate it.

This tour of OLI Flowsheet: ESP is based on a sample application - a pH neutralization problem. Suppose we have two waste streams that must be mixed. One of the streams is an acid stream (in that the pH is less than 7.0 at room temperature), and the other stream is a base stream. We know from general chemistry that when acid and base streams mix, generally heat is evolved, resulting in gases being produced. In addition, if the pH changes significantly, solids may form.

We want to treat any resulting gases from this mixing separately (we may need to recover the gases for another process), and we also want to remove any solids that may form. Finally, we want to make sure that the pH of the resulting liquid has been made basic.

Creating the Process

A diagram that represents this process in OLI Flowsheet: ESP, is shown below.

MIX1 is a mixer that adiabatically mixes the acid stream and the base stream at a set pressure. The resultant stream has a pH, temperature, and composition different from those of the inlet streams.

The next block chosen is a separator called SEPARATE1. This unit allows us to physically separate the multiphase product stream from MIX1 into separate vapor, liquid, and solids streams.

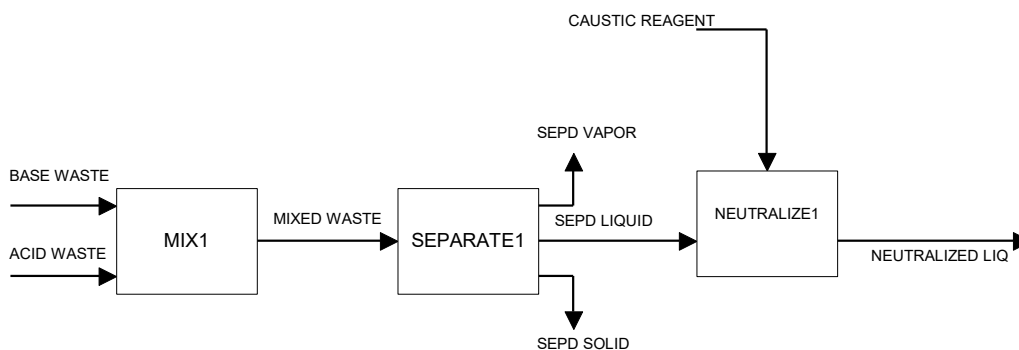

	Base Waste	Acid Waste	Caustic Reagent
Temperature (C)	40	25	30
Pressure (Atm)	1	1	1
Total Flow (mole/hr)	200	150	100
H2O	55.51	55.51	55.51
NH3	1.0	0	0
CO2	0.1	0	0
SO2	0.1	0	0
HCL	0	0.1	0
H2SO4	0	1	0
NaOH	0	0	1

Figure 1 Process Diagram pH Neutralization

The combination of the mixer and separator represents a surge tank. Generally, a surge tank would be used in a pH neutralization process to dampen flow and composition fluctuations, as well as to vent vapor release and to settle solids.

The neutralizer block then adds a reagent to adjust the pH of the liquid from that of the separator effluent liquid to the desired value.

The following instructions are designed to take you on a tour through some of the interesting features of the OLI Flowsheet: ESP Process Analysis facilities.

Starting the tour

Start OLI Flowsheet: ESP by either clicking the icon on the desktop or via the start menu options.

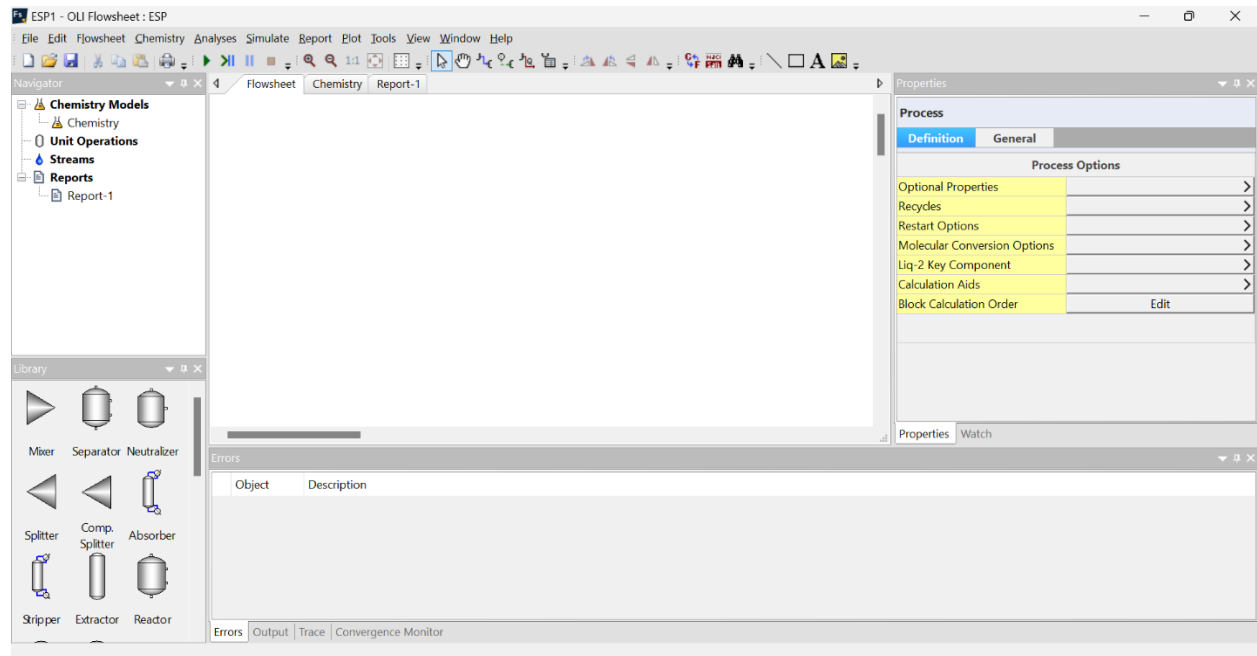

The standard layout

Let's begin by describing the various sections of the program.

The PFD (Process Flow diagram)

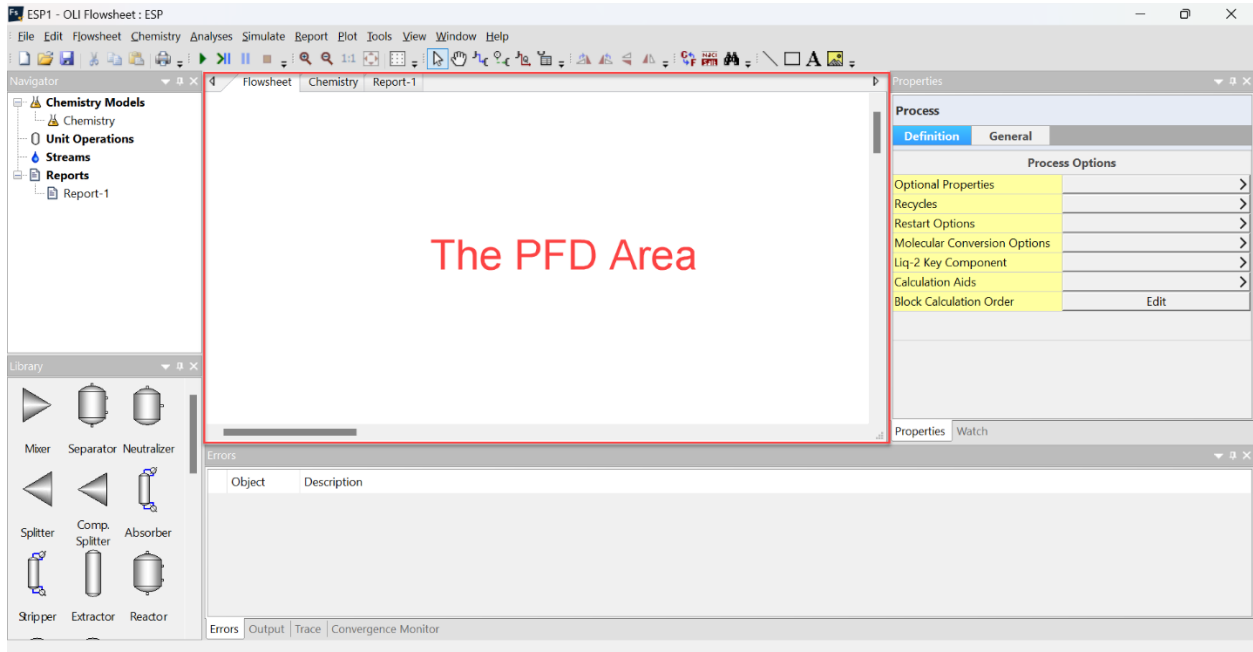

This is the area where we will build the process diagram. The tabs at the top are where we will define the chemistry and create our reports.

The Navigator Tree

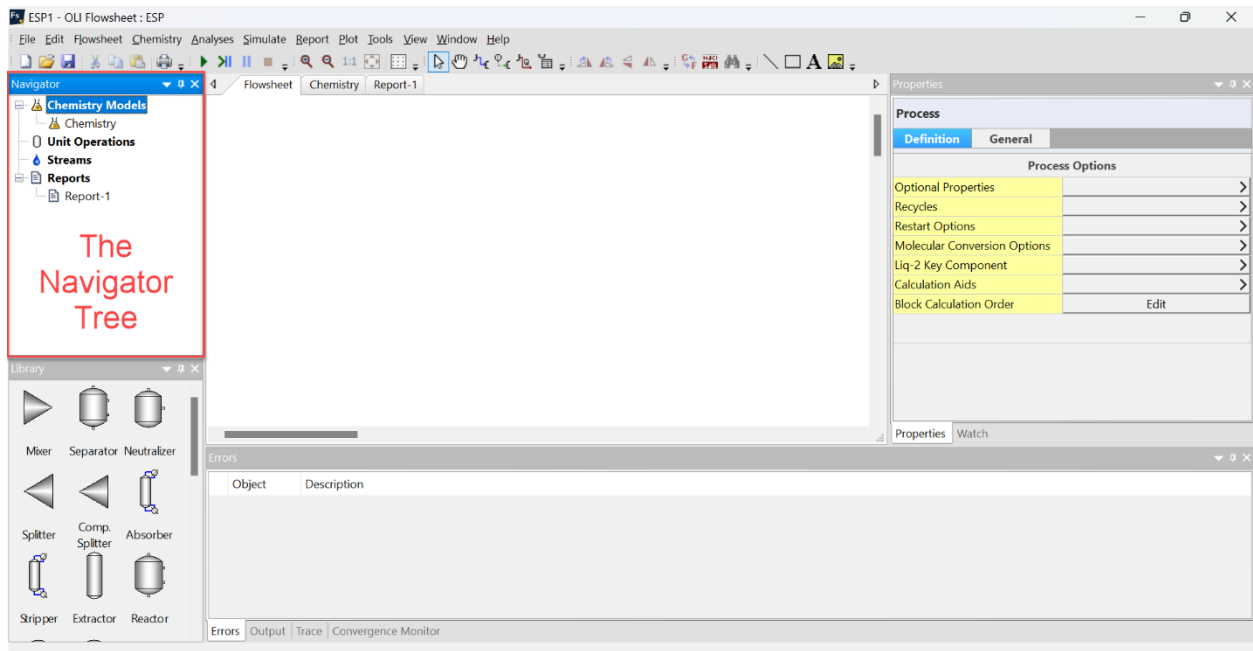

On this tree-view, we can see all the objects, reports, and chemistry models that exist in this document.

Unit Operations

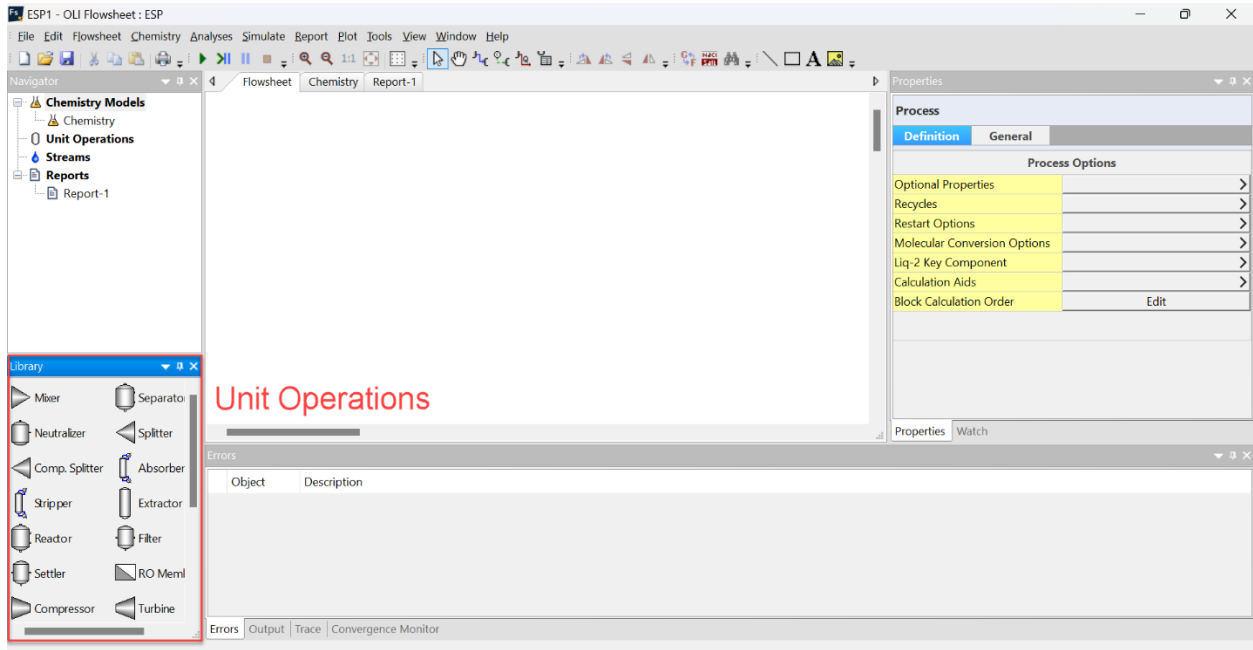

This is the palette of unit operations available in OLI Flowsheet: ESP. These will be described in more detail in the following chapters.

Properties

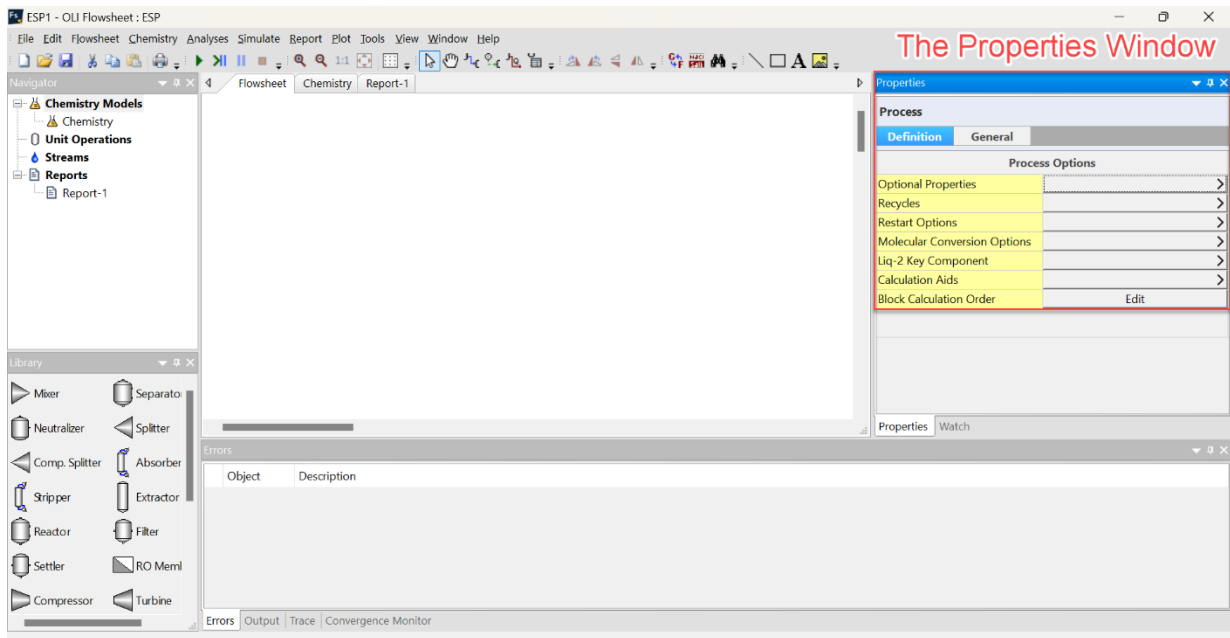

This window changes depending on the object highlighted. Right now, it is displaying options for the entire flowsheet.

The Trace Window (Optional)

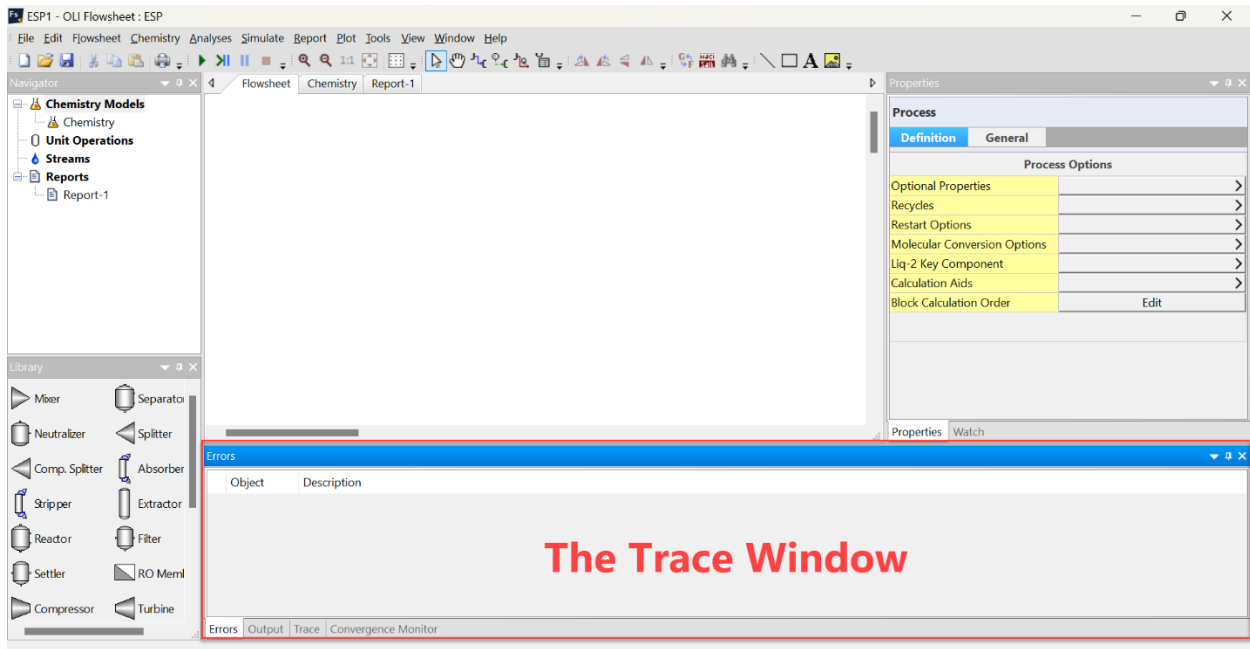

Various output messages about the state of the simulation are displayed here, including warnings, errors, and convergence messages.

Defining the chemistry for this application

To begin to define the chemistry for this application, we need to click on the **Chemistry Tab** located at the top of the PFD area.

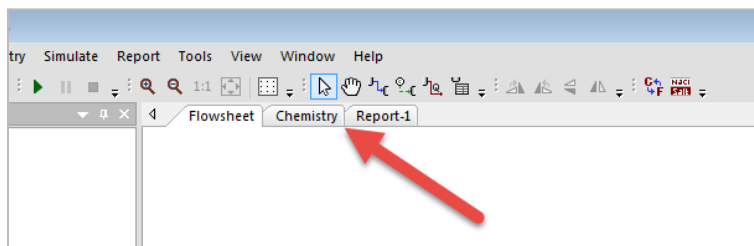

We can have multiple chemistry models in this application but for now we will only use a single model.

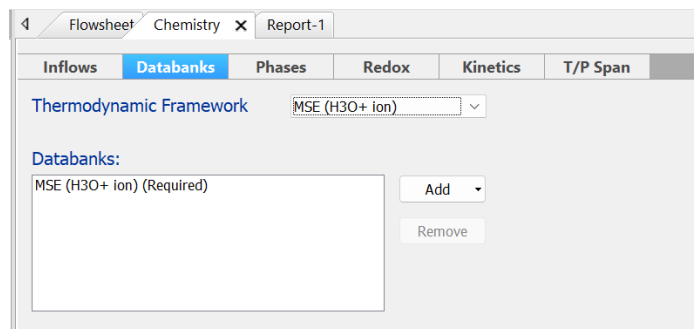

If you have used other OLI Software before, then many of the objects on this screen will be familiar to you. We will describe them here.

The default view of the chemistry tab is the **Databanks Tab**. Here we have several buttons and fields.

Thermodynamic Framework Drop-Down List

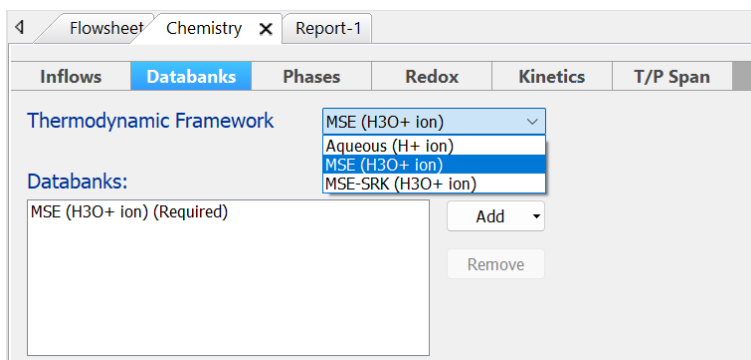

Here, we can choose the thermodynamic framework for the simulation. For this application, use the default **MSE (H3O+ ion)** framework.

Adding user/private databanks

The user can add some additional databanks or their own databanks. This is usually required when the default OLI databank is missing some components or OLI has recently made an interim release of new data and components. The currently selected databanks are displayed (MSE (H3O+ ion)¹ in this example), but additional databanks can be selected via the **Add** button.

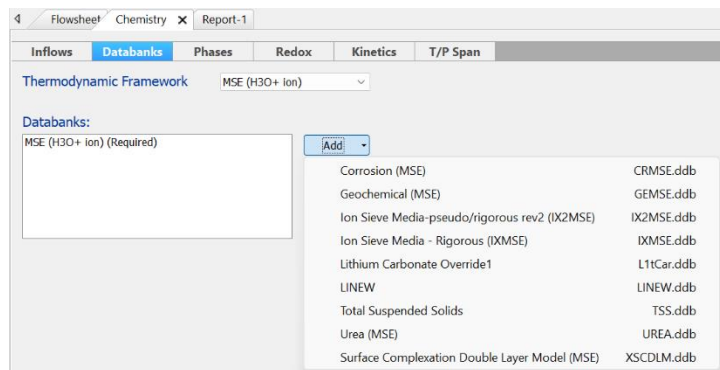

These databanks will be discussed in later chapters. For this application, do not select any additional databanks.

¹ Sometimes OLI will refer to this database as the MSEPUB or MSEPUBLIC database. The PUBLIC database is the default database for the AQ thermodynamic framework.

Creating the inflow chemistry

Now click on the **Inflows Tab** to enter the inflow list of components.

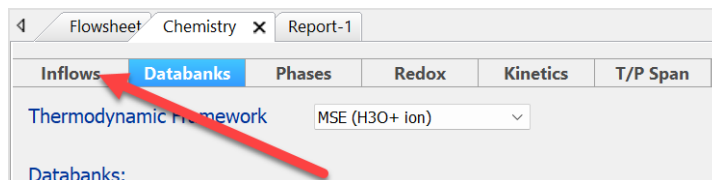

Entering components

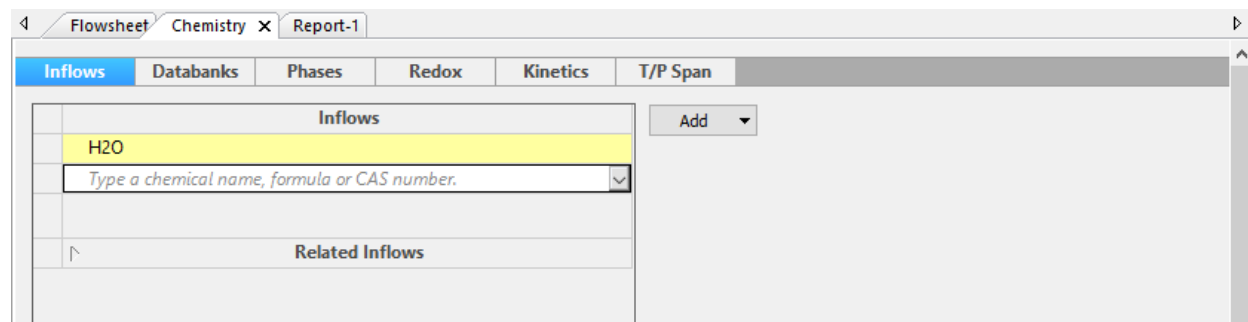

We can start to enter the name of our components. Experienced users of OLI software know that they can either type in the chemical formula or enter the OLI TAG name. In version 12, common component names can be entered as well. The inflow grid will automatically start to search for your components. We can also add special components such as petroleum assays and pseudo components via the **Add** button. This functionality will be discussed in later chapters.

For now, please enter the species formula for ammonia, **NH3**

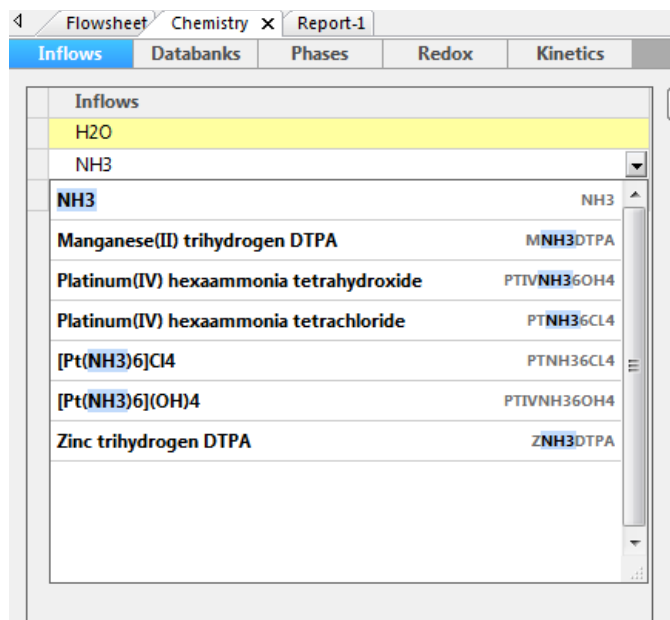

You can see that we automatically begin searching the selected databank for the characters “NH3.” There are several components to select; for this example, select the first entry, NH3.

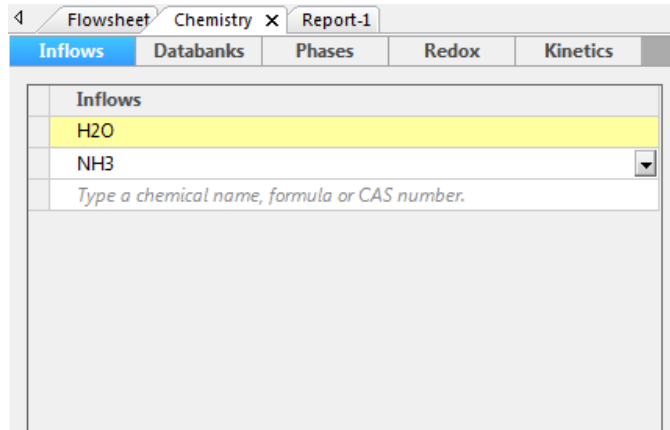

Now, please enter the remaining components for this application. These components are (enter each on a separate line):

CO2
SO2
HCl
H2SO4
NaOH

The grid should be like the image below when complete.

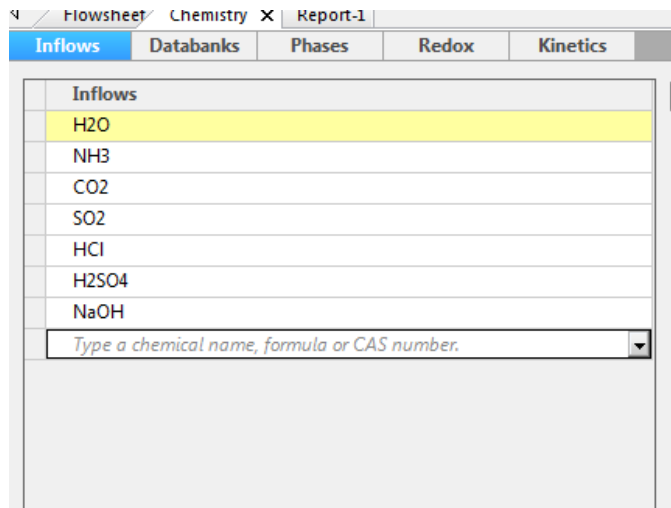

We can also modify the phase phenomena, oxidation and reduction chemistry, and reaction kinetics. We will leave this for later examples.

Building the process

We are ready to define the individual unit operations that make up the process shown in Figure 1 Process Diagram pH Neutralization on page 7

The first thing we should do is to click on the Flowsheet tab in the PFD area.

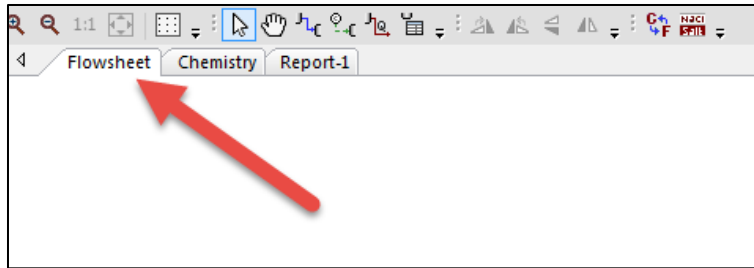

The **Mixer** is the first unit operation we need. Locate the **Mixer** in the unit operations library.

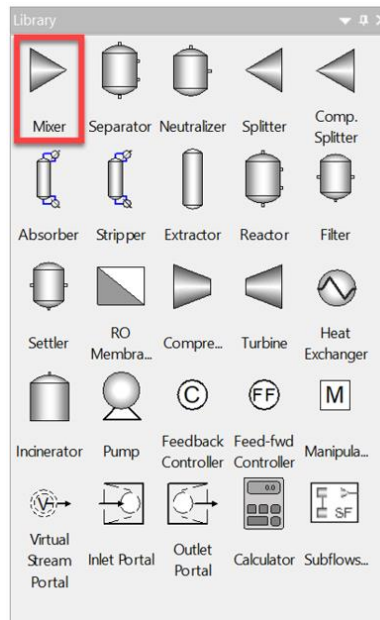

Double-clicking the object will add it to the PFD. Please note that the unit operation can also be dragged and dropped from the palette into the flowsheet area.

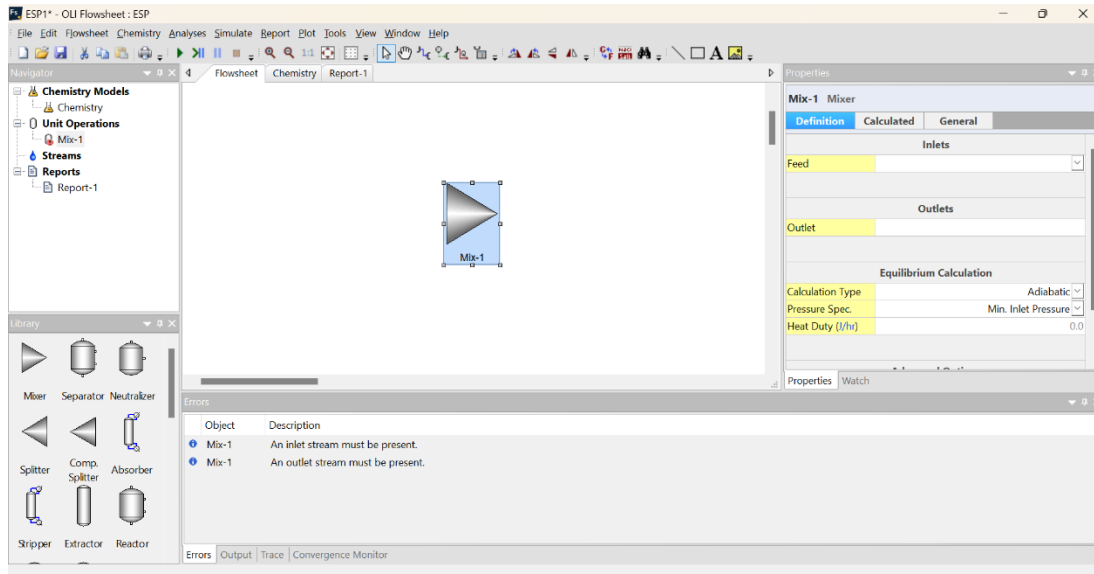

A lot of messages and properties suddenly became visible in the program. The object is centered on the PFD, but you can click and drag it where you want. Right now, it is acceptable where it is located. The **Properties** window has updated with some information. We will come back to this window. Right now, we need to add some streams. The mixer needs two inlets (although a single inlet is permitted) and a single outlet. To start adding streams, we need to **click** the streams icon above the PFD in the toolbar.

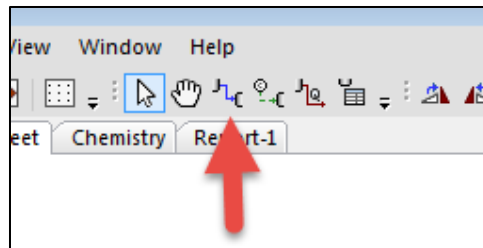

The Streams toolbar button

Now position the mouse pointer near the inlet side of the mixer.

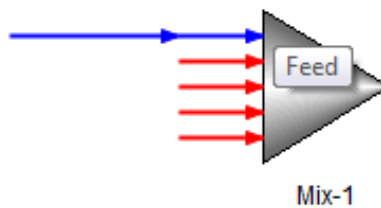

As you click and drag the inlet select streams become visible as red lines. Just drop the end of the stream onto the red line. Pressing the ESC key exits the add stream function if you so desire.

The screenshot shows a process simulation software interface. The main window displays a process block labeled "Mix-1" with a single inlet stream labeled "S-1". The "Properties" window on the right is open for stream "S-1", showing parameters such as Temperature (25.0 °C), Pressure (1.0 atm), and Total Flow (0.0 mol/hr). The "Inflows (mol/hr)" table lists various chemical species with zero flow rates.

Parameters	
Temperature (°C)	25.0
Pressure (atm)	1.0
Total Flow (mol/hr)	0.0

Inflows (mol/hr)	
H2O	0.0
NH3	0.0
CO2	0.0
SO2	0.0
HCl	0.0
H2SO4	0.0
NaOH	0.0
Total	0.0

Added stream with the properties window displayed.

At this point, you have some options. The desired stream name is “Base Waste,” and you can change it now or later. Some users prefer to change the name as they go and others after the blocks are connected.

For this example, we will complete adding the inlet and outlet streams.

Re-click the **Add Stream** toolbar button and add a second inlet stream and then an outlet stream. Your diagram should look like the following figure.

The screenshot shows the process simulation software interface with a process block labeled "Mix-1". It now has two inlet streams, "S-1" and "S-2", and one outlet stream, "S-3". The "Properties" window on the right is open for the process block, showing "Process Options" such as "Optional Properties", "Calculation Aids", "Recycles", "Restart Options", and "Molecular Conversion Weight".

Now let's change the stream names to match Figure 1 Process Diagram pH Neutralization on page 7. Like any good Windows-based program, there are several methods to accomplish this task. The first is to double-click the stream to enter you into edit mode. Double-click the stream S-1 (or whatever name currently exists).

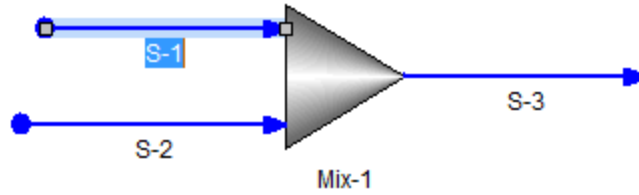

The name of the stream is highlighted. You can now just type the name you desire. In this case, please change the name to “Base Waste.”

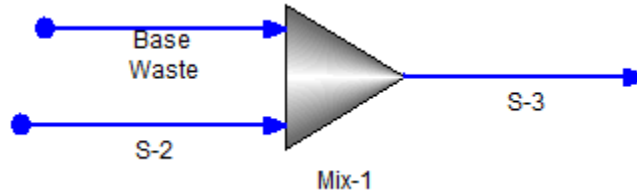

The text can be moved around to make the PFD more readable. We will do that in a later chapter.

The other method to change the name of a stream is to use the property window. In this case, just click the stream “S-2.”

Changing the stream name via the properties window

Click the **General** tab in the properties window for this stream.

S-2	
Definition	Calculated
Name	S-2
Created	Tue Sep 03 16:03:38 2019
Notes:	

Here you can rename the stream name “S-2” to “Acid Waste” as you would in any Windows program.

Acid Waste	
Definition	General
Name	Acid Waste
Created	Tue Sep 03 16:03:38 2019
Notes:	

Now for the remaining stream, change the name to “Mixed Waste” using either method.

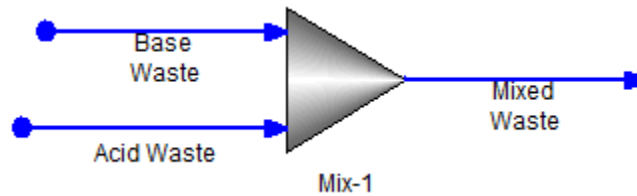

The fully named block

You can also rename the block itself using the same methods.

Now we need to define the composition of the streams and the operating conditions of the mixer. Click on the stream “Base Waste” and then click on the **Definition** tab in the properties window.

The composition of Base Waste is given in the Table below:

Stream Name	Base Waste
Temperature, °C	40.0
Pressure, Atm	1.0
Total Flow, mol/hr	200
Inflows, mol/hr	

H2O	55.51
NH3	1.0
CO2	0.1
SO2	0.1

Enter these values in the grid; notice that we have not entered any values for HCl, H2SO4 or NaOH.

Base Waste	
Definition	Calculated
Show Ionic Input Options	
Parameters	
Temperature (°C)	40.0
Pressure (atm)	1.0
Total Flow (mol/hr)	200.0
Inflows (mol/hr)	
H2O	55.51
NH3	1.0
CO2	0.1
SO2	0.1
HCl	0.0
H2SO4	0.0
NaOH	0.0
Total	56.71
Advanced Options	
Set Phase	No Special C...
Properties	Watch

A few comments about this stream; notice that the “Total Flow” and the “Total” do not match. This is by design. Many times, a user will know the total stream flow in a different unit such as kg/hour and the inflows in mass fractions. In that scenario, the two values do not match. What the internal numerical engine will do is normalize the inflows to match the total flow.

Please enter the composition for the stream “Acid Waste” in the same manner.

Stream Name	Acid Waste
Temperature, °C	25.0
Pressure, Atm	1.0
Total Flow, mol/hr	150

Inflows, mol/hr	
H2O	55.51
HCl	0.1
H2SO4	1.0

Now we are ready to define the unit operation parameters.

Click on the mixer block.

The screenshot shows a process simulation software interface. On the left, a flowsheet diagram displays a mixer block labeled 'Mix-1'. Two inlet streams, 'Base Waste' and 'Acid Waste', enter the mixer from the left. A single outlet stream, 'Mixed Waste', exits the mixer to the right. On the right side, the 'Properties' window for the 'Mix-1 Mixer' is open. It has two tabs: 'Definition' and 'General'. The 'General' tab is active and shows the following settings:

- Inlets:** Three 'Feed' entries with dropdown menus set to 'Base Waste', 'Acid Waste', and an empty dropdown.
- Outlets:** One 'Output' entry with a dropdown menu set to 'Mixed Waste'.
- Equilibrium Calculation:**
 - Calculation Type: Adiabatic
 - Pressure Spec.: Min. Inlet Pressure
 - Heat Duty (cal/hr): 0.0
- Advanced Options:**
 - Chemistry Model: Chemistry (Default)

In the properties window, we have several options. These options differ for each type of unit operation. We can see the names of the inlet streams and outlet streams. We can use the drop-down arrows to select different streams if required.

Please look at the section labeled “Equilibrium Calculation.” Here we can set some basic parameters for a mixer block.

Calculation Type

Equilibrium Calculation	
Calculation Type	Adiabatic
Pressure Spec.	Adiabatic
Heat Duty (cal/hr)	Isothermal Bubble Point Dew Point Vapor Target Isochoric

We can have several types of calculations for a mixer. These will be described in detail in a later chapter. The default mixer type is “Adiabatic” which means the heat out of the block equals the sum of the heat into the block (duty = 0) and the temperature is calculated to meet that condition.

For this example, we will leave the **Calculation Type** at the default value of “Adiabatic.”

Pressure Spec.

Equilibrium Calculation	
Calculation Type	Adiabatic
Pressure Spec.	Min. Inlet Pressure
Heat Duty (cal/hr)	Min. Inlet Pressure
	Absolute Pressure
	Pressure Drop

Many unit operations have pressure options, and these often depend on the type of calculation being specified. For our example, we will leave the default value of “Min. Inlet Pressure” which means we will survey the inlet streams and use the smallest value. In this example, the inlet streams both have a pressure of 1.0 atmosphere so that will be the pressure used.

Heat Duty

Equilibrium Calculation	
Calculation Type	Adiabatic
Pressure Spec.	Min. Inlet Pressure
Heat Duty (cal/hr)	0.0

For adiabatic type calculations (where the temperature is calculated) we can add some type of offset value. This is a rare calculation, so we will use the default value of 0.0.

Running the calculation

We have partially completed the process. There are several schools of thought on how to build a process. Some want to lay out the process first, then run the simulation. Others will build the process in parts and run each part. Both have advantages and disadvantages.

For this simulation, we will run the simulation for our partially completed process.

To run this simulation, please look for the “run button” in the toolbar.

Click the run button to run the simulation.

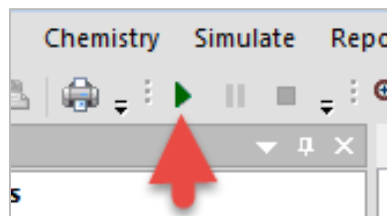

The screenshot displays the ESP1* - OLI Flowsheet: ESP software interface. The main window shows a process flow diagram with a central mixer unit labeled 'Mix-1'. Two input streams, 'Base Waste' and 'Acid Waste', enter the mixer from the left, and one output stream, 'Mixed Waste', exits to the right. The interface includes a Navigator pane on the left with a tree view showing 'Chemistry Models', 'Unit Operations' (containing 'Mix-1'), 'Streams' (containing 'Acid Waste', 'Base Waste', and 'Mixed Waste'), and 'Reports' (containing 'Report-1'). A Library pane at the bottom left contains icons for various units: Mixer, Separator, Neutralizer, Splitter, Comp. Splitter, Absorber, Stripper, Extractor, and Reactor. The Properties pane on the right is open for the 'Mix-1 Mixer' unit, showing tabs for 'Definition', 'Calculated', and 'General'. The 'Definition' tab is active, displaying 'Inlets' (Feed 1: Base Waste, Feed 2: Acid Waste) and 'Outlets' (Outlet: Mixed Waste). The 'Equilibrium Calculation' section shows 'Calculation Type' set to 'Adiabatic', 'Pressure Spec.' set to 'Min. Inlet Pressure', and 'Heat Duty (l/hr)' set to 0.0. The Errors pane at the bottom is empty, and a 'Simulation Complete' notification is visible in the bottom right corner.

The simulation has been completed successfully.

Obtaining preliminary results

Now that we have a converged simulation, we can obtain some results. These may not be (and probably will not be) the final results, but it is a good idea to investigate our preliminary results to see if they are reasonable. For example, we expect our “Acid Waste” stream to have low pH values and similarly the “Base Waste” stream to have high pH values.

Click on the **Report-1** tab at the top of the PFD area (note: the “-1” means that it is the first report for this document; the number may change).

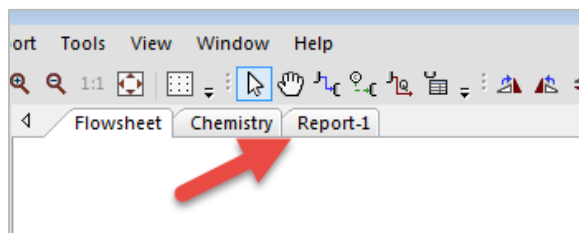

This will display a report where the stream of interest needs to be selected first, before any information is shown.

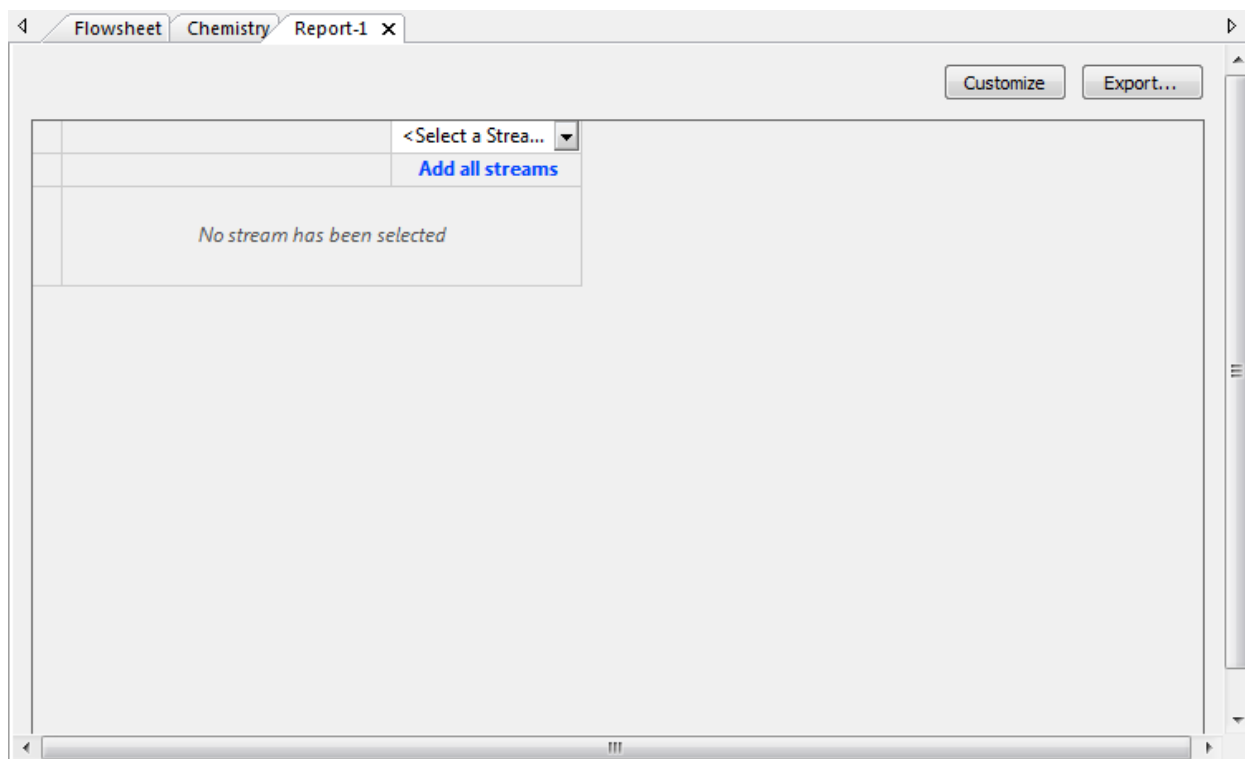

We have many options here. We can see a single stream, multiple streams, or all the streams. The process, currently, only has three streams. Click the **Add All Streams** hyperlink.

	Base Waste	Acid Waste	Mixed Waste	<Select a Stream...>
	Remove	Remove	Remove	Add all streams
Stream Parameters				
Temperature (°C)	40.0	25.0	38.856	
Pressure (atm)	1.0	1.0	1.0	
pH	9.34	-0.0811162	1.21395	
Total Dissolved Solids, Estimated (mg/L)	19331.7	1.19952e5	56954.4	
Hardness (mg/L as CaCO ₃)	0.0	0.0	0.0	
Moles, True (mol/hr)	197.556	150.0	349.932	
Moles, Apparent (mol/hr)	200.0	152.65	352.65	
Mass (g/hr)	3625.02	2919.34	6544.36	
Volume (L/hr)	3.62225	2.7492	12.985	
Phase Flows				
Moles, TrueLiquid-1 (mol/hr)	197.556	150.0	349.673	
MolesSolid (mol/hr)	0.0	0.0	0.0	
MolesVapor (mol/hr)	0.0	0.0	0.259083	
Moles, ApparentLiquid-1 (mol/hr)	200.0	152.65	352.391	
MassLiquid-1 (g/hr)	3625.02	2919.34	6533.12	
MassSolid (g/hr)	0.0	0.0	0.0	

This report is a table. It can be copied and pasted into another program such as Microsoft Word or Excel. You can use the **Export** button to create a CSV file for direct import into Excel. Right now, we will not dwell on too much of the contents since we have more unit operations to add. You can see, however, that our “Base Waste” and “Acid Waste” streams have pH values representative of the type of stream that they are.

Finishing the application

We will now finish the application by adding the remaining Separator and Neutralizer.

Click back on the **Flowsheet** tab above the PFD. From the **Library** please double-click the **Separator** unit operation.

Adding a separator block

You can see that double-clicking the unit operation puts it dead center in the PFD. There is a slightly better method of adding a block which we will show you with the neutralizer. Drag the separator to the right of the mixer. Notice that a warning has appeared informing you that the process definition has changed. Click the **Dismiss** button.

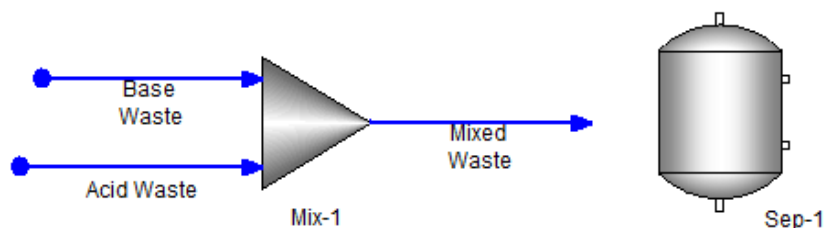

Now this part is tricky; click the arrowhead at the end of the stream “Mixed Waste” and drag it towards the separator “Sep-1.”

As you get close to the separator, the inlet streams become live.

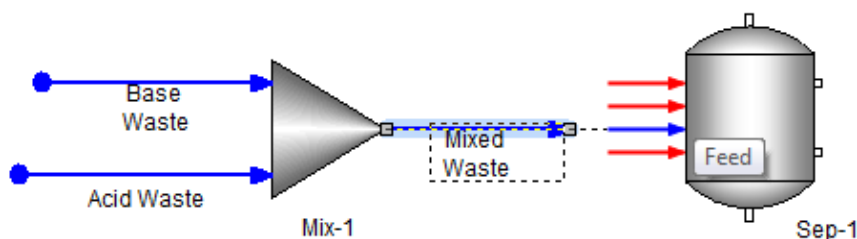

Connect the “Mixed Waste” stream to any inlet stream.

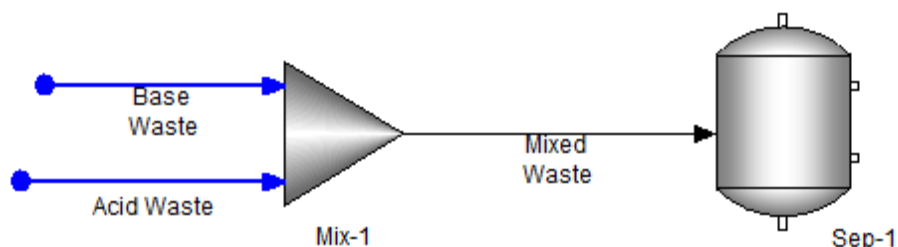

Notice now that the connected stream went from blue (which indicates an inlet or outlet stream) to a thin black line. Thin black lines represent internal streams. Blue lines with a dot on the end are inlet streams, and blue lines with just an arrowhead are outlet streams.

As we did with the mixer, we now need to add the outlet streams using the stream toolbar. Connect a line at the top, sides, and bottom.

You will notice that as you add streams to a separator block, we display some tags.

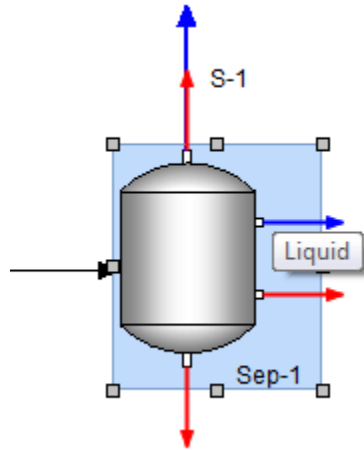

Displaying stream tags

These tags tell you what kind of stream is expected for that outlet port. The top stream is expected to be vapor, and the bottom is solids. The top-most side stream is a liquid (water-rich), and the bottom-most side stream is an organic stream (hydrocarbon-rich). We will discuss separators in more detail in later chapters.

The completed separator unit block now looks like this:

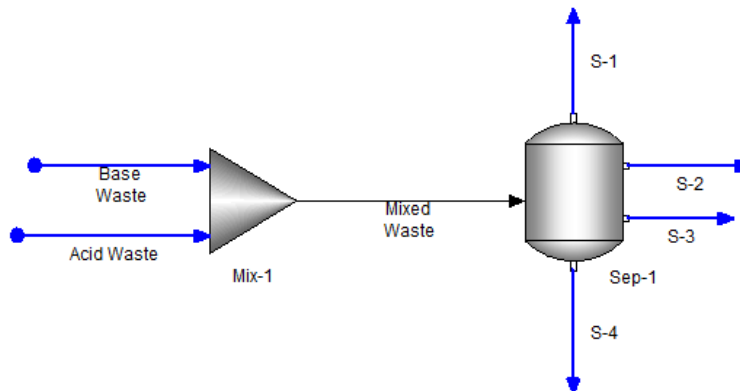

We have started re-using the original stream names. We need to rename these streams according to the process design for pH neutralization shown on page 7.

Separator Stream Definitions – Sep-1	
Line	Name
Vapor	Sep Vapor
Liquid	Sep Liq
Organic	Sep Org
Solid	Sep Solid

Using the methods outlined for the mixer, change the name as indicated in the above table.

The separator also has its own properties which need to be defined. The separator also supports all the mixer calculations plus some entrainment options. We will not change any of these properties. The block properties are shown below (we will use this table format for future examples).

Block Properties – Sept-1	
Block Type	Separator
Block Name	Sep-1
Equilibrium Calculation	
Calculation Type	Adiabatic (default)
Pressure Spec.	Min. Inlet Pressure (default)
Duty	0.0 (default)
Entrainment (sub-menu)	All values are default

We will now add the final block which is a neutralizer block. Locate the neutralizer block from the **Library** (you may need to scroll down to locate it).



This time, do not double-click the block. Click and then drag it to the PFD.

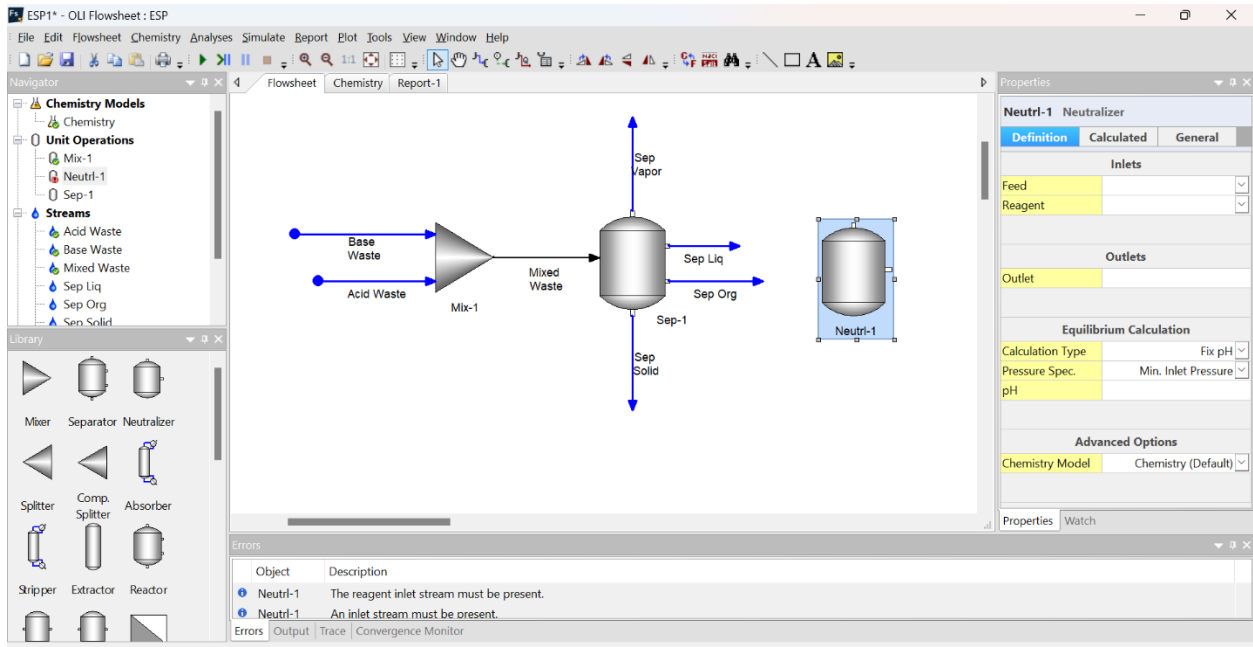

This is not a very convenient place to locate the block. Using the scroll bars move the entire PFD to the left (scrolling right):

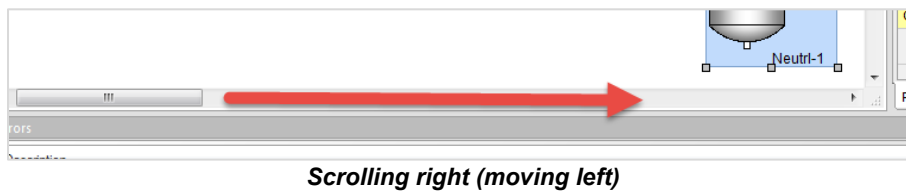

Now drag the neutralizer up a bit to be in line with the other blocks.

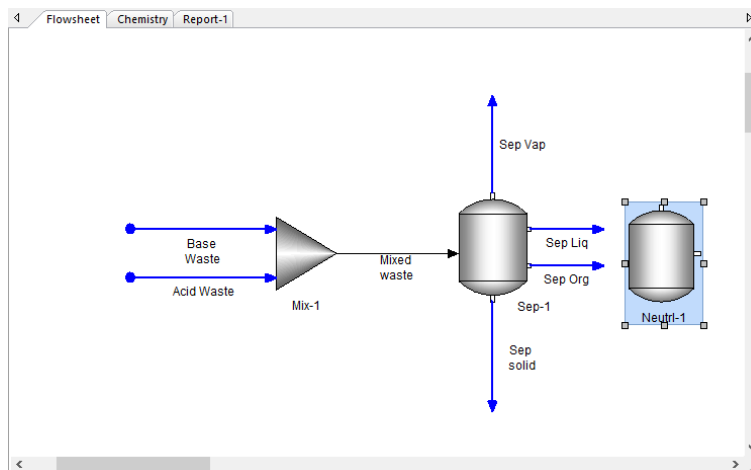

As with the separator, drag the stream “Sep Liq” to the neutralizer and connect to an inlet. Then add a new inlet stream to the top of the neutralizer. Rename the new inlet stream to “Caustic Reagent” and create an outlet stream named “Neutralized Liq.”

The process should look like the one shown in the figure below:

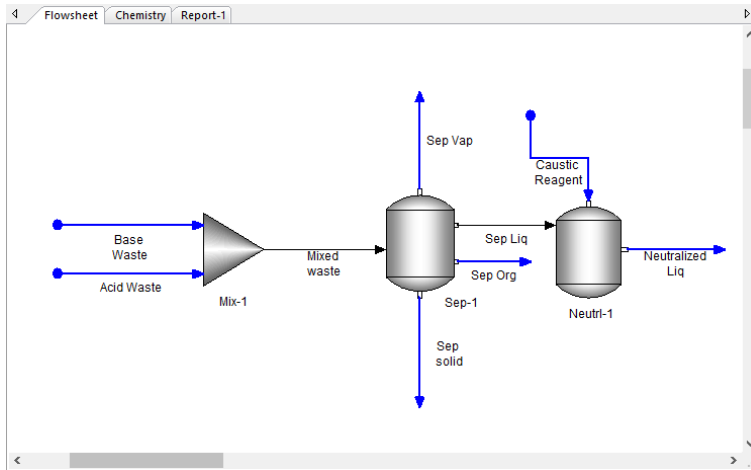

Now let's finish adding the component inflows and block properties.

Stream Name	Caustic Reagent
Temperature, °C	30.0
Pressure, Atm	1.0
Total Flow, mol/hr	100
Inflows, mol/hr	
H2O	55.51
NaOH	1.0

Now we will enter the block properties for the neutralizer. The **Calculation Type** defaults to "Fix pH" for the neutralizer block. If it is not this option, you can change it by using the drop-down menu to find the correct setting:

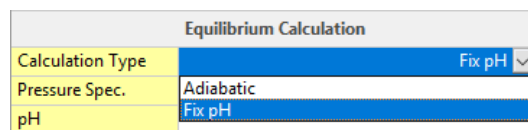

Block Type	Neutralizer
Block Name	Neutr1-1
Equilibrium Calculation	
Calculation Type	Fix pH
Pressure Spec.	Min. Inlet Pressure (default)
pH	9.0

Running the final simulation design

We are now ready to run the simulation for the final design. However, good computing practices dictate that we should save the simulation before we run it.

Click the **File | Save** menu item or use the Save toolbar button. This function is the same as the standard Windows conventions. Save the file in a folder where you remember the location.

OLI recommends the name “**Neutral1-basic design**” as the file name. The file type is “ESP”.

Click the run button.

Once complete, please click on the **Report-1** tab. The original list of streams will still be there and updated with new data if necessary. As we did previously, please click the **Add all streams** hyperlink.

We can modify the current report to display or hide streams and contents. If you are already familiar with OLI Studio, then you know much about the report sections for each stream. We previously looked at the streams “Base Waste” and “Acid Waste.” These streams are straightforward to analyze, and we will not look at them here.

Click the **Remove** hyperlink under those streams to remove them from the report. You should have a screen like the following (you may need to scroll left or right to see all the values depending on your screen resolution).

	Base Waste	Acid Waste	Mixed Waste	Sep Liq	Sep Org	Sep Vapor	Sep Solid	Caustic Reagent	Neutralized Liq	<Select a Strea...
	Remove	Remove	Remove	Remove	Remove	Remove	Remove	Remove	Remove	Add all streams
Stream Parameters										
Temperature (°C)	40.0	25.0	38.856	38.856	38.856	38.856	38.856	30.0	39.7193	
Pressure (atm)	1.0	1.0	1.0	1.0	1.0	1.0	1.0	1.0	1.0	
pH	9.34	-0.0811162	1.21395	1.21395				13.6224	9.0	
Total Dissolved Solids, Estimated (mg/L)	19331.7	1.19952e5	56954.4	56954.4				39916.0	40369.6	
Hardness (mg/L, as CaCO3)	0.0	0.0	0.0	0.0				0.0	0.0	
Moles, True (mol/hr)	197.556	150.0	349.932	349.673	0.0	0.259083	0.0	248.96	597.114	
Moles, Apparent (mol/hr)	200.0	152.65	352.65	352.391	0.0	0.259083	0.0	244.631	597.022	
Mass (g/hr)	3625.02	2919.34	6544.36	6533.12	0.0	11.2382	0.0	4502.29	11035.4	
Volume (L/hr)	3.62225	2.7492	12.985	6.38528	0.0	6.59976	0.0	4.33782	10.7837	
Phase Flows										
Moles, TrueLiquid-1 (mol/hr)	197.556	150.0	349.673	349.673	0.0	0.0	0.0	248.96	597.114	
MolesSolid (mol/hr)	0.0	0.0	0.0	0.0	0.0	0.0	0.0	0.0	0.0	
MolesVapor (mol/hr)	0.0	0.0	0.259083	0.0	0.0	0.259083	0.0	0.0	0.0	
Moles, ApparentLiquid-1 (mol/hr)	200.0	152.65	352.391	352.391	0.0	0.0	0.0	244.631	597.022	
MassLiquid-1 (g/hr)	3625.02	2919.34	6533.12	6533.12	0.0	0.0	0.0	4502.29	11035.4	
MassSolid (g/hr)	0.0	0.0	0.0	0.0	0.0	0.0	0.0	0.0	0.0	
MassVapor (g/hr)	0.0	0.0	11.2382	0.0	0.0	11.2382	0.0	0.0	0.0	
VolumeLiquid-1 (L/hr)	3.62225	2.7492	6.38528	6.38528	0.0	0.0	0.0	4.33782	10.7837	
VolumeSolid (L/hr)	0.0	0.0	0.0	0.0	0.0	0.0	0.0	0.0	0.0	
VolumeVapor (L/hr)	0.0	0.0	6.59976	0.0	0.0	6.59976	0.0	0.0	0.0	
Phase Fraction										
Mole Fraction, TrueLiquid-1 (mole %)	100.0	100.0	99.926	100.0	0.0	0.0	0.0	100.0	100.0	
Mole Fraction, TrueSolid (mole %)	0.0	0.0	0.0	0.0	0.0	0.0	0.0	0.0	0.0	
Mole Fraction, TrueVapor (mole %)	0.0	0.0	0.0740381	0.0	0.0	100.0	0.0	0.0	0.0	

Notice that the “Moles, True (mol/hr)” line for the streams “Sep Org” and “Sep Solid” equals zero (0.0). This means that these streams have zero content. For this analysis, we can remove these streams from the report by clicking the **Remove** link.

We now have a much more reasonable list. Going back to the flowsheet process presented on page 7, we see the original flowrate of the “Caustic Reagent” stream was 100 mol/hr. The value now is 244.6 mol/hr.

	Base Waste	Acid Waste	Mixed Waste	Sep Liq	Sep Vapor	Caustic Reagent	Neu
	Remove	Remove	Remove	Remove	Remove	Remove	
Stream Parameters							
Temperature (°C)	40.0	25.0	38.856	38.856	38.856	30.0	
Pressure (atm)	1.0	1.0	1.0	1.0	1.0	1.0	
pH	9.34	-0.0811162	1.21395	1.21395			13.6224
Total Dissolved Solids, Estimated (mg/L)	19331.7	1.19952e5	56954.4	56954.4			39916.0
Hardness (mg/L as CaCO ₃)	0.0	0.0	0.0	0.0			0.0
Moles, True (mol/hr)	197.556	150.0	349.932	349.673	0.259083		248.96
Moles, Apparent (mol/hr)	200.0	152.65	352.65	352.391	0.259083		244.631
Mass (g/hr)	3625.02	2919.34	6544.36	6533.12	11.2382		4502.29
Volume (L/hr)	3.62225	2.7492	12.985	6.38528	6.59976		4.33782
Phase Flows							
Moles, TrueLiquid-1 (mol/hr)	197.556	150.0	349.673	349.673	0.0		248.96
MolesSolid (mol/hr)	0.0	0.0	0.0	0.0	0.0		0.0
MolesVapor (mol/hr)	0.0	0.0	0.259083	0.0	0.259083		0.0
Moles, ApparentLiquid-1 (mol/hr)	200.0	152.65	352.65	352.391	0.0		244.631
MassLiquid-1 (g/hr)	3625.02	2919.34	6533.12	6533.12	0.0		4502.29
MassSolid (g/hr)	0.0	0.0	0.0	0.0	0.0		0.0
MassVapor (g/hr)	0.0	0.0	11.2382	0.0	11.2382		0.0
VolumeLiquid-1 (L/hr)	3.62225	2.7492	6.38528	6.38528	0.0		4.33782

Why is it different from the input? The Neutralizer block has a target pH of 9.0. We can see from the streams that the “Sep Liq” stream has a pH of 1.21 so it will take some titrating of the caustic stream to raise it to 9.0.

Why did we look at the **Apparent** value instead of the **True** value? The true value is the sum of all species in the stream: vapor, solids, neutrals, and ions. The apparent value has the ions converted back into neutral species and better compares to the neutral inputs we originally used.

Later chapters will have a more complete discussion.

Once again, time to save your work.

A tour of OLI Flowsheet: ESP – Some Advanced Features

In this application, we will continue to use the example process Neutral1-basic design, but we will add a pH control loop rather than the neutralizer block. We frequently use a control loop for pH in cases where the set point of the controller is near the equivalence point of the solution (an area in which mathematical solutions are difficult to obtain).

We will be reusing portions of the **NEUTRAL1** process² described. The revised process diagram can be seen in the figure below.

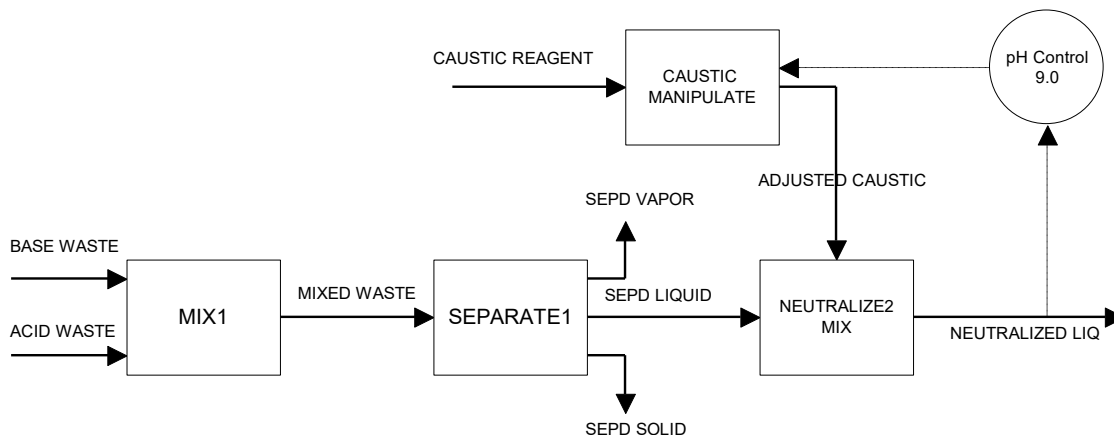

Neutralization Process with Manipulate/Mix Block and pH Controller

Let's save the file with a new name so we have the older file as a reference. Using the standard Windows tools, save the file with the name Neutral 1 – pH controller.

Locate the Neutrl-1 block on the existing PFD.

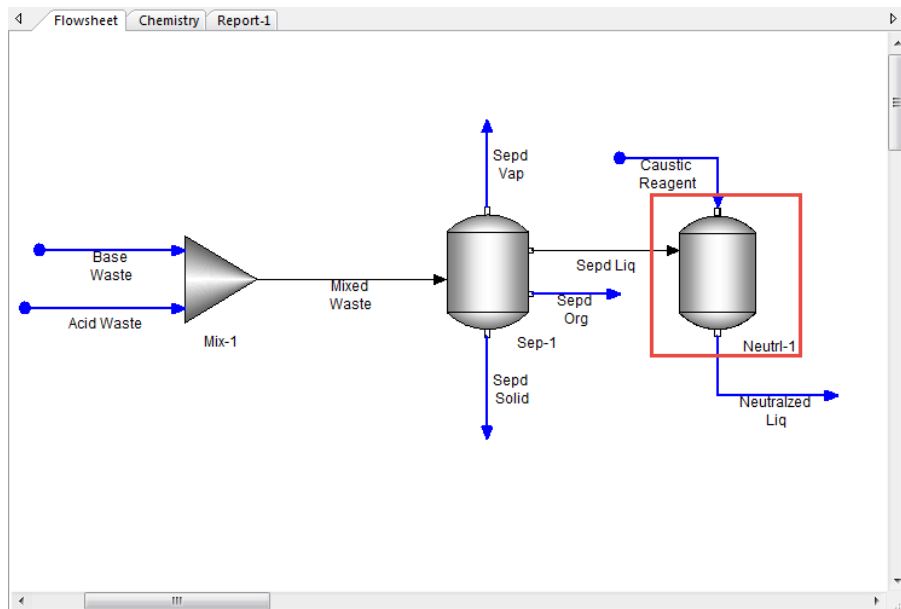

²Or the name you supplied.

Press the delete key to remove this block.

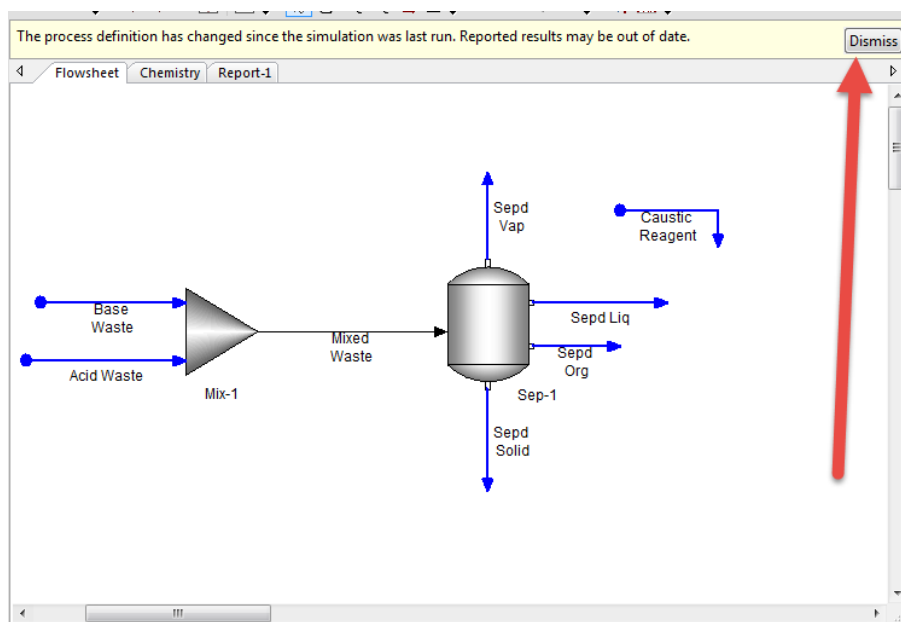

Two things have happened at this point. First, the old neutralizer has been deleted but the associated inlet stream remains on the PFD. In addition, a warning has appeared to remind you that the process has been modified. To proceed, please click the **Dismiss** button at the top of the PFD.

We have several options now. You can either add the manipulator block as described above or start with a mixer. Either is acceptable. For this tour, we will first add the new mixer and call it a neutralizer.

Select a **Mixer** from the library and drag it to approximately the same location as the old neutralizer.

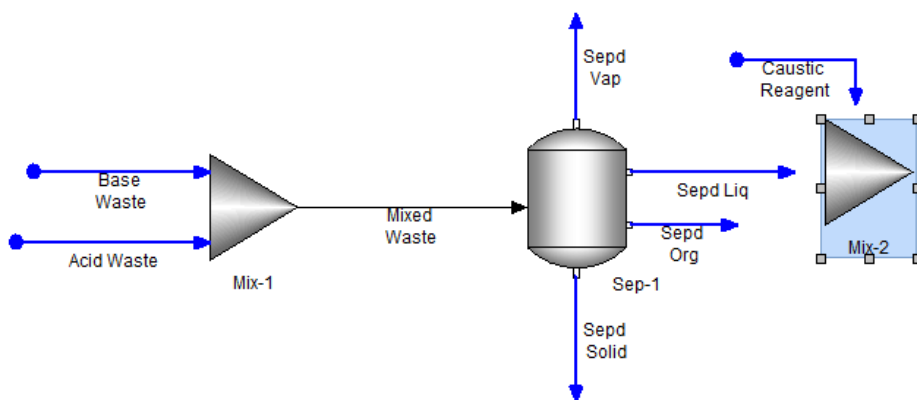

Change the parameters for the mixer as described in the following table:

Block Type	Mixer
Block Name	Neutrl-1
Inlet(s)	Sep Liq
Outlet(s)	Neutralized Liq
Equilibrium Calculation	
Calculation Type	Adiabatic

Pressure Spec.	Min. Inlet Pressure
Heat duty	0.0
Advanced Options	
Chemistry Model	Chemistry (Default)

The PFD is now updated like this:

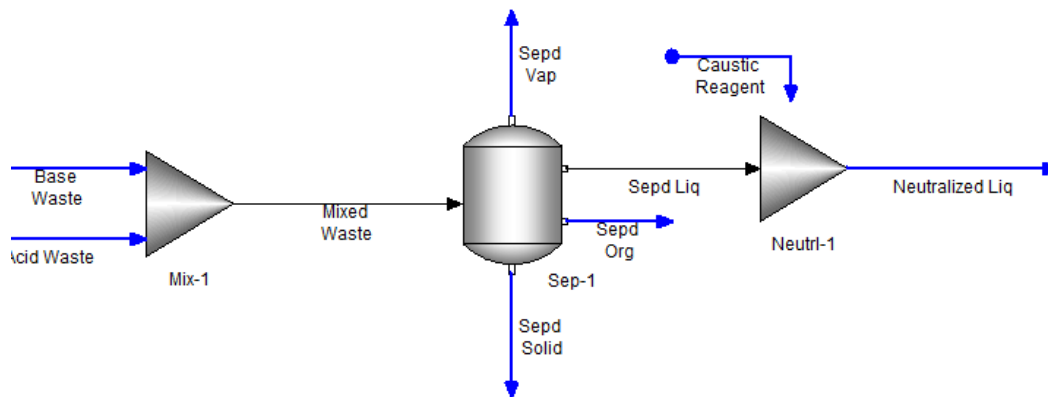

We now need to add a manipulator block. Manipulate blocks are very simple in operation. Either the total flow of the inlet stream is multiplied by some factor or a specific component in the stream is *multiplied* by a factor. This factor can be controlled by a *Controller Block*.

Locate the **Manipulate** block from the library and then drag it to the PFD above the **Neutri-1** block.

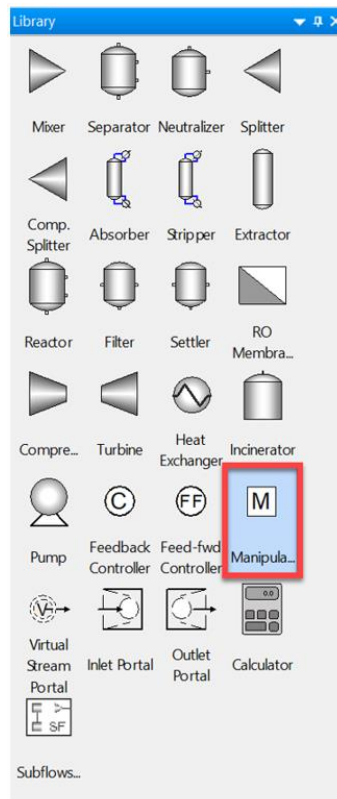

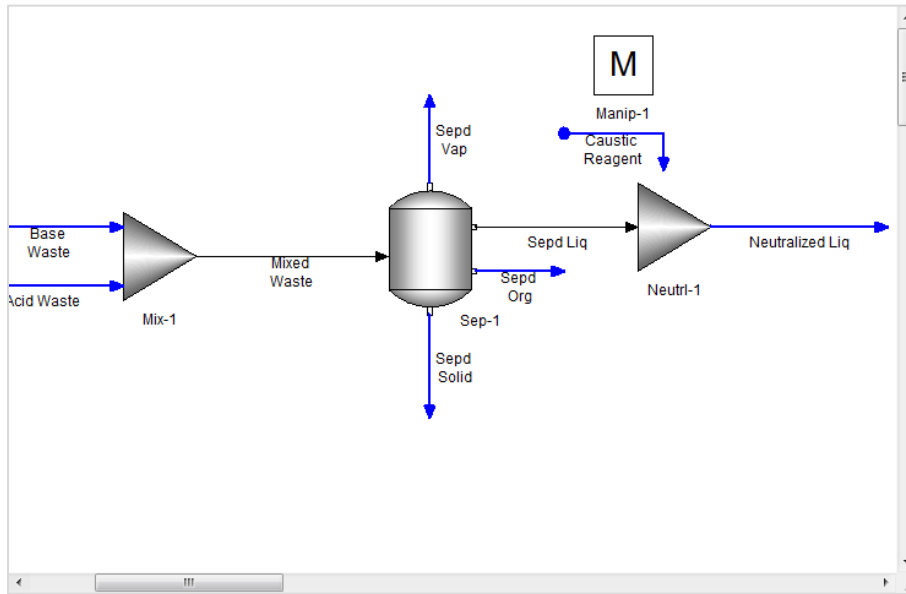

We will now connect the **Caustic Reagent** stream to the manipulate block and add an outlet stream which will be named **Adjusted Caustic**. See Table below for manipulator parameters:

Block Type	Manipulator
Block Name	Manip-1
Inlet(s)	Caustic Reagent
Outlet(s)	Adjusted Caustic
Parameters	
Manipulation Type	Total Flow
Factor, Flow	1.0
Advanced Options	
Chemistry Model	Chemistry (Default)

The PFD should be updated as follows:

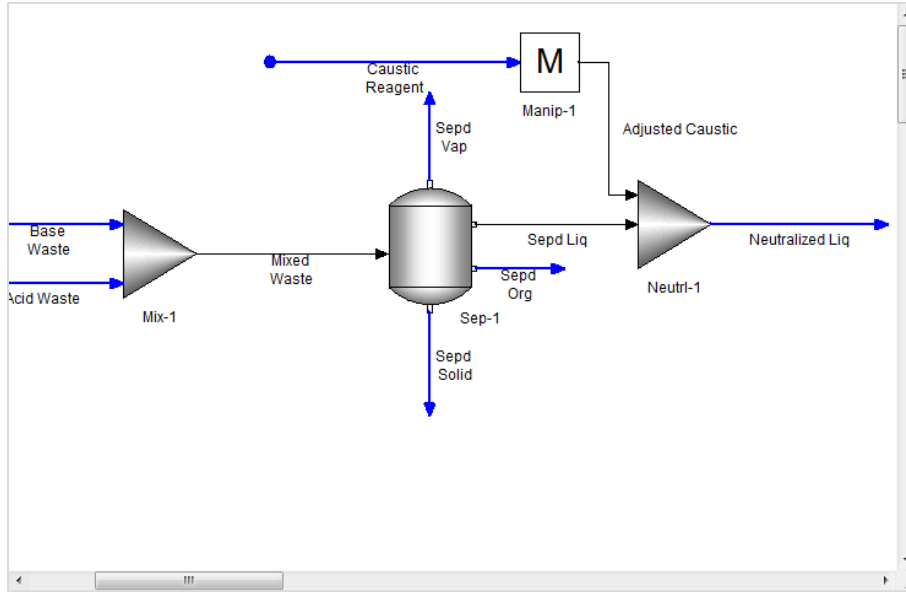

You may notice that we have moved blocks and streams around to make it easier to read the PFD. We will now add the final block for this process which is a control block. Locate the feedback controller from the library.

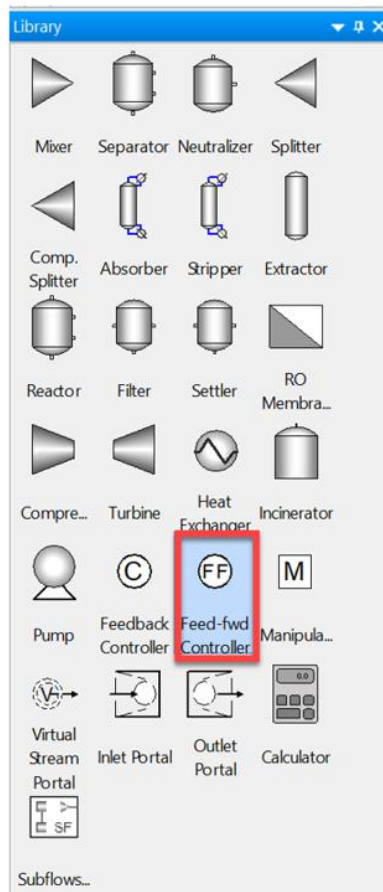

Now drag this block slightly above and to the right of the mixer "Neutri-1"

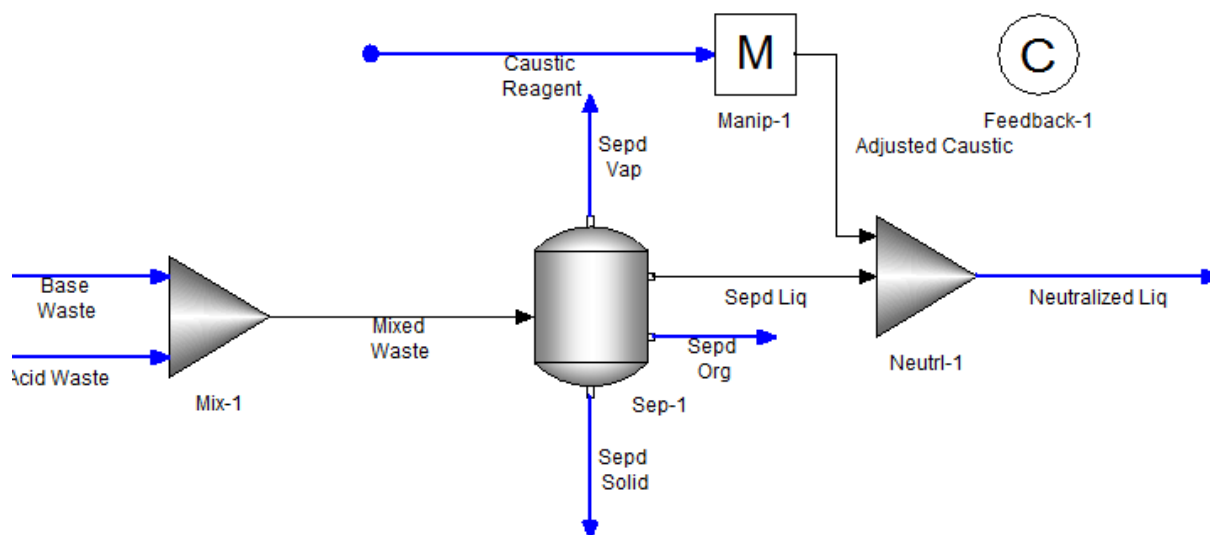

The connections to the controller are different than those of other blocks. The connections only carry information and not mass and energy. These connections are made with a different tool in the toolbar.

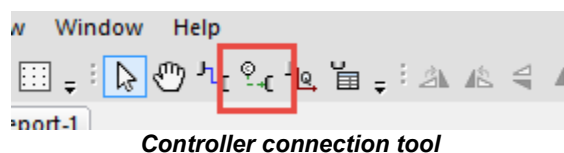

When you select this tool, you can drag lines from the measured object (usually a stream) to the controller and from the controller to the object under control (usually a block). Target points will appear when you drag the controller connector to the object.

Click the **Controller Connector** and drag a line from the stream **Neutralized Liq** to the **Feedback-1** controller.

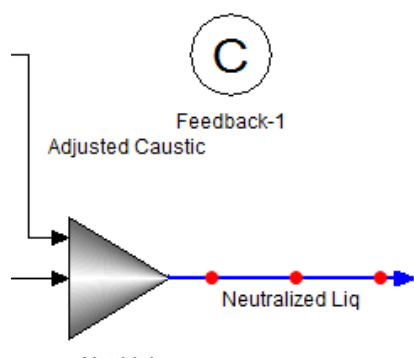

As the controller connection approaches, targets appear. Select any one of them.

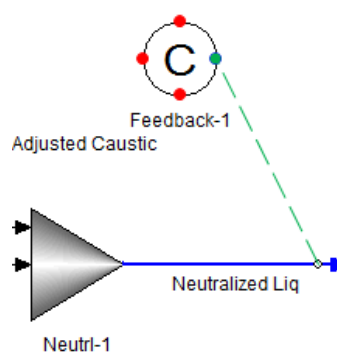

As the controller connect approaches the Feedback-1 block, new targets appear

Complete the connections by dragging a line from the **Feedback-1** controller to the **Manip-1** block.

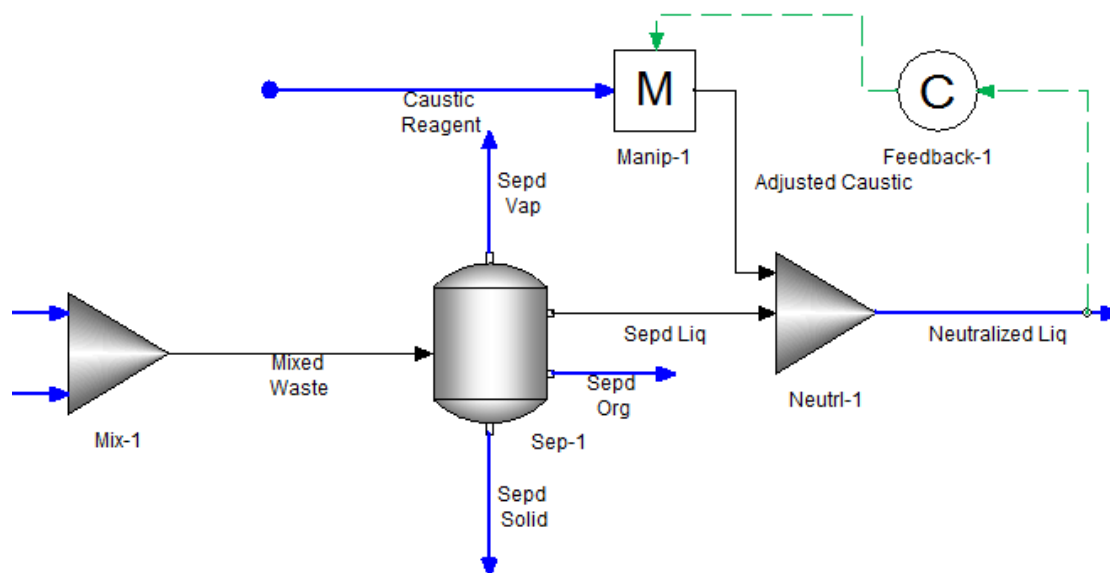

The connected feedback controller

We now need to define the parameters for the feedback controller.

Block Type	Feedback Controller
Block Name	Feedback-1
Target Specification	
Target Stream	Neutralized Liq
Spec. Type	pH
Target Value	9.0
Control Parameters	
Controlling Block	Manip-1
Block Parameter	Factor, Flow
Options	
Calculate After	<Automatic>
Convergence Options	Fly Out Menu (all default)

We are now ready to run the process. Like all good process simulator users (that's you!), please save the process first.

Now run the process.

You may not see much going on. What we need to review is the following:

- pH of the **Neutralized Liq** stream
- The flowrate of the **Adjusted Caustic** stream.

We can do this via the report feature we looked at previously, but we can get quick information directly on the PFD instead. We use a tool called "Callouts."

Right-click the stream **Neutralized Liq**.

Select **Add Callout**.

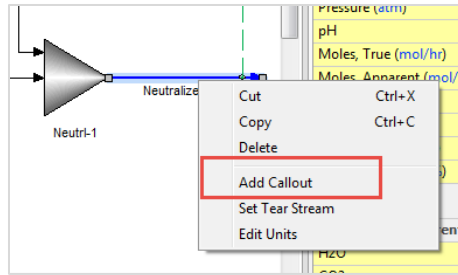

Right-click to add Callout

A callout is displayed on the PFD (if it seems to have moved partially off screen you can grab it and drag it to where you can see it)

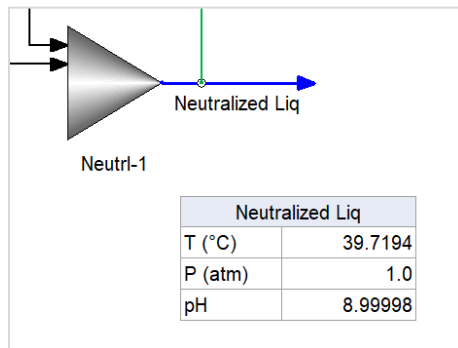

Callout for the stream "Neutralized Liq"

You can see that the pH is nearly 9.0. The reason it is not exactly 9.0 is because there is a tolerance in the controller algorithm. This will be explained in later chapters.

Right-click on the **Adjusted Caustic** stream and add the callout.

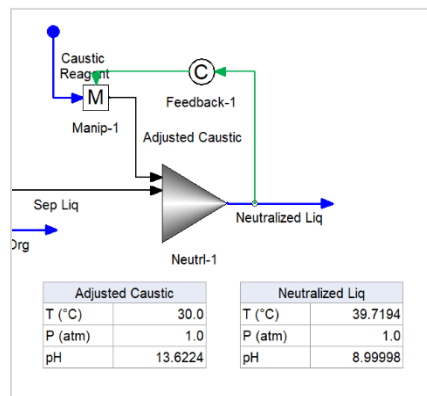

Adding the "Adjusted Caustic" callout

We have dragged the **Adjusted Caustic** callout to where we can view it. Unfortunately, it does not contain the flowrate information we require. Fortunately, we can edit the callout to add the

information. Right-click the **Adjusted Caustic** callout box.

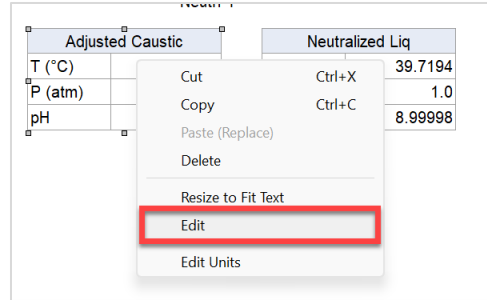

This will display the **Select Variables** dialog. Users of the OLI Studio program will be familiar with this dialog.

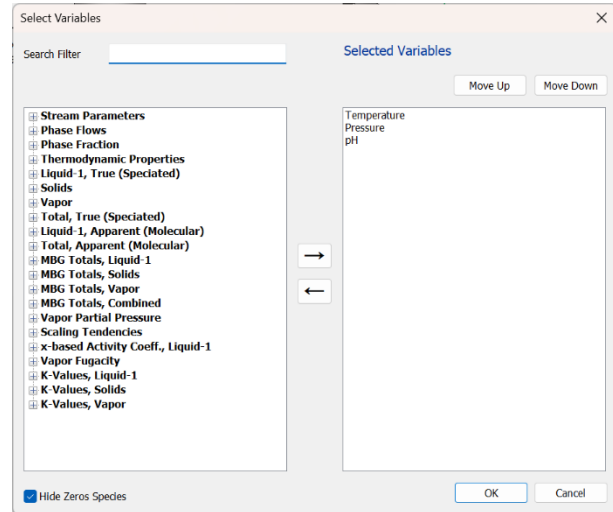

Expand the tree under **Stream Parameters**

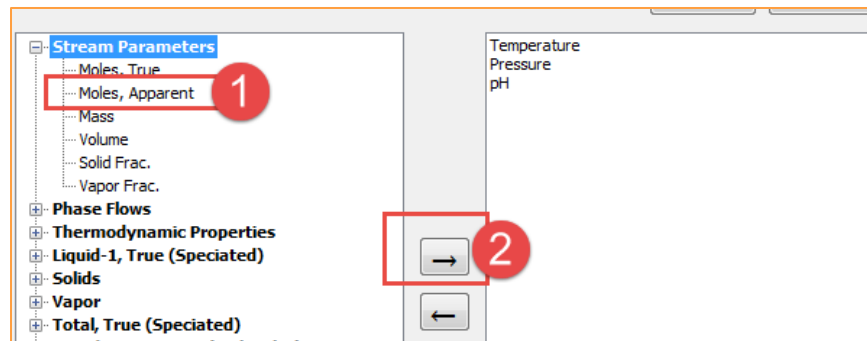

First select **Moles, Apparent** and then Second, click the right-arrow to select it (or just double-click the first option).

This updates the selected variables.

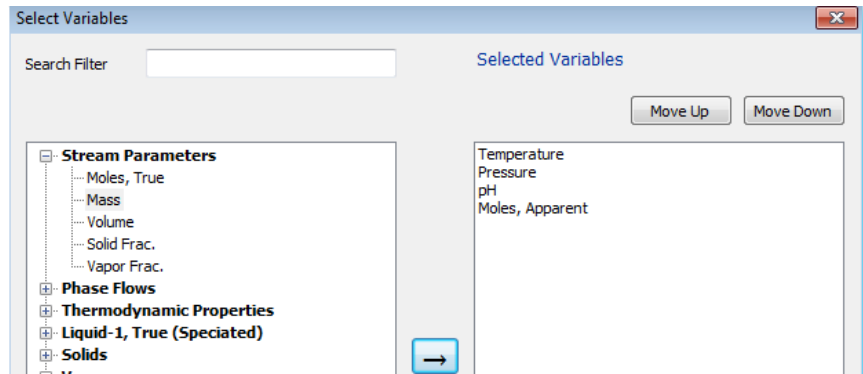

Click **OK** to close the dialog.

The callout on the PFD is updated with the newly selected variables.

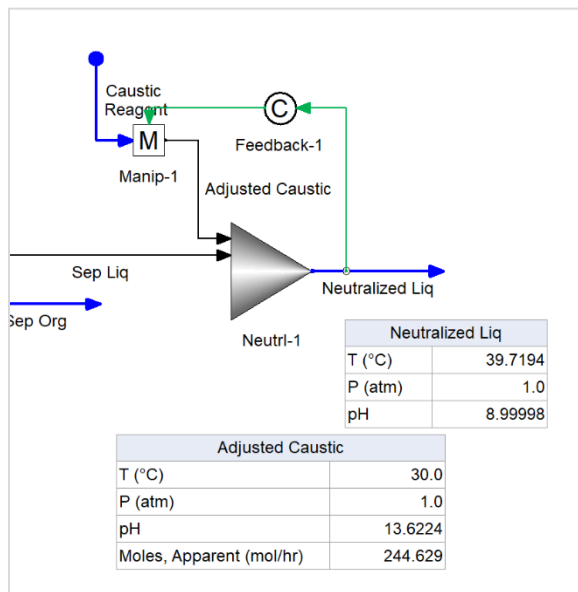

You can see that the flowrate is 244.6 mol/hr for the adjusted caustic reagent stream. Compare this to the value previously found in page 32.

Please save your file.

A tour of OLI Flowsheet: ESP – More Advanced Options

We have just seen that a control block, combined with mixer blocks and manipulate blocks, can be used to control the pH of a stream. Frequently, a process recycles part or all of certain streams back to upstream units. There are many reasons for this, including minimization of waste, increase of residence time, and purification of product.

This application extends the previous application by adding a new mix block, a split block, and a recycle stream. We will be adding sodium chloride (salt) to the process to remove some solids from the solution. We will then recycle some of those solids back to an upstream unit to see the effect, if any, on the amount of caustic required to adjust the pH.

We will be reusing the previous process **Neutral 1 – pH controller**³. Please load this file (if not already loaded), and then let's save the file with a new name. OLI recommends **Neutral 1 – recycle**.

The figure below shows the layout of the new process.

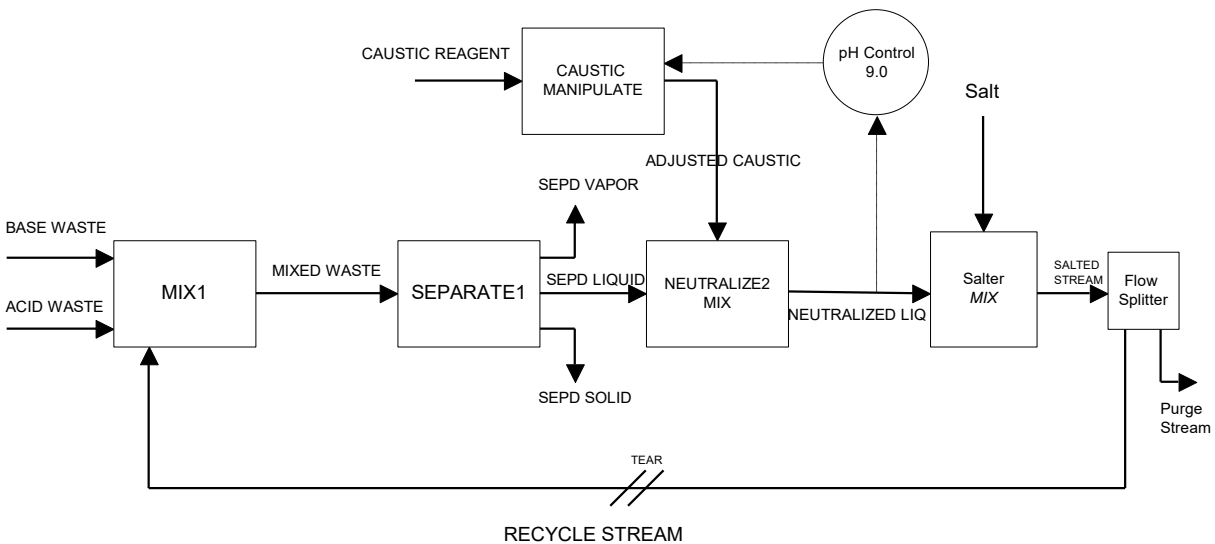

Neutralization Process with Manipulate/Mix Block, pH Controller, and Recycle Loop.

³Or the name you supplied.

Modifying the chemistry

For this example, we need to add some components to the chemistry model. Click the **Chemistry** tab at the top of the PFD.

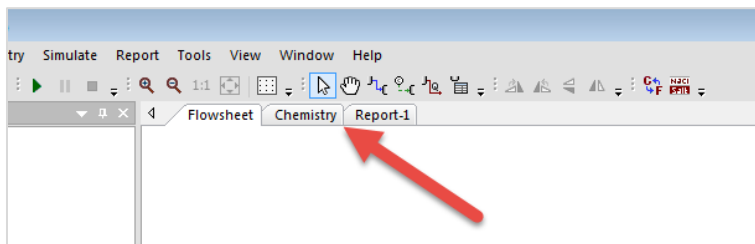

Add the following components to the **Inflows** list:

NaCl
NaHCO₃
Na₂CO₃
Na₂SO₄
(NH₄)₂SO₄

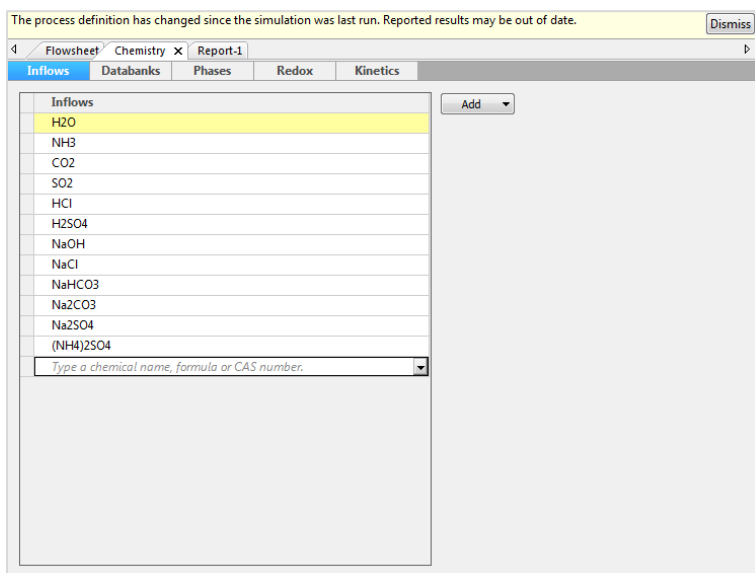

Click **Dismiss** to clear the warning message and then click on the **Flowsheet** tab.

We are going to add a new mixer block and a new stream to the mixer. Please add these two objects to the PFD, and connect them as indicated. The PFD should look like this (the details of the objects will follow):

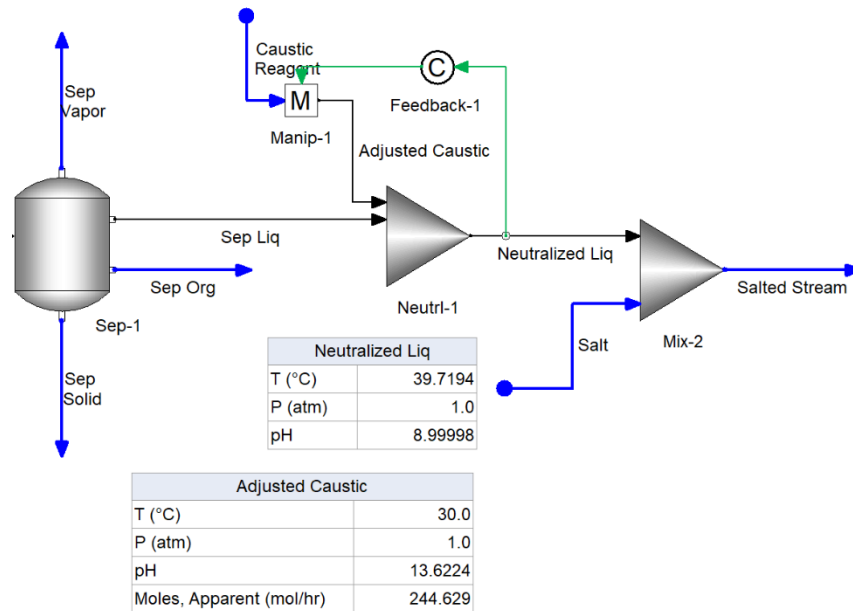

Stream Name	Salt
Temperature, °C	25.0
Pressure, Atm	1.0
Total Flow, mol/hr	75.0
Inflows, mol/hr	
NaCl	75.0
Advanced Options	
Set Phase	Solid Only
Chemistry Model	Chemistry(Default)

There is no water associated with this stream. Under most conditions, we require water as a component. In those cases, where we specifically do not want water in a stream, we must use the option **Set Phase: Solid Only**.

In the table below, you will find the “Salter” Mixer parameters.

Block Type	Mixer
Block Name	Salter
Inlet(s)	Neutralized Liq
	Salt
Outlet(s)	Salted Stream
Equilibrium Calculation	
Calculation Type	Isothermal
Temperature (°C)	40.0
Pressure Spec.	Min. Inlet Pressure
Advanced Options	
Chemistry Model	Chemistry (Default)

We will now split the **Salted Stream** to discharge some of the material and recycle some of the material. We now need to add a flow splitter to the PFD. A flow splitter is named “Splitter” in the library. By now you should be able to find unit operations in the library, so we will not show you an image for this.

Drag the **Splitter** and place it to the right of the **Salted Stream** on the PFD.

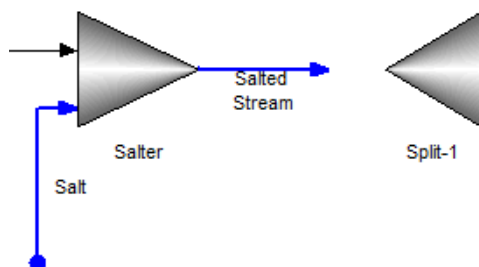

As with other objects, we need to connect the streams. The **Salted Stream** will be connected to the inlet of the **Split-1** block and two outlets will be defined, **Purge** and **Recycle**.

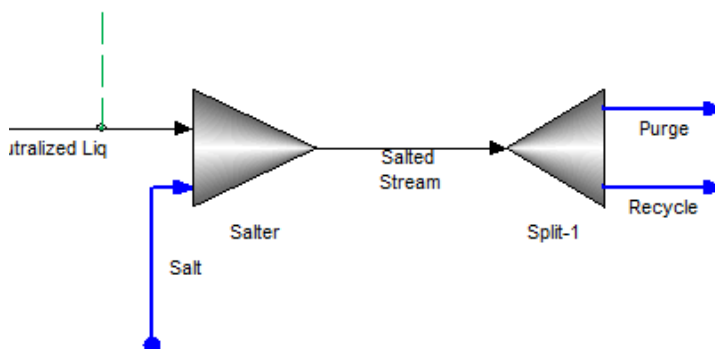

The parameters for the **Split-1** block are found in the table below:

Block	Splitter (flow)
Block Name	Split-1
Inlets(s)	Salted Stream
Outlet(s)	Purge
	Recycle
Parameters	
Outlet Split	Flyout (edit) This launches a new dialog.
Advanced Options	
Chemistry Model	Chemistry (Default)

Enter the fractions that you want to purge and recycle:

Edit Split

Enter the fraction of each outlet to the total or the flow.
Flows will be removed first from the total. The remaining fractions will be normalized.

Flow Basis: Moles Mass Volume

Outlet	Fraction	Flow (mol/hr)
Purge	0.25	
Recycle	0.75	

Click **OK** to close the dialog.

Right now, the PFD may look skewed or shifted to the right. We can zoom and center the diagram with a tool in the toolbar.

Click the **Zoom to Fit** tool button.

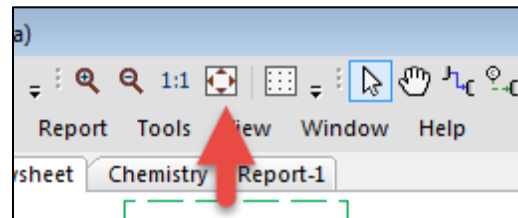

Zoom to Fit tool

We now need to connect the **Recycle** stream back to the upstream block **Mix-1**.

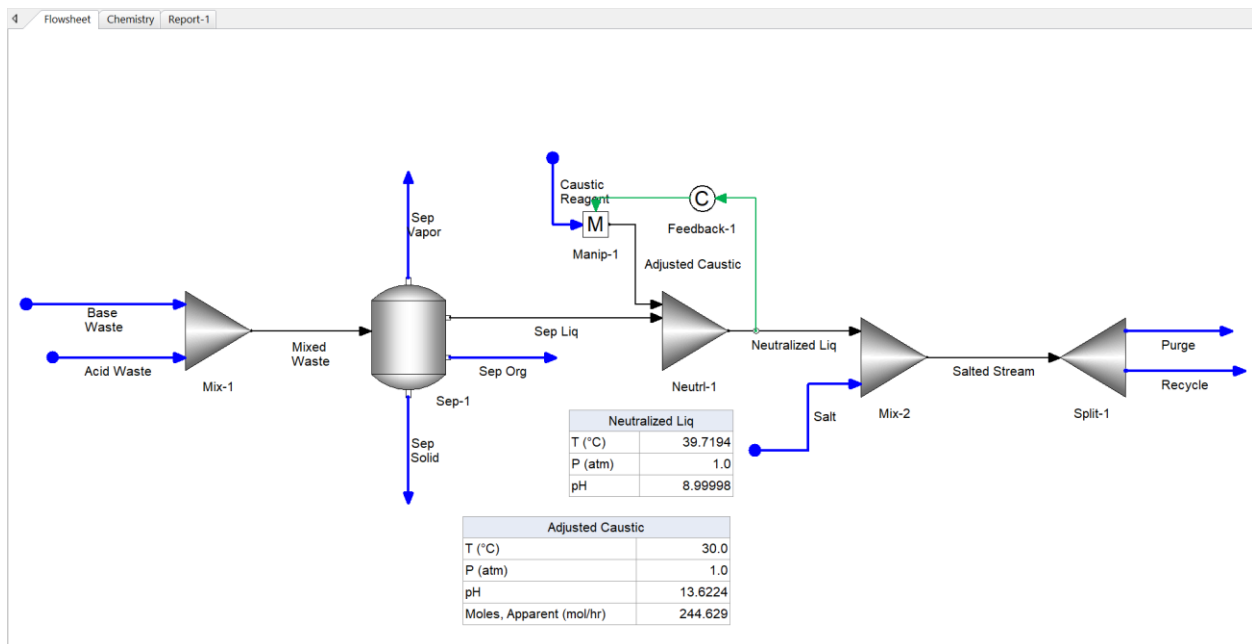

The PFD should look that the image below:

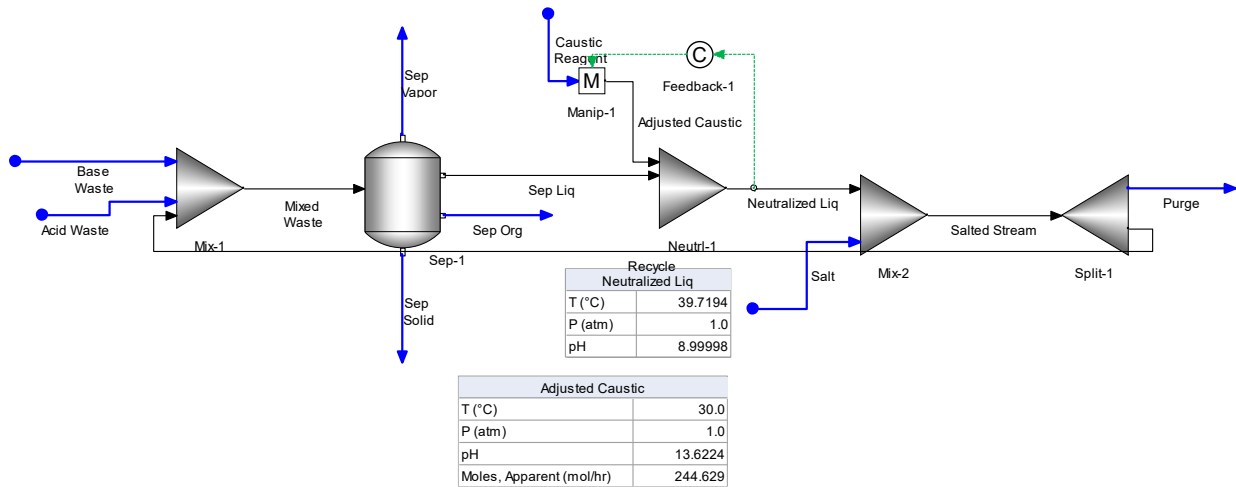

This is a bit messy to read. We can drag our **Recycle** stream down to the PFD is easier to read. Click the stream and find one of the “Anchors” and drag the stream down.

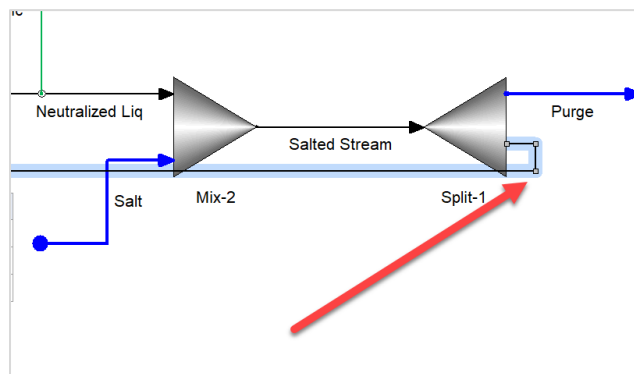

Finding the "Anchor"

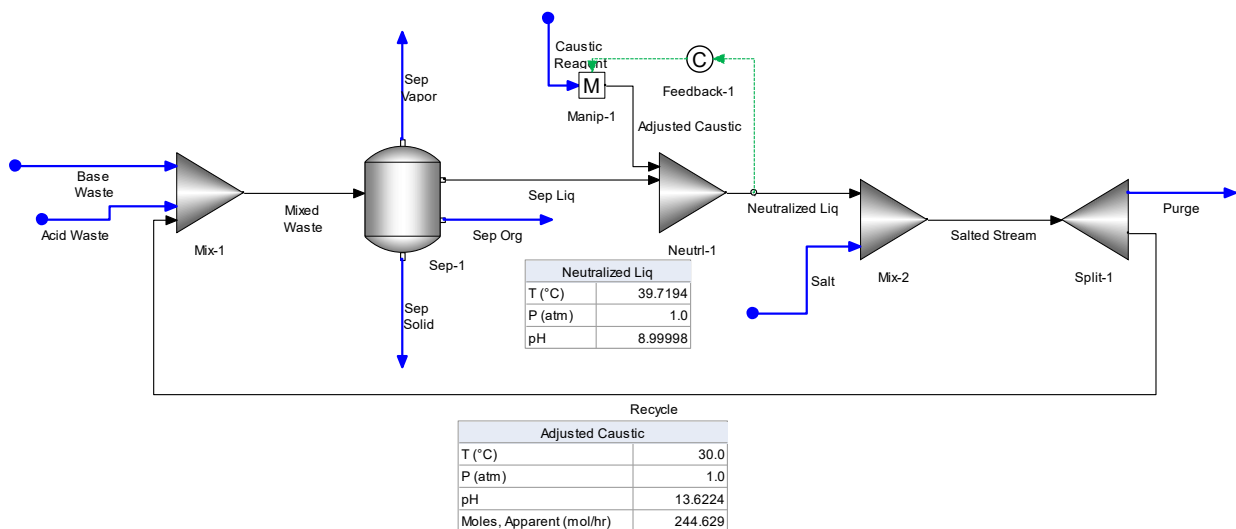

This PFD is certainly easier to read than the previous image.

Processes with recycle streams require some additional information to be provided prior to running the simulation. In processes without a recycle stream, the order of block calculation is easy to determine. Generally, the first block defined is the first block that is calculated.

In recycle processes, we must tell the program where to begin calculating. We do this by defining a process stream as a *TEAR* stream. Tear streams are treated as normal process entry streams and require an initial composition. These compositions should be representative of the process, and some care should be taken in specifying the stream.

In this example, the stream **Recycle** is a likely candidate for a **TEAR** stream. Right-click the stream **Recycle**.

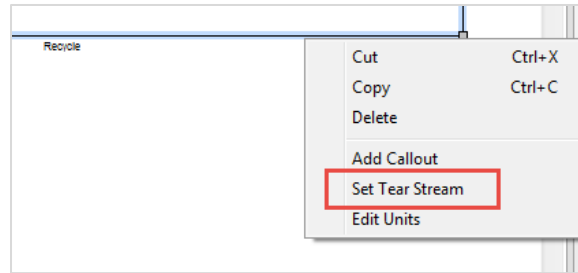

Setting a TEAR stream

When you select a **TEAR** stream, you get the opportunity to specify an initial guess. The OLI Flowsheet: ESP program updates with a new stream definition when the **TEAR** stream is highlighted.

The screenshot shows a process flow diagram with several units: Mix-1, Sep-1, Manip-1, Neutri-1, Mix-2, and Split-1. A recycle stream labeled 'Recycle' is shown with a double-hash mark (//). The Properties window for the 'Recycle' stream is open, showing the 'Definition' tab with the following data:

Parameters - Initial Guess	
Temperature (°C)	40.0
Pressure (atm)	1.0
Total Flow (mol/hr)	504.015
Inflows - Initial Guess (mol/hr)	
H2O	391.518
NH3	2.64504
CO2	0.0943862
SO2	0.253517
HCl	48.0199
H2SO4	0.0
NaOH	51.0679
NaCl	8.42884
NaHCO3	0.0
Na2CO3	0.0
Na2SO4	0.0
(NH4)2SO4	0.0
SO3	1.98728
Total	504.015

Entering the initial guess for the TEAR stream

Notice that the **TEAR** stream is indicated with a double-hash mark (“//”)

Enter the following initial values for the **TEAR** stream (note that some values were skipped in the input):

<i>TEAR Stream Initial Guess</i>	Recycle
Temperature, °C	40.0
Pressure, atm	1.0
Total Flow, mol/hr	213.19
Inflows, mol/hr	
H2O	186.74
NH3	0.331
CO2	0.002
HCl	0.0006
NaCl	25.1
NaHCO3	0.005
Na2CO3	0.023
Na2SO4	0.46
(NH4)2SO4	0.42

Process simulations with **TEAR** streams may take a long time to converge. We can monitor the approach to convergence with a tool called the **Convergence Monitor**. You enable the **Convergence Monitor** via the **Menu > View > Windows and Toolbars > Convergence Monitor**.

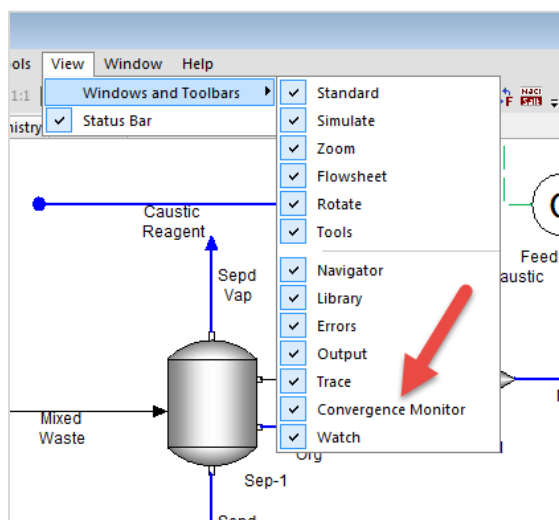

Enabling the convergence monitor

This creates a new panel in the program. The new panel appears below the PFD.

The screenshot shows a software interface for a process flow diagram (PFD). The main window displays a process flow with several units: Mix-1, Sep-1, Manip-1, Neutral-1, Mix-2, and Split-1. A recycle loop is present, involving 'Adjusted Caustic' and 'Neutralized Liq'. The 'Adjusted Caustic' stream is recycled from the output of Manip-1 back to its input. The 'Neutralized Liq' stream is recycled from the output of Neutral-1 back to its input. The process starts with 'Acid Waste' and 'Mixed Waste' entering Mix-1. The output of Mix-1 goes to Sep-1, which separates 'Sep Vapor' and 'Sep Solid' from 'Sep Liq'. The 'Sep Liq' goes to Manip-1, which adds 'Caustic Reagent' and produces 'Adjusted Caustic'. The 'Adjusted Caustic' is recycled. The 'Sep Liq' also goes to Neutral-1, which produces 'Neutralized Liq' and 'Salt'. The 'Neutralized Liq' is recycled. The 'Salt' goes to Mix-2, which also receives 'Purge' from Split-1. The output of Mix-2 goes to Split-1, which separates 'Purge' from 'Salted Stream'. The 'Salted Stream' goes to Purge. The 'Properties' panel on the right shows 'Process Options' with various settings. The 'Convergence Monitor' at the bottom shows a plot of 'Error/Tolerance' vs 'Number of Iterations'.

Simulation Paused

Save the file and then run the process.

Unlike the previous tours, this tour will recalculate many of the blocks as the program attempts to converge the recycle stream, or in other words, to make the values in the recycle loop consistent between successive iterations. This may take several iterations to complete.

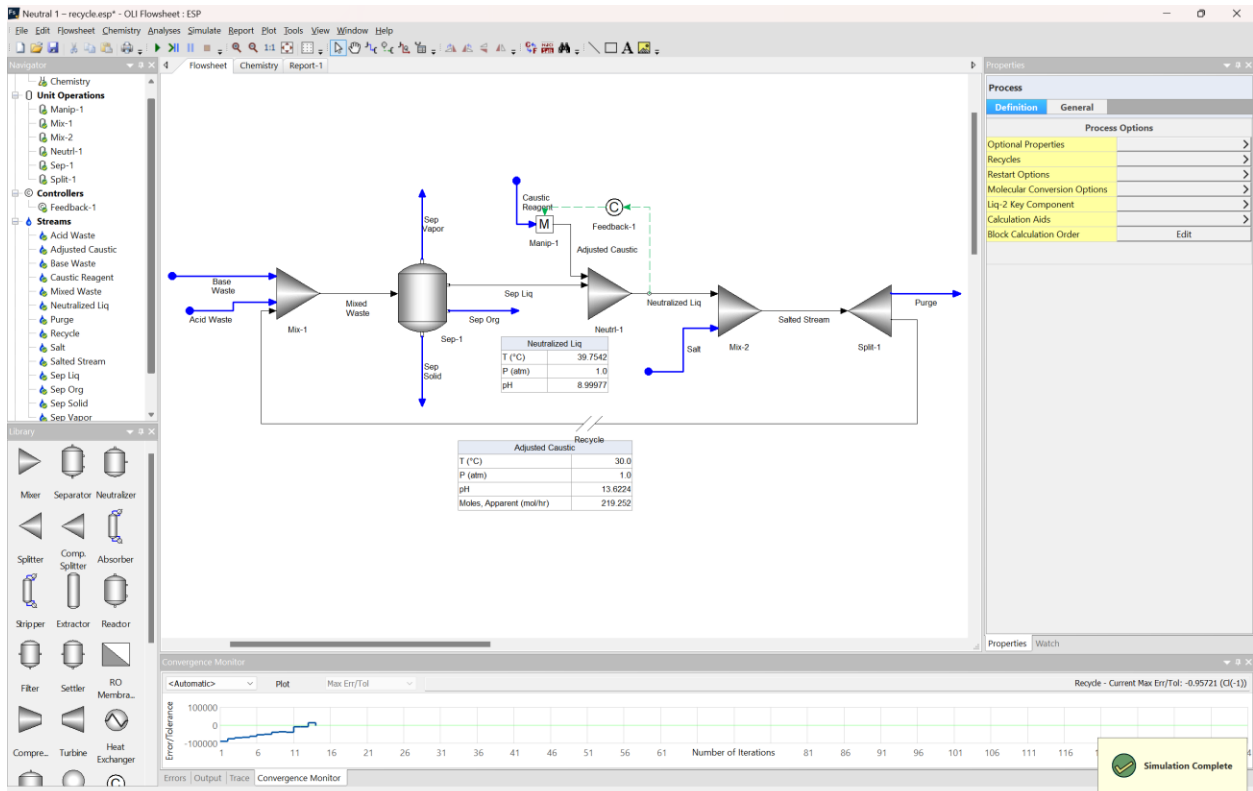

The case has converged. The convergence monitor has shown the state of the convergence of the **TEAR** stream over approximately 14 iterations. We will explain this convergence in later chapters.

What has happened in this process? We left the callouts from the previous tour in place. You can see that the pH of the neutralized stream is 9.0 which is what we required. The amount of the **Adjusted Caustic** stream is approximately 219 mol/hr which is less than the 244 mol/hr we found in the example without the recycle stream. This means some of the unreacted caustic stream was used to neutralize the solution.

You can explore many other options and reports, and we encourage you to do so. These worked examples will be on the [OLI Support Center](https://support.olisystems.com/hc/en-us/articles/33851387838995-Introduction-to-OLI-Flowsheet-ESP-for-First-Time-Users) page in the following link:

<https://support.olisystems.com/hc/en-us/articles/33851387838995-Introduction-to-OLI-Flowsheet-ESP-for-First-Time-Users>

Please save your file.

Chapter II – Process Options

Overview

The OLI Flowsheet: ESP screen is roughly divided into 6 sections.

1. The top section is Menu Items and Toolbar
2. The leftmost section is the Navigator Panel. The navigator panel will have the tree of all the objects in the current flowsheet.
3. The middle section is the Flowsheet window. This view can be switched by the tabs at the top to Chemistry view or Report view
4. The Properties Pane has two tabs: properties variables and watch variables.
5. The bottom section has four tabs: Errors, Output, Trace, and Convergence Monitor
6. The bottom left corner is the Library; it has all the unit operation blocks.

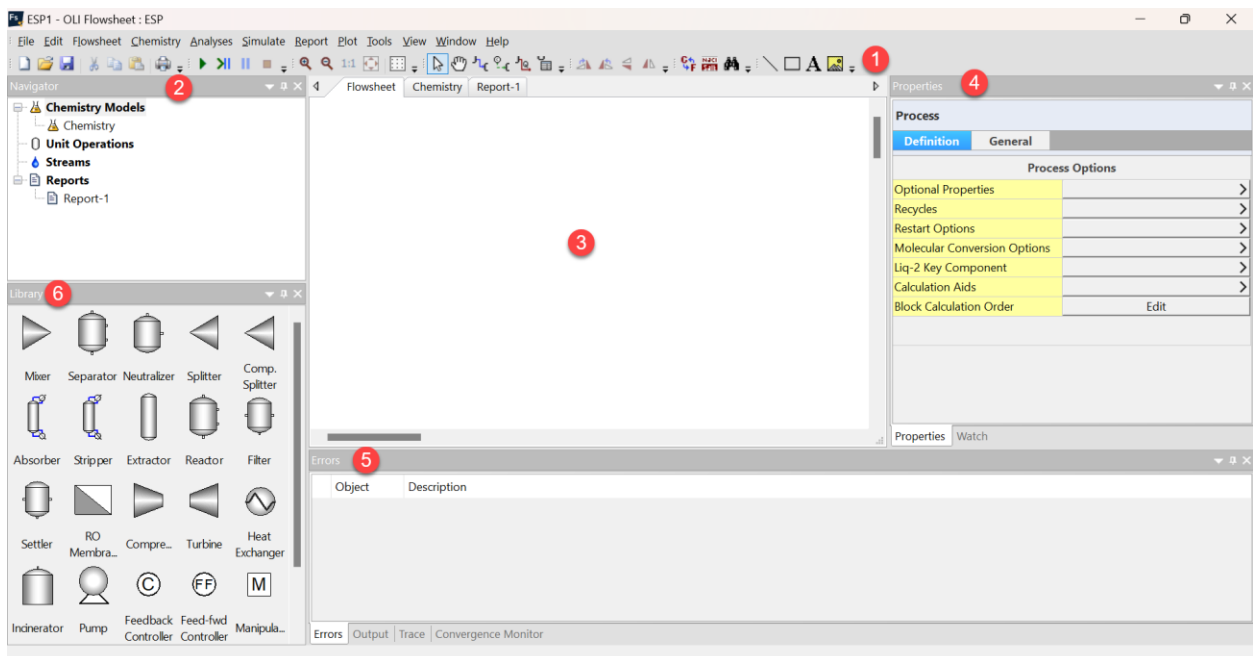

Menu Items

The following image shows the menu items:

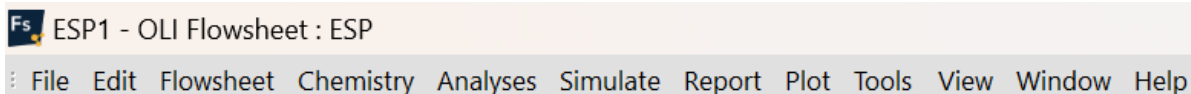

File

The options under File are as follows:

- *Ctrl+N* shortcut or the New file icon will open a new file.
- *Ctrl+O* shortcut or the Open file icon will open an existing file.
- *Close* will close the file.
- *Ctrl+S* shortcut or Save icon will save the file.
- *Export* options: exports the .bin file and associated file types from a OLI Flowsheet: ESP type file. The .bin file is compatible with the ESP Original program
- *Upload to OLI Cloud...* will upload the current file to the OLI App Builder account associated with the user
- *Case Library...* allows access to OLI's repository of sample simulation files from multiple industries
- *Examples...* option has sample files created for the OLI Flowsheet: ESP program.
- *Ctrl+P* shortcut or Print option will print the Flowsheet section
- Below print, recently opened files are automatically pinned
- *Exit* will exit the F: ESP program.

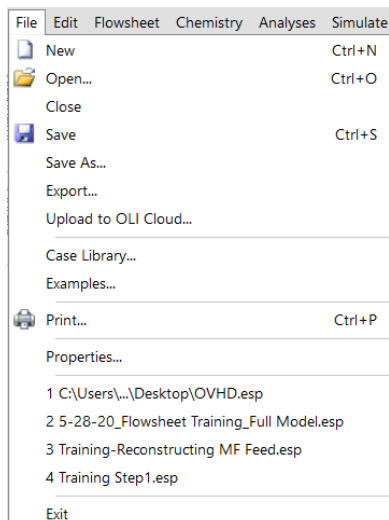

Edit

The options under Edit are as follows:

- *Ctrl+Z* shortcut or Undo will undo the latest action in the Flowsheet, Chemistry, or Report section.
- *Ctrl+Y* shortcut or Redo will redo the latest action in any of the above three sections
- Cut will cut an object (*Ctrl+X*)
- Copy will copy the object (*Ctrl+C*)
- Paste will paste the object (*Ctrl+V*)
- Delete will delete the object
- Select All will select all the objects (*Ctrl+A*)

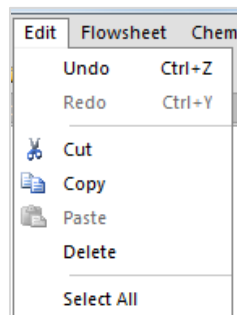

Flowsheet

The options under Flowsheet are as follows:

- Add Block: Will add a selected Block
- Add Stream: Will add a Stream
- Add Control Connection: Will add a Control Connection
- Add Energy Connection: Will add an Energy Connection
- Add Callout: Will add a callout with information about the stream
- Zoom 100%: Ctrl+0 is a shortcut for a 100% zoom
- Zoom to Fit: This option will fit the flowsheet to the screen
- Show Grid: You can change the display options on the flowsheet screen and use a grid as a background
- Snap to Grid: Snaps the objects back to the grid
- Show Page Bounds: You can see the limits of the page
- Highlight Currently Paused Block: Shows in the simulation the last converged block when using the step through calculation run button
- Changed Selected Block's Icon: Once selected, a block may have different icons available for the user to choose from and more closely resemble their process
- Save as Picture: This tool is useful to print the flowsheet.

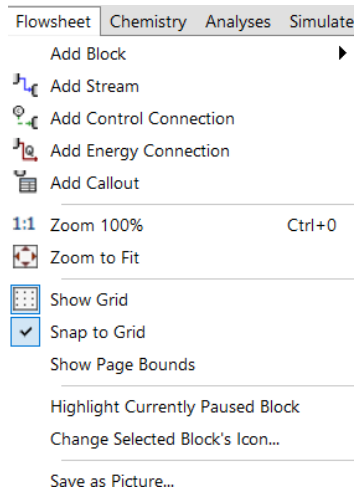

Chemistry

The options under Chemistry are as follows:

- Add Pseudo-Component
- Add Assay
- Add New Chemistry Model.

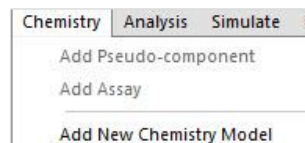

Analysis

The options under Analysis are as follows:

- Sensitivity Analysis
- Water Analysis
- Optimizer

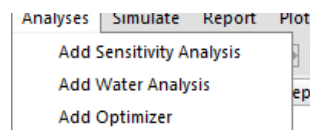

Simulate

The options under Simulate are as follows:

- Run (F9)
- Pause
- Stop
- Clear Results

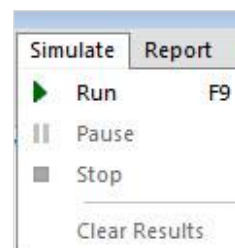

Report

The options under Report are as follows:

- Add Stream Report
- Add Block Report
- Add Multi-stream Report
- Add Overall Process Balance Report
- Add Water Analysis Report
- Customize
- Export

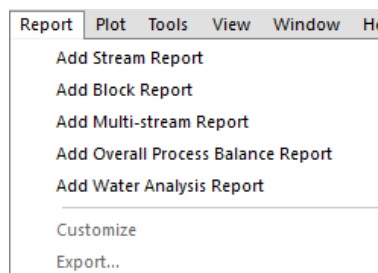

Plot

The options under Plot are as follows:

- Add Sensitivity Plot
- Show Data Grid
- Select Data
- Add Block Report
- Export



Tools

The options under Tools are as follows:

- Edit Units
- Component Name Style
- Component Search
- Diagnostics
 - View Model (mod) File
 - View Gen. Model (dbs) File
 - View Input (bin) File
 - View Results (bst) File
 - View Output (bou) File
 - View Trace (oue) File
 - View Model Warnings (wrn) File
 - View Databank Summary (loc) File
 - View Interaction Matrix (csv) File
- Options

The sub-options under Diagnostics are as follows:

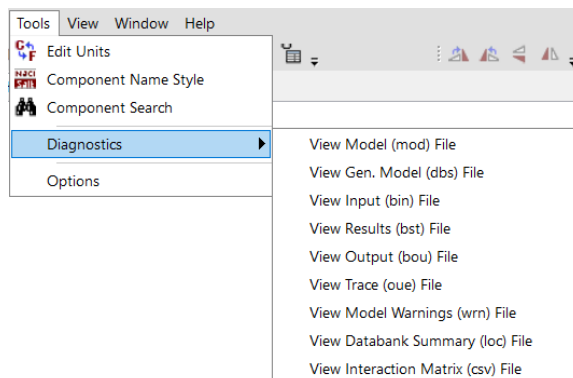

View

The options under View are as follows:

- Windows and Toolbars
 - Standard
 - Simulate
 - Zoom
 - Flowsheet
 - Rotate
 - Tools
 - Annotation
 - Navigator
- Status Bar
 - Library
 - Errors
 - Output
 - Trace
 - Convergence Monitor
 - Watch
 - Reset Layout...

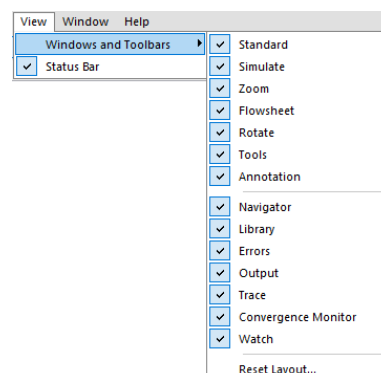

Window

The options under Window are the last file name(s) that had been opened.



Help

The options under Help are as follows:

- Getting Started
- User Guide
- Support Center...
- About OLI Flowsheet: ESP

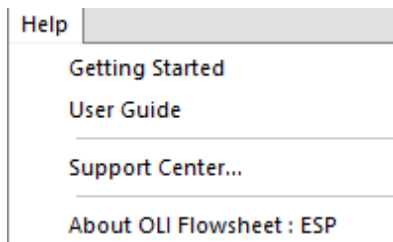

Toolbar

The top toolbar for OLI Flowsheet: ESP:

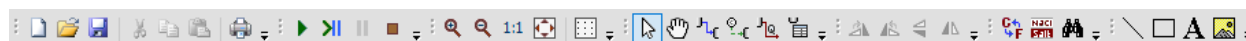

The toolbar is divided into seven sections.

1. File Management

This section has file options:

- New
- Open
- Save
- Cut
- Copy
- Paste
- Print



2. Simulation or execution options

This section has execution options:

- Run
- Step
- Pause
- Stop



3. View options

This section controls the Grid and View options.

- Zoom in
- Zoom out
- Resize
- Pan
- Center
- Grid



4. Design Control Options

- Mouse Pointer
- Pan
- Add a Stream
- Add a Control Connection
- Add an Energy Connection
- Add a Callout

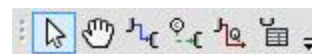

5. Rotation Controls

- Rotate 90° to the right
- Rotate 90° to the left
- Flip Vertical
- Flip Horizontal



6. Managers

- Units Manager
- Names Manager
- Component Search



7. Drawing Tools

- Insert a line
- Insert a rectangle
- Insert text
- Insert image

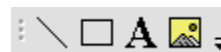

Adding callouts

Callouts are extremely useful in describing what your process is doing right on the PFD. You can always get detailed information using the reports, but sometimes a quick glance is all you need.

There are two methods to place a callout on the PFD. The easiest is to right-click on the stream/UnitOp block of interest and select **Add Callout**. In this example, we have a process to which we wish to add a callout:

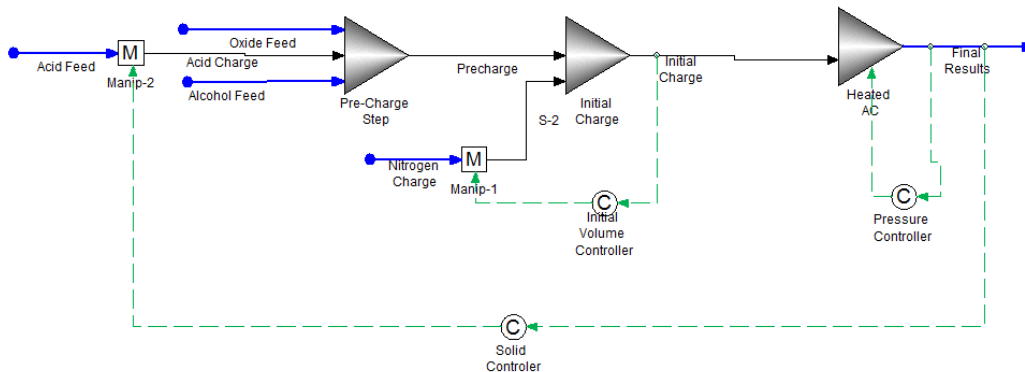

This actual process is a simulation of an autoclave. Frequently, we need to know the volumetric flow of a stream. In this example, we will right-click the stream **Initial Charge** and then select **Add Callout**.

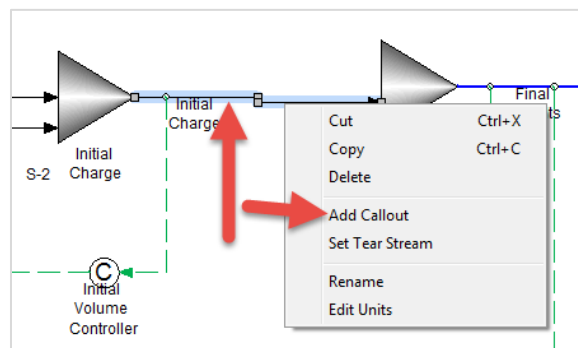

Adding a callout

Sometimes OLI Flowsheet: ESP doesn't put objects in convenient places, as is shown below:

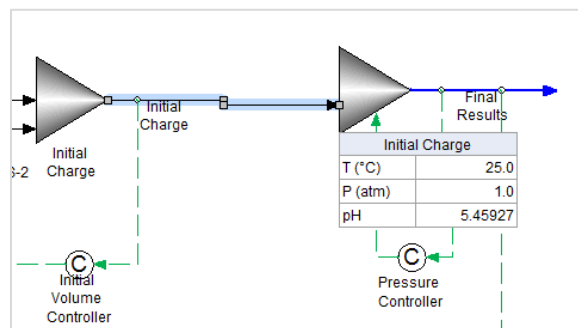

If you click the callout, you can move it to a more readable location:

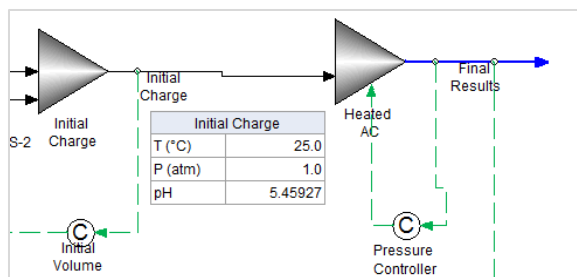

Editing a callout

The default values for any callout are Temperature, Pressure, and pH. We are interested in these, but what we really need to know is the total volumetric flow. Right-click the callout and select **Edit**.

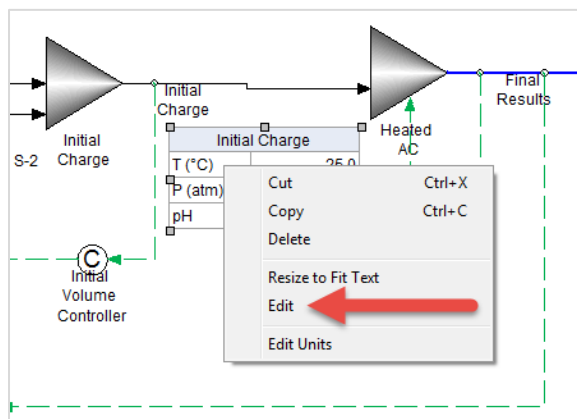

Editing a callout

This will display a Select Variables dialog that is very much like the Select Variables dialog in OLI Studio.

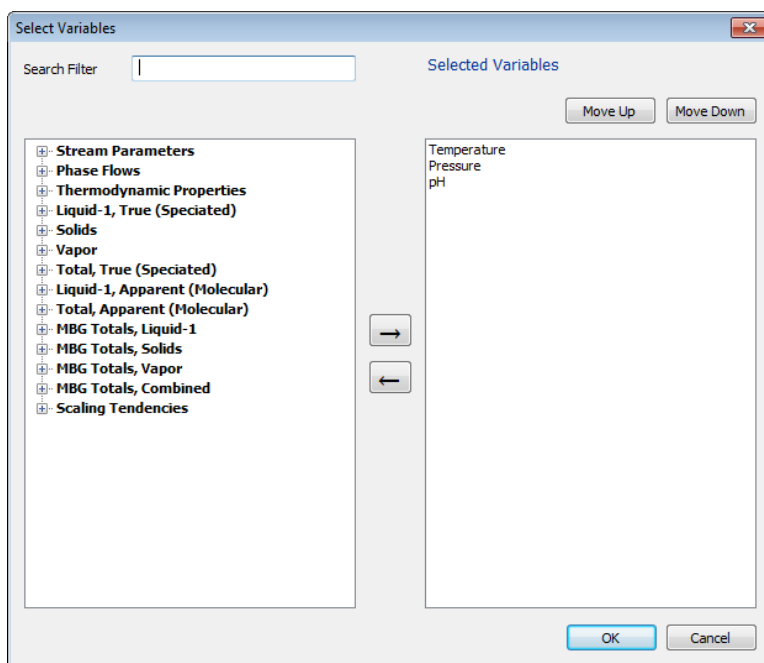

Expand the **Phase Flows** category and locate the variable **Volume**:

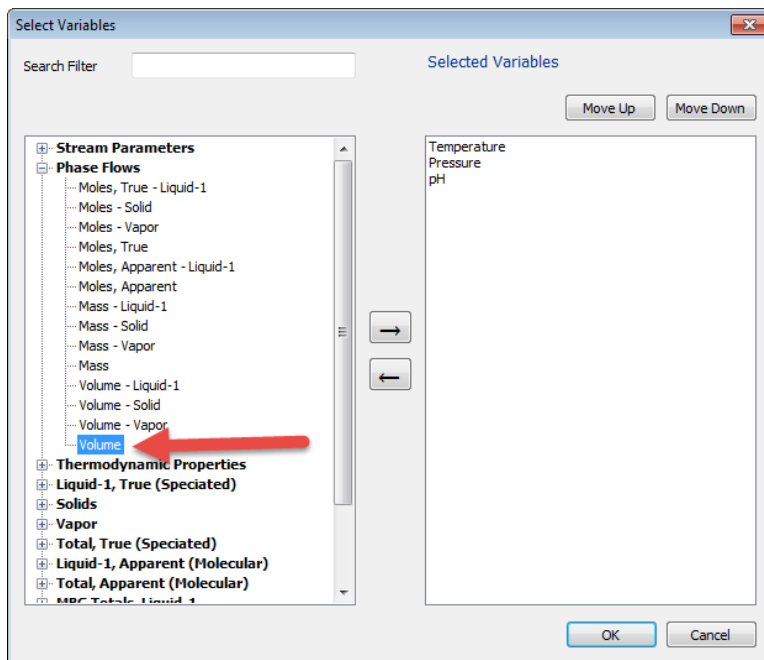

This variable is the sum of the volumes for all phases. Click the right-arrow key to select it.

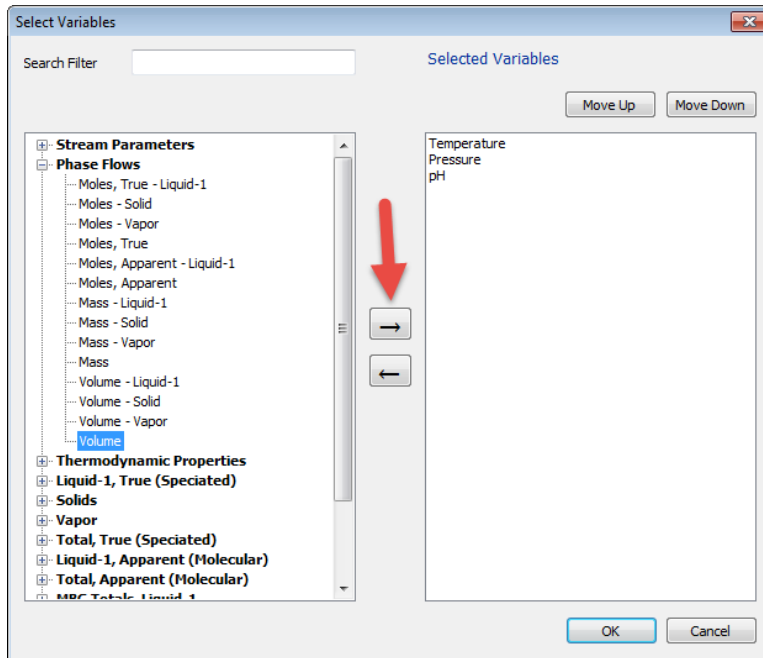

Using the right arrow key (you could also double-click the variable to select it)

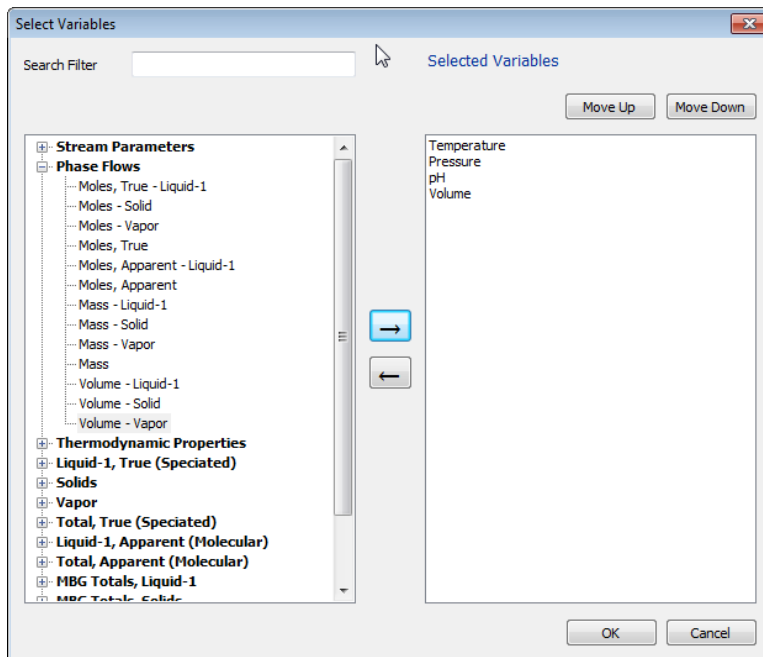

Click the **OK** button to continue.

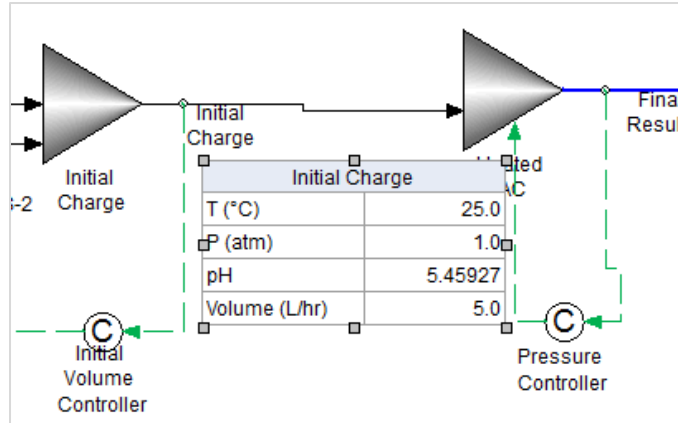

The alternative method to add a callout is to use the menu bar. For this example, we are going to select the stream **Final Results**.

Locate the Callout toolbar button:



The callout toolbar button

When you click this button, the cursor changes shape to a small hand-like object, and a red dotted-lined box appears when you are hovering over an acceptable object, such as a stream or block.

Click to place the box.

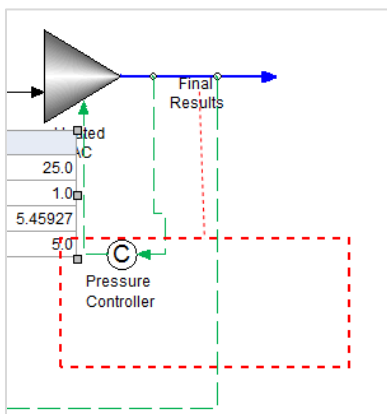

A dotted box appears

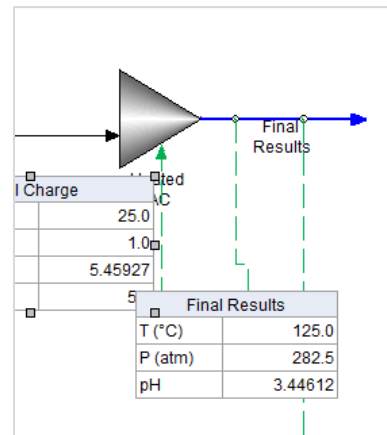

The dotted box has turned into a callout box

Editing the units for a callout

The units manager is similar to the units manager in OLI Studio and elsewhere in OLI Flowsheet: ESP. Once the callout has been placed, you can right-click and select **Edit Units**.

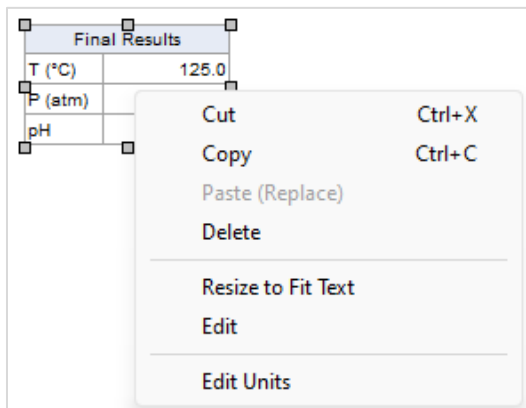

This will bring up the initial Edit Units dialog:

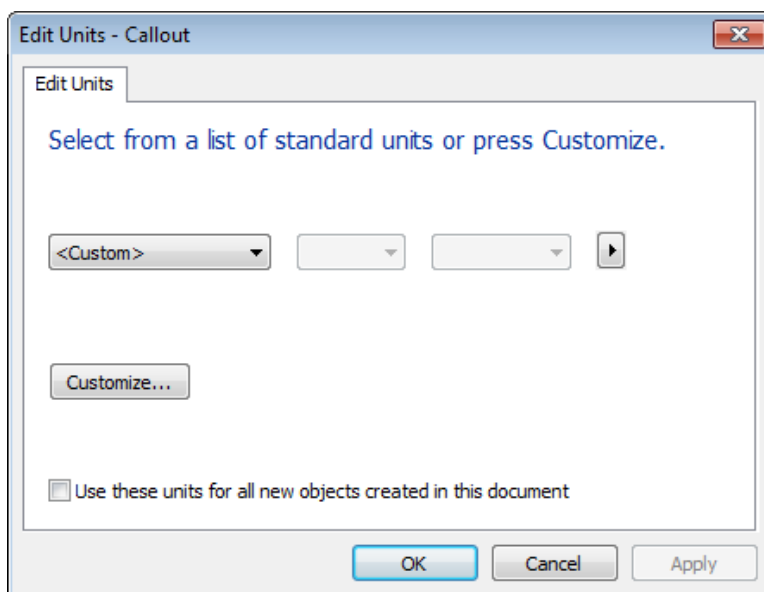

Normally for a callout, we do not need to make global changes. For this example, we are going to change the temperature units from degrees centigrade to Fahrenheit. Click the **Customize** button.

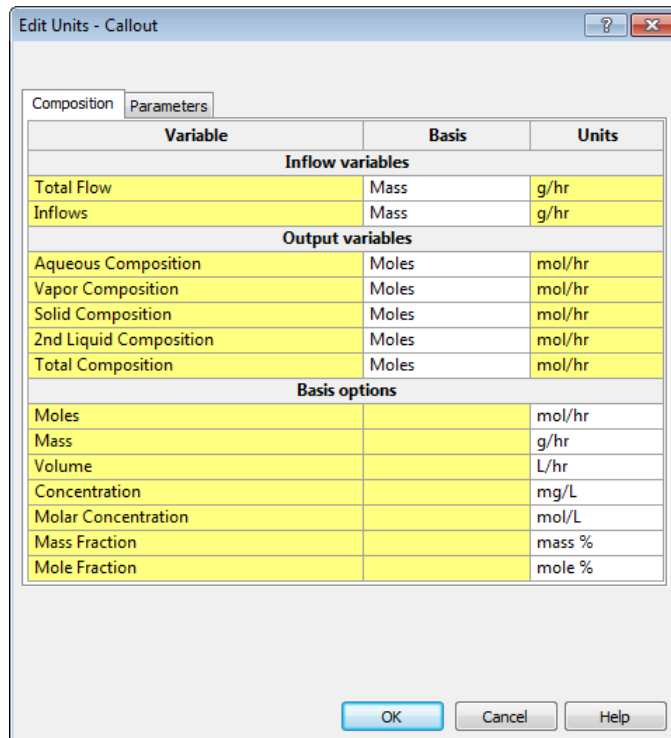

Click the **Parameters** mini-tab.

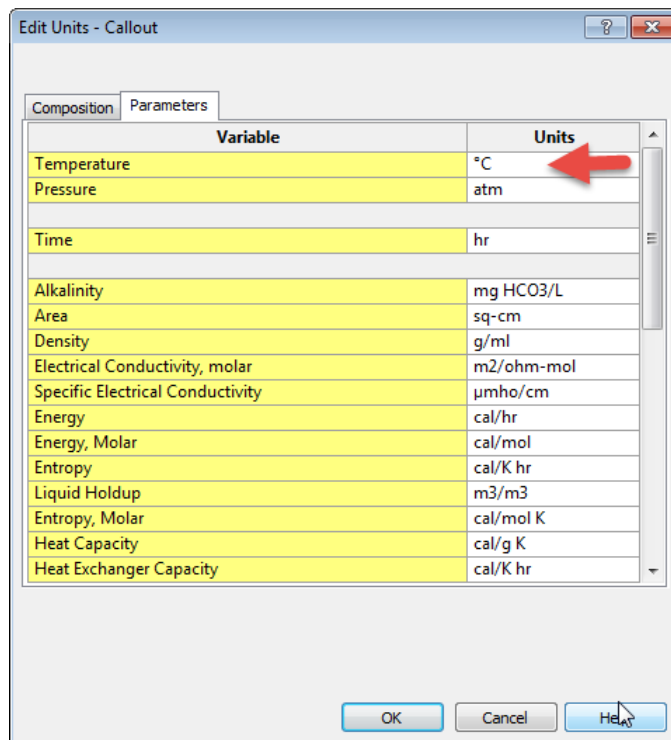

If you click in the box where you wish to change the unit, a drop-down menu will appear:

Variable	Units
Temperature	°C
Pressure	°C
	K
Time	°F
	R

You can select the desired unit. You will need to click the **OK** button several times to return to the PFD.

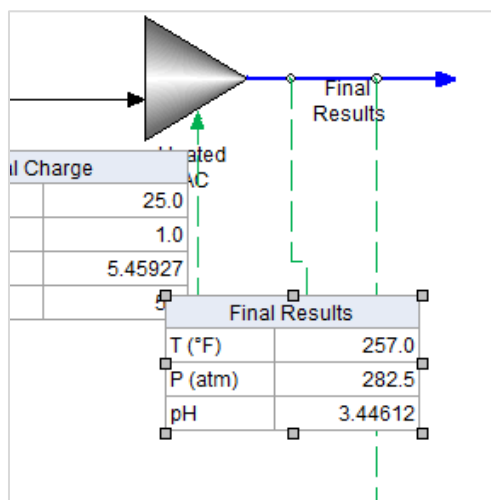

Copy and paste a callout

Once you are satisfied with the parameters and units that you want to show in your callout, you can easily copy and paste them into a different stream where you want to see the same variables. This reduces the time to make customized callouts for different streams.

To do this, select the callout that you want to replicate, right-click, and select copy.

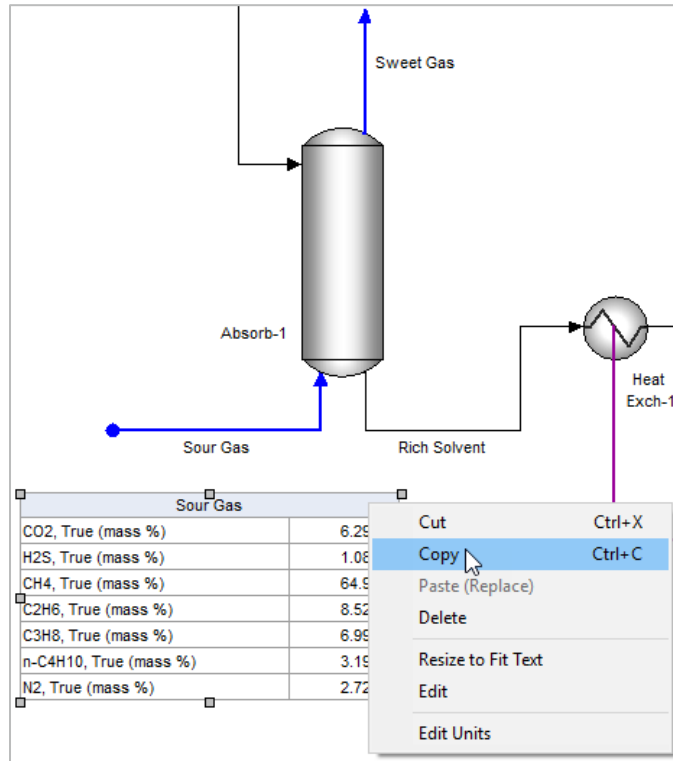

Then, select the stream where you want to place the callout, and select Paste Callout.

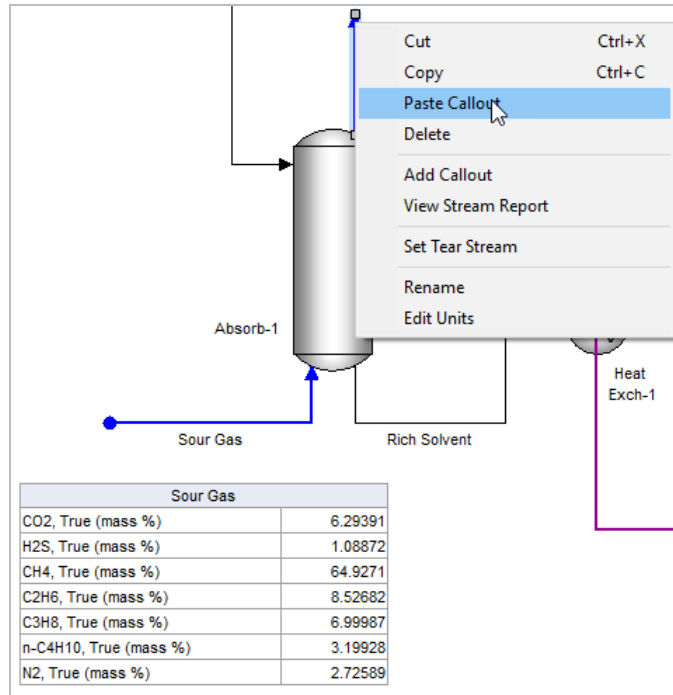

The same information and units have been transferred to a different stream.

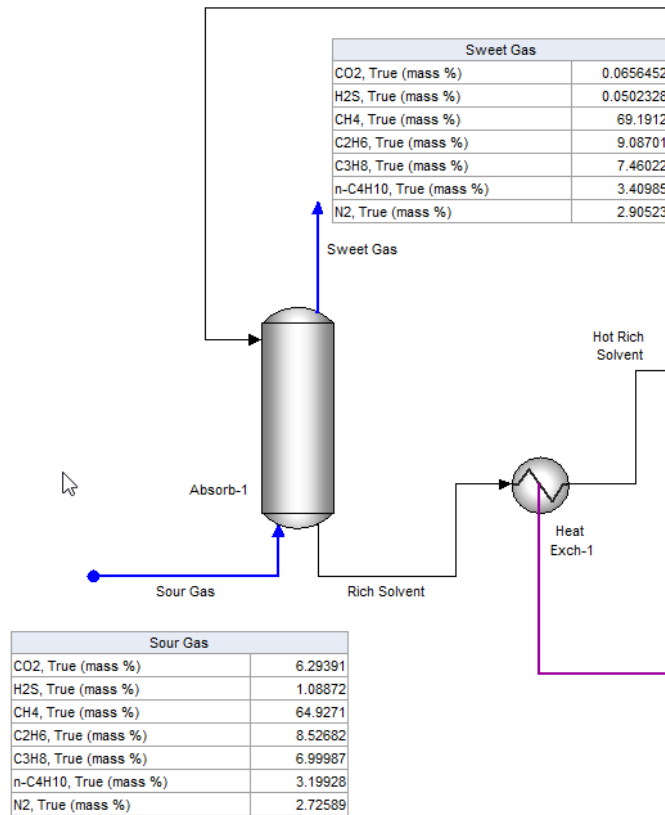

Process Options

The Properties Panel has two tabs. The Definition tab has seven process options. The General tab contains the information specified by the user about the name of the application being built. It also has a “Notes” section where the user can input any notes for the simulation

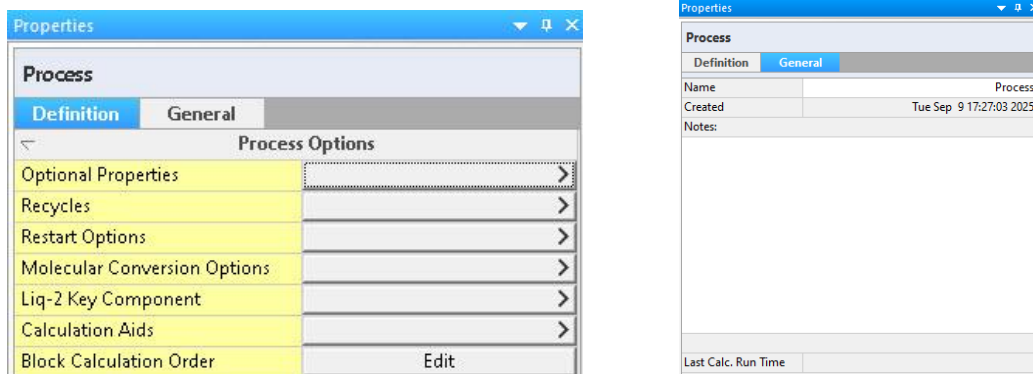

Optional Properties

This section has the optional properties that can be calculated while running the simulation. The screen lets users choose from an option of a drop-down if they want to enable or disable the calculation of that property. There is also the option to add a new property and define it. The following is the list of available properties.

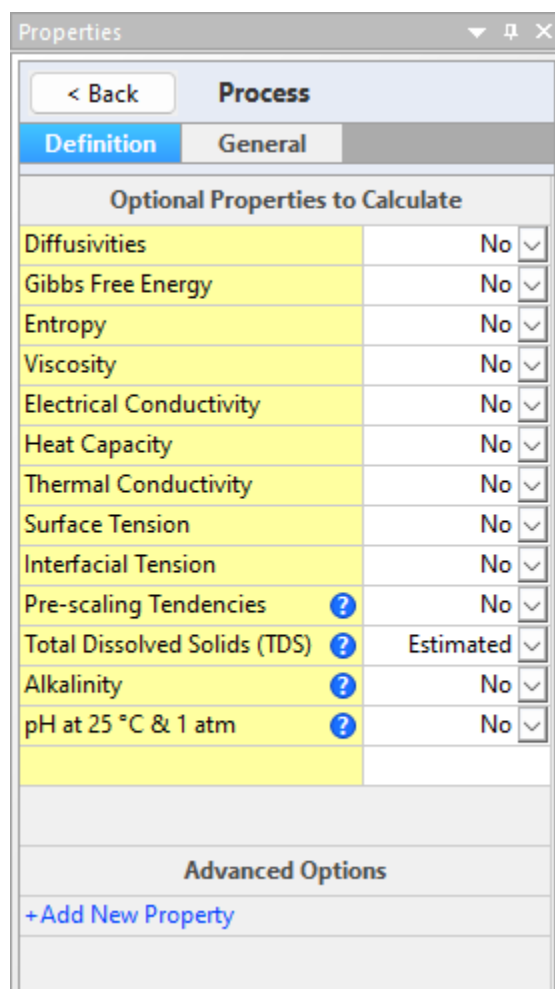

To enable the calculation of any of the properties, click on the drop-down arrow and select **Yes**.

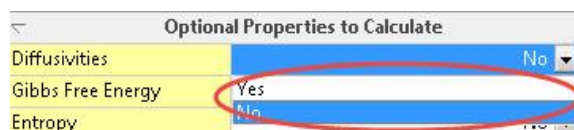

The user also has the ability to define their own custom property they want calculated by pressing the **+Add New Property** button.

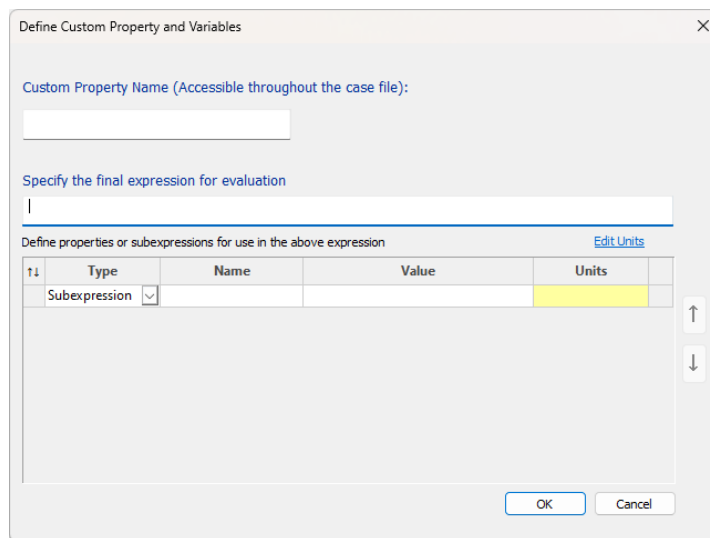
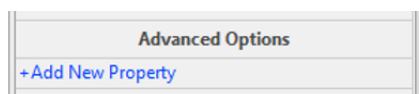

Recycles

When this facility is selected, an analysis of process recycle streams is performed automatically. If a recycle exists, the user can then choose from several options to define the tear stream and recycle convergence.

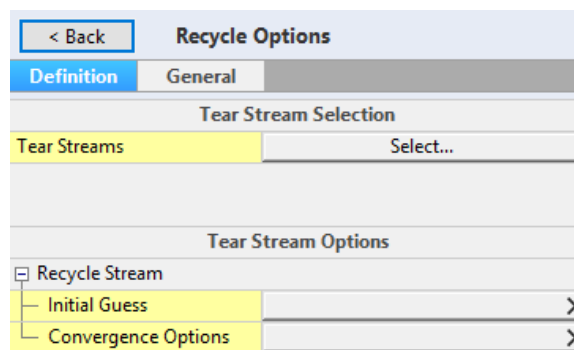

Tear Stream: When clicking **Select** in the Tear Stream recycle options, a new window will open.

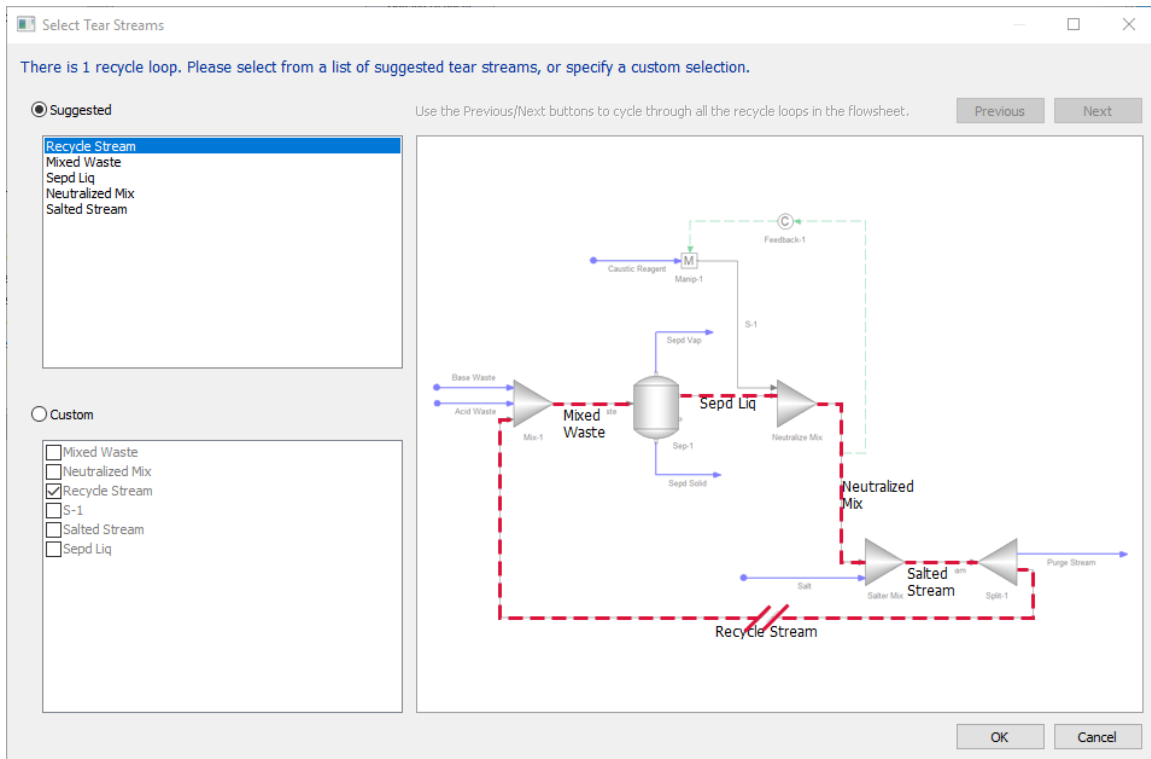

In the previous window, a suggested tear stream is given; however, the user can specify a custom tear stream.

Convergence options that can be specified after selecting a tear stream and are as follows:

Recycle Stream	
Definition	General
Convergence Options	
Convergence Method	Wegstein
Max. Iterations	Wegstein
Not Converged Rule	Newton Avg. Wegstein
Temperature Tolerance (°C)	0.01
Flow Tolerance	5.0e-5
Wegstein Convergence Parameters	
Theta (Maximum)	5.0
Theta (Minimum)	0.1
Initial Direct Subst. Iterations	3
Direct Subst. Iterations after each Wegstein Iter...	0
Trace Mole-fraction Limit	1.0e-6

Convergence Method: Three different convergence methods are available:

- Wegstein
- Newton
- Avg. Wegstein

A brief explanation of how these methods work is given below:

Wegstein's Method: The traditional method of converging a recycle loop. In this method, the update guess for the tear stream is given by:

$$X_{n+1} = (1 - \theta)F(X_n) + \theta X_n$$

Where

$$\theta = \frac{s}{s - 1}$$

and

$$s = \frac{F(X_n) - F(X_{n-1})}{X_n - X_{n-1}}$$

The value of θ can give an indication of the quality of convergence:

θ (theta) = 1	Direct substitution
θ (theta) < 1	Slow, stable convergence
θ (theta) > 1	Can speed convergence, but can introduce instability

Direct substitution:

In this method, the previously computed stream values become the input for the next iteration. This method is often slow to converge.

$$X_{n+1} = F(X_n)$$

Newton's Method: This method perturbs each material balance group (MBG), temperature, pressure, and flow to obtain a matrix of derivatives. This allows for a slope-like technique to converge a recycle stream. This is very useful when the Wegstein method seems to be unstable.

Newton's method requires the derivative information for obtaining the guess for the next iteration.

$$X_{n+1} = X_n - \frac{F'(X_n)}{F(X_n)}$$

Where $F'(X_n)$ is the analytical/numerical derivative.

Average Wegstein's Method: This method uses the previous 3 Wegstein theta values and averages them. This becomes the new theta value. The method then uses a rolling average based on the last three theta values to set the new theta value.

Max Iterations: Change the default number of iterations that will be performed before a non-convergent case will be terminated.

Not Converged Rule: The choice to continue or stop when a loop does not converge.

Temperature Tolerance (°C): Temperature tolerance that determines when the case converges.

Flow Tolerance: Flow tolerance that determines when the case converges.

Restart Options

This facility provides the user with the option to initialize a recycle stream or a multi-stage process block using the results from the previous case run.

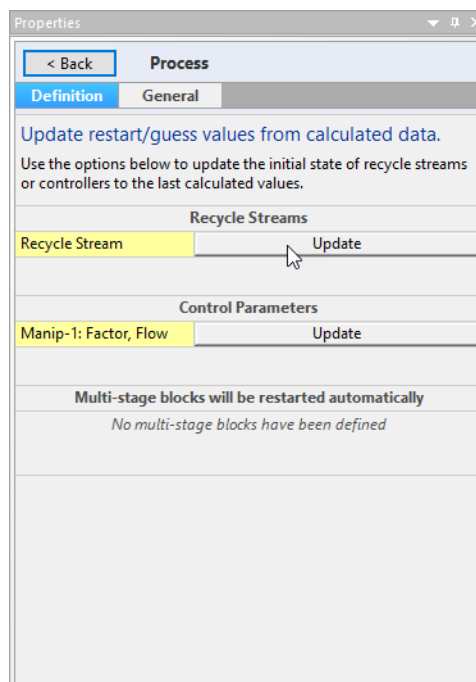

Molecular Conversion Weights

The solver uses weight factors to convert true (speciated) composition to apparent (molecular) composition. If individual weight factors are specified, the component with the bigger number will be favored in converting to molecular flows.

< Back Process

Definition General

Select True->Molecular Conversion Option

The solver uses weight factors to convert true (speciated) composition to apparent (molecular) composition.

If individual weight factors are specified, the component with the bigger number will be favored in converting to molecular flows.

Automatic
 Inflow Rate Based Weight Factors
 Specify Individual Weight Factors

Specify Weight Factors Between 1 and 10

H2O	
NH3	
CO2	
SO2	
HCl	
H2SO4	
NaOH	
NaCl	
NaHCO3	
Na2CO3	
Na2SO4	
(NH4)2SO4	

Liq-2 Key Component

In the MSE framework, the selected key component will determine the liquid-1 and liquid-2 phase split in the case when only a single liquid phase forms. When the mole fraction of the selected component in the liquid phase is more than the specified threshold value, the liquid phase will be treated as the liquid-2 phase. The Liq-2 key component options let a user choose their own key component from a chemistry model.

Properties

< Back Process

Definition General

Select second liquid phase key component

In the MSE framework, the selected key component will determine the liquid-1 and liquid-2 phase split in the case when only a single liquid phase forms.

When the mole fraction of the selected component in liquid phase is more than the specified threshold value, the liquid phase will be treated as the liquid-2 phase.

Total Hydrocarbon (default)
 CO2
 H2O
 H2SO4
 HCl
 NH3
 SO2
 SO3

Mole Fraction Threshold 0.5

Properties Watch

Calculation Aids

One of the current calculation aids is to enable trace. This option will create a file with the .oue extension and contain a detailed convergence history for all Process Blocks. This is useful in determining probable causes for the nonconvergence of Process Block calculations.



Block Calculation Order

This option will allow the user to specify the order of the blocks to be calculated.

The user can change the order of the process by using the Move Up or Move Down Buttons.

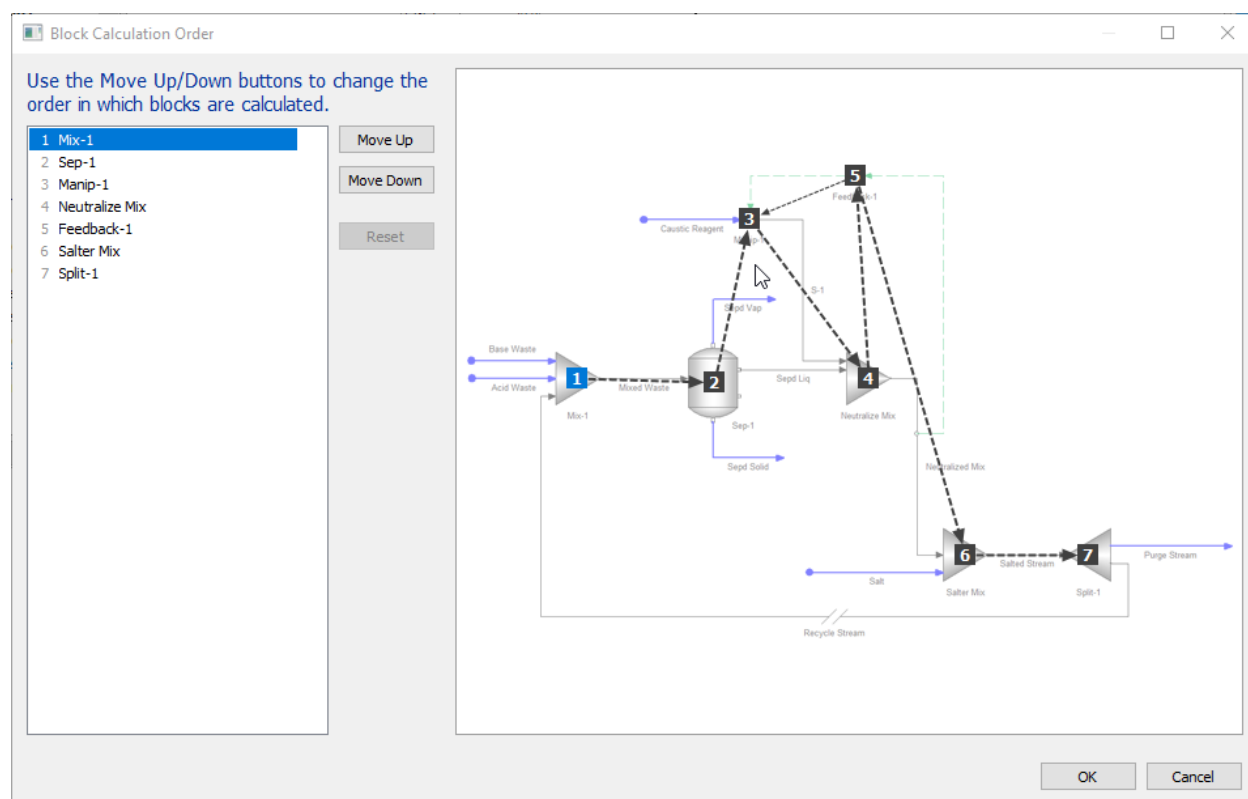

Chapter III – Reports

Let us consider the pH Neutralization with Feedback control and recycle:

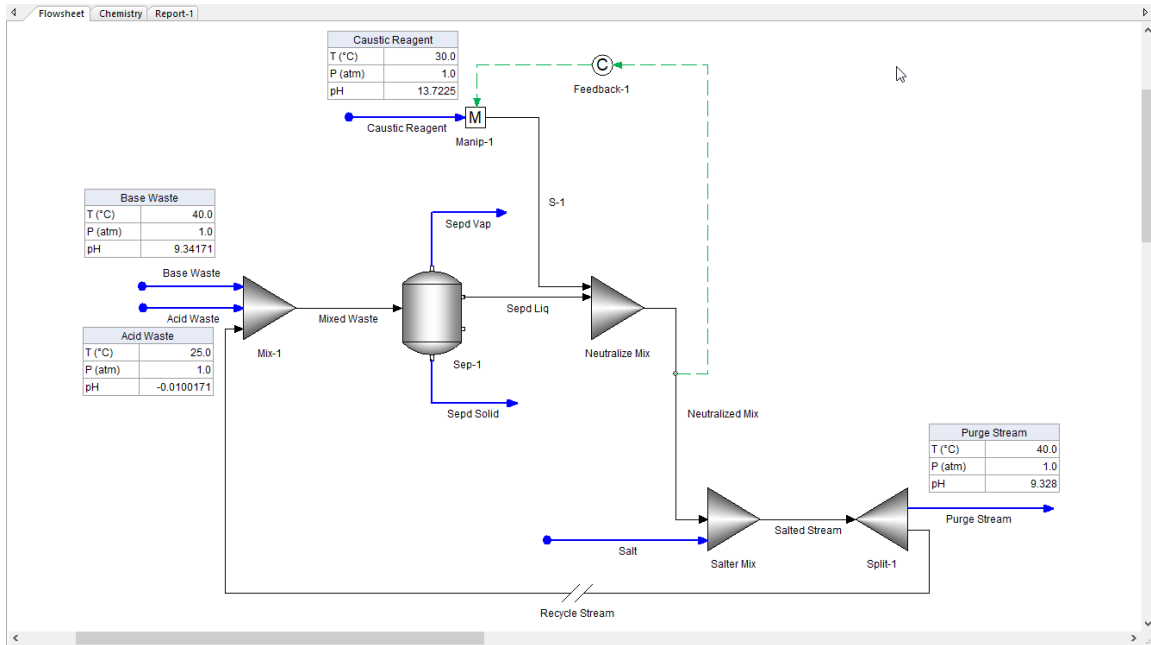

In the Report Tab, we have the following options:

- Add a Stream Report
- Add a Block Report
- Add Multi-Stream Report
- Add Overall Process Balance Report
- Add Water Analysis Report
- Customize
- Export

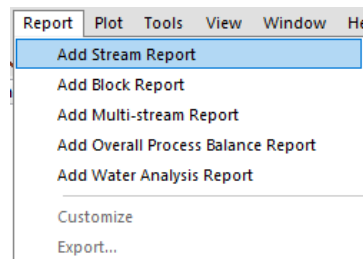

Stream Report

When using the Stream Report, the user can select a stream for analyzing its properties. Just use the drop-down arrow to select the desired stream:

The screenshot shows a software window titled 'Report-7' with a 'Select a stream' dropdown menu. A red arrow points to the dropdown arrow. The menu is open, showing a list of stream types. The selected stream is 'Base Waste'. The report table below shows the following data:

Base Waste				
Stream Parameter				
Temperature (°C)	40.0			
Pressure (atm)	1.0			
pH	9.34171			
Solid Frac. (mole %)	0.0			
Vapor Frac. (mole %)	0.0			
Phase Flows				
	Liquid-1	Solids	Vapor	Total
Moles, True (mol/hr)	199.295	0.0	0.0	199.295
Moles, Apparent (mol/hr)	200.0	0.0	0.0	200.0
Mass (g/hr)	3625.0	0.0	0.0	3625.0
Volume (L/hr)	3.62947	0.0	0.0	3.62947
Thermodynamic Properties				
	Liquid-1	Solids	Vapor	Total
Density (g/ml)	0.998769	0.0	0.0	
Enthalpy (cal/hr)	-1.34669e7	0.0	0.0	-1.34669e7
Ionic Strength (mol/kg)	0.441208			
Ionic Strength (mol/mol)	7.78516e-3			
Osmotic Pressure (atm)	26.5095			
Std. Liquid Volume (L/hr)	3.62833	0.0	0.0	3.62833
Composition, True (Speciated)				
	Liquid-1 (mol/hr)	Solids (mol/hr)	Vapor (mol/hr)	Total (mol/hr)
<i>Row filter applied: only show non-zero rows</i>				
H2O	195.199		0.0	195.199
NH3	2.26135		0.0	2.26135
NH4+1	1.12858			1.12858
SO3-2	0.35199			0.35199
HCO3-1	0.144743			0.144743
NH2CO2-1	0.136895			0.136895
CO3-2	0.0709692			0.0709692
HSO3-1	6.92426e-4			6.92426e-4

The Stream Report can be customized with additional properties:

The screenshot shows the 'Stream Report' interface for 'Base Waste'. The report is divided into several sections: Stream Parameters, Phase Flows, Thermodynamic Properties, and Composition. A 'Customize - Report-6' dialog box is open, allowing users to select report sections to customize. The dialog has a 'Contents' list with checkboxes for various sections like Stream Parameters, Phase Flows, Thermodynamic Properties, etc. A red circle '1' points to the 'Customize' button in the top right of the report window. A red circle '2' points to the 'Stream Parameters' checkbox in the 'Contents' list of the dialog. A red circle '3' points to the 'OK' button at the bottom right of the dialog.

Block Report

The block report allows the user to view the general information for a specific block. Additionally, the information shown in this table can also be customized.

The screenshot shows the 'Block Report' interface for 'Mix-1'. The top shows 'Flowsheet Chemistry Report-1 X' and a dropdown menu for 'Select a block' with 'Mix-1' selected. A red arrow points to the dropdown arrow. Below is a table titled 'Mix-1' showing 'Standard Block Information' with columns for Heat Duty, Total Mass, and Total Energy, and rows for In, Out, and Relative Diff.

Mix-1			
Standard Block Information			
Heat Duty (cal/hr)	0.0		
	In	Out	Relative Diff.
Total Mass (g/hr)	11560.6	11560.6	2.67484e-15
Total Energy (cal/hr)	-3.97062e7	-3.97062e7	0.0

Multi-stream Report

The Multi-stream Report gives us the advantage of showing information from different streams for comparison purposes. You can add either all streams of interest or just specific streams.

To add an additional stream, you need to click on the drop-down arrow and select the stream of interest, as is shown in the image below:

	Acid Waste	Base Waste	Caustic Reagent	Mixed Waste	Neutralized Mix	Purge Stream	<Select a Stream>
	Remove	Remove	Remove	Remove	Remove	Remove	<Select a Stream>
Stream Parameters							
Temperature (°C)	25.0	40.0	30.0	40.0967	40.8035	40.0	<Recycle Stream>
Pressure (atm)	1.0	1.0	1.0	1.0	1.0	1.0	S-1
pH	-0.0100171	9.34171	13.7225	1.27173	9.00016	9.328	Salted Stream
Moles, True (mol/hr)	153.321	199.295	101.77	592.714	819.878	715.521	Seprd Liq
Moles, Apparent (mol/hr)	152.65	200.0	100.0	569.987	794.35	652.013	Seprd Solid
Mass (g/hr)	2919.34	3625.0	1840.43	11560.6	15682.0	15048.9	Seprd Vap
Volume (L/hr)	2.7572	3.62947	1.78035	18.3379	14.4563	12.2234	
Solid Frac. (mole %)	0.0	0.0	0.0	0.0	0.0	1.88916	
Vapor Frac. (mole %)	0.0	0.0	0.0	0.0544738	0.0	0.0	
Phase Flows							
Moles - Aqueous (mol/hr)	153.321	199.295	101.77	592.404	819.878	703.203	
Moles - Solid (mol/hr)	0.0	0.0	0.0	0.0	0.0	12.3176	
Moles - Vapor (mol/hr)	0.0	0.0	0.0	0.310494	0.0	0.0	
Moles, Apparent - Aqueous (mol/hr)	152.65	200.0	100.0	569.677	794.35	639.695	
Mass - Aqueous (g/hr)	2919.34	3625.0	1840.43	11540.0	15682.0	14329.0	
Mass - Solid (g/hr)	0.0	0.0	0.0	0.0	0.0	719.874	
Mass - Vapor (g/hr)	0.0	0.0	0.0	13.6277	0.0	0.0	
Volume - Aqueous (L/hr)	2.7572	3.62947	1.78035	10.3982	14.4563	11.8907	
Volume - Solid (L/hr)	0.0	0.0	0.0	0.0	0.0	0.332697	
Volume - Vapor (L/hr)	0.0	0.0	0.0	7.93965	0.0	0.0	
Thermodynamic Properties							
Density - Aqueous (g/ml)	1.05881	0.998769	1.03375	1.11048	1.08479	1.20506	
Density - Solid (g/ml)	0.0	0.0	0.0	0.0	0.0	2.16375	
Density - Vapor (g/ml)	0.0	0.0	0.0	1.71641e-3	0.0	0.0	
Enthalpy (cal/hr)	-1.06222e7	-1.34669e7	-6.89948e6	-3.97062e7	-5.51796e7	-4.68513e7	
Enthalpy - Aqueous (cal/hr)	-1.06222e7	-1.34669e7	-6.89948e6	-3.96783e7	-5.51796e7	-4.56428e7	
Enthalpy - Solid (cal/hr)	0.0	0.0	0.0	0.0	0.0	-1.2085e6	
Enthalpy - Vapor (cal/hr)	0.0	0.0	0.0	-2.7854.8	0.0	0.0	
Ionic Strength - Aqueous (mol/kg)	1.40637	0.441208	1.0	3.46057	2.64976	7.03867	
Ionic Strength - Aqueous (mol/mol)	0.0243059	7.78515e-3	0.0173888	0.0559741	0.0440247	0.102261	
Osmotic Pressure (atm)	58.9401	26.5095	51.0009	177.231	126.907	448.82	

Overall Process Balance Report

The overall process balance report displays information on all process inlets and outlets, as well as calculated data for various blocks.

A material balance group table is also displayed.

The information in this report (and all the reports previously explained) can be exported in a .csv file, for posterior analysis in Excel.

Overall Process Balances				
Inlet	Flow g/hr	Enthalpy cal/hr		
Acid Waste	2919.34	-1.06222e7		
Base Waste	3625.0	-1.34669e7		
S-1	4134.97	-1.55013e7		
Salt	4383.22	-7.37201e6		
Total	15062.5	-4.69624e7		
Outlet	Flow g/hr	Enthalpy cal/hr		
Purge Stream	15048.9	-4.68513e7		
Seprd Solid	0.0	0.0		
Seprd Vap	13.6277	-2.7854.8		
Total	15062.5	-4.68792e7		
Block	Heat Duty cal/hr			
Salter Mix	83186.0			
Total	83186.0			
Material Balance Group	Inlet g/hr	Outlet g/hr	Difference g/hr	Relative Difference
C(+4)	4.23611	4.2361	-1.6051e-5	-3.78909e-6
Cl(-1)	2668.37	2668.37	4.9351e-8	1.84948e-11
H(+1)	1156.37	1156.37	-2.1507e-7	-1.85988e-10
N(-3)	49.3991	49.3991	2.27374e-13	4.60279e-15
Na(+1)	1815.65	1815.65	-1.74611e-7	-9.61699e-11
O(-2)	9272.23	9272.23	-5.40063e-5	-5.82453e-9
S(+4)	11.3091	11.3091	-9.48611e-6	-8.38802e-7
S(+6)	84.9683	84.9683	6.91358e-11	8.13666e-13

Water Analysis Report

The water analysis report shows the water analyses you have specified. You can select the water analysis in the drop-down menu. You can also customize the report and export it to a .csv file to open in Excel.

Water Analysis-1				
Stream Parameters				
Temperature (°C)	25.0			
Pressure (atm)	1.0			
pH	6.9913			
Alkalinity (mg HCO ₃ /L)	2.09645			
Phase Flows				
	Liquid-1	Solids	Vapor	Total
Moles, True (mol/hr)	55.3468	0.0	0.0	55.3468
Moles, Apparent (mol/hr)	55.3418	0.0	0.0	55.3418
Mass (g/hr)	997.224	0.0	0.0	997.224
Volume (L/hr)	1.0	0.0	0.0	1.0
Phase Fraction				
	Liquid-1	Solids	Vapor	Total
Mole Fraction, True (mole %)	100.0	0.0	0.0	100.0
Mole Fraction, Apparent (mole %)	100.0	0.0	0.0	100.0
Mass Fraction (mass %)	100.0	0.0	0.0	100.0
Volume Fraction (vol %)	100.0	0.0	0.0	100.0
Thermodynamic Properties				
	Liquid-1	Solids	Vapor	Total
Density (g/ml)	0.997224	0.0	0.0	
Enthalpy (J/hr)	-1.58187e7		0.0	-1.58187e7
Ionic Strength (mol/mol)	1.08736e-4			

Chapter IV – Chemistry Models

Overview

In most cases, the user defines a chemistry model by simply entering the names of the chemicals to be covered by the model, and the software does the rest. However, this chapter describes all the advanced facilities available to the user.

This section describes in detail the requirements to build a Chemistry Model. The Chemistry Model is important as it describes the specific chemical species and chemical equilibria involved in the application being considered.

The building of a basic Chemistry Model is a quick and simple operation. It is also an essential requirement for the modeling of an electrolyte system. Generally, from a user statement of molecular chemical species, a model is automatically created by the software. This file contains a list of the chemical species in each phase (i.e., vapor, aqueous molecules and ions, and anhydrous and hydrated solids) and the corresponding thermodynamic phase and aqueous speciation equilibrium relationships for the system.

For many OLI applications, this created model is all that is needed to describe the chemistry of the system. However, if required, the model can be augmented by the user to include chemical reaction kinetics and surface phenomena.

Chemistry Tab

The OLI Flowsheet: ESP chemistry model is accessible via the **Chemistry** tab on the PFD. It is recommended that the user start with some basic chemistry before building the process.

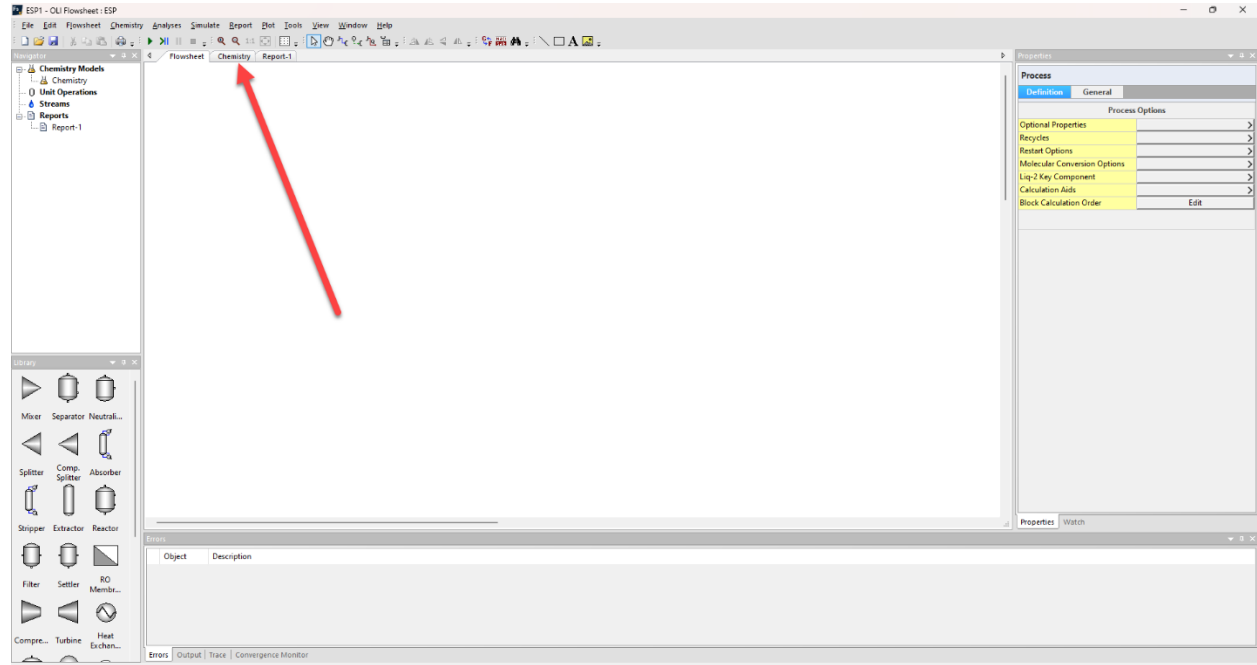

Locating the Chemistry Model

Clicking on the **Chemistry** tab will display the options for the chemistry model.

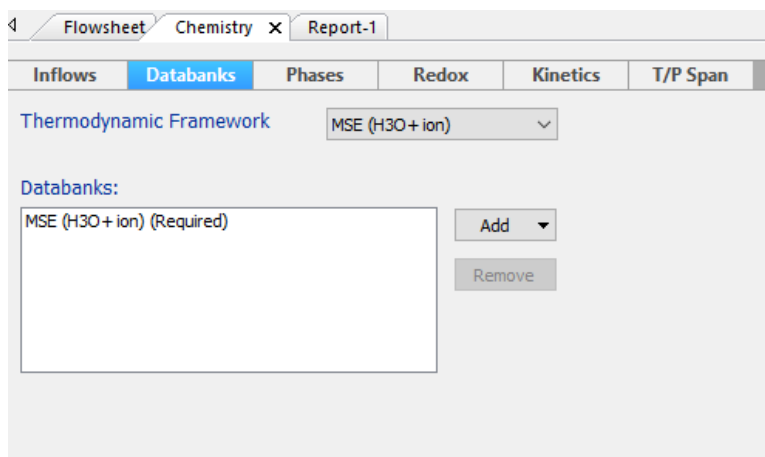

We start on the default tab **Databanks**. Here, we will modify the datasets used for this process if required.

Thermodynamic Framework

The user can choose between the default **MSE (H3O+ ion)** framework, the **MSE-SRK (H3O+ ion)** framework, or the **Aqueous (H+ ion)** framework.

The default version of the thermodynamic framework is the MSE (H3O+ ion) framework



Databanks

The default databank for each thermodynamic framework is shown. The user cannot make any modifications to the default databank. For the AQ thermodynamic framework, the default databank is **Aqueous (H+ ion)**. For the MSE thermodynamic framework, the default databank is **MSE (H3O+ ion)**.

The Add button enables users to add additional databanks to the process. Here we are showing the installed additional databases for the AQ thermodynamic framework.

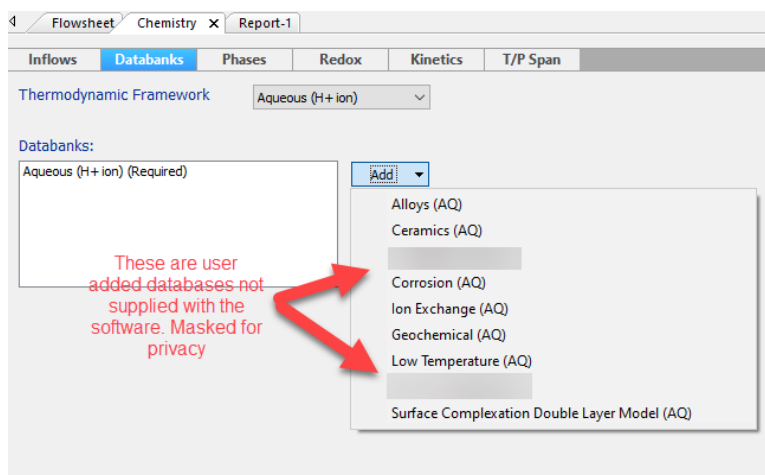

The user just selects the desired databank, and it is added to the current list. For this example, we are selecting a commonly used databank, **Geochemical**.

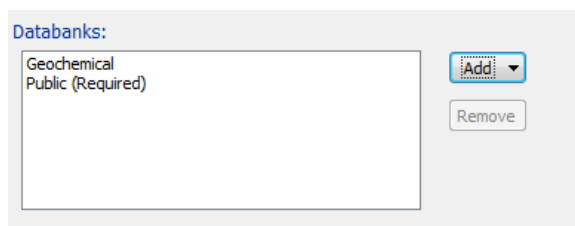

To remove a databank, simply highlight the databank and then click the **Remove** button. The default (required) databank cannot be removed.

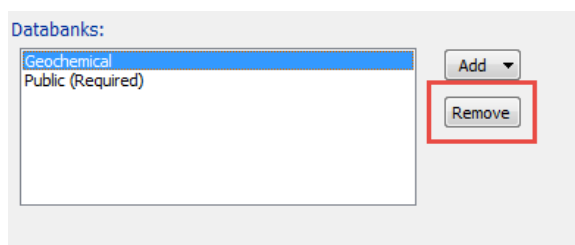

What are the OLI Supplied Databanks?

Below is a list of the databanks supplied with the OLI Flowsheet: ESP program:

AQ Databank Name	MSE Databank Name	Description
Alloys	<none>	This contains special solids that are like alloys. Such an example are CuNi alloys. This is an AQ thermodynamic framework only databank. There is no corresponding MSE databank
Ceramics	<none>	This contains special solids that are like ceramics. This was to support work done for the ceramics lab at the Rutgers University. This is an AQ thermodynamic framework only databank. There is no corresponding MSE databank
Corrosion	MSE Corrosion	This contains special elements to generate Pourbaix diagrams. Some of the species have had their Gibbs Free Energy of Formation values adjusted to match traditional Pourbaix Diagrams. It is not recommended for use with OLI Flowsheet: ESP
Exchange	<none>	This contains ion-exchanging resins. This is an AQ thermodynamic framework only

		databank. There is no corresponding MSE databank
Geochemical	MSE Geochemical	This contains minerals that are primarily found in geothermal applications. These minerals typically do not reform under traditional chemical process conditions.
Low Temperature	<none>	This databank contains minerals that form below 0°C (273.15 K). This is an AQ thermodynamic framework only databank. There is no corresponding MSE databank
Surface Complexation Capacitance Model	<none>	This databank contains surface species following Dzombak's model for capacitance. This is an AQ thermodynamic framework only databank. There is no corresponding MSE databank
Surface Complexation Double Layer Model	Surface Complexation Double Layer Model (MSE)	This databank contains surface species following Dzombak's model for Double-layers capacitance.
Surface Complexation Non-Electrostatic Model	<none>	This databank contains surface species following Dzombak's model for non-electrostatic interactions. This is an AQ thermodynamic framework only databank. There is no corresponding MSE databank
Surface Complexation Triple Layer Model	<none>	This databank contains surface species following Dzombak's model for Triple-layers. This is an AQ thermodynamic framework only databank. There is no corresponding MSE databank
<none>	MSE Urea	This databank contains surface species that support high-temperature formation of urea. It is not recommended unless urea is known to form from NH ₃ and CO ₂ . Generally, such formations are kinetically limited. This is an MSE thermodynamic framework only databank. There is no corresponding AQ databank

Inflows Tab

The inflows tab is where the components you desire are entered. Unlike OLI Studio, this grid automatically searches for a component in the selected databanks. You enter the name, chemical formula, CAS number, or OLI TAG name. The displayed name is based on the Names Manager tool.

Water (H₂O) is a required inflow component even in systems where water is not present. This is a requirement of the software. Component flow rates for water may be zero in the simulation if required.

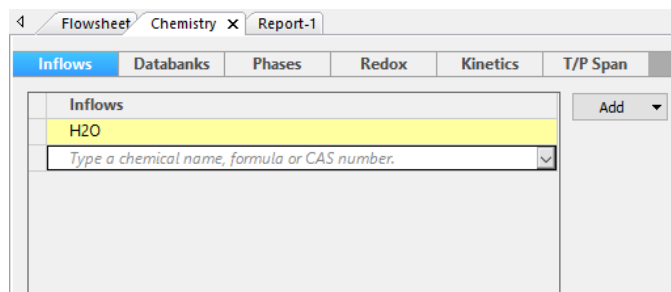

Entering a chemical name

When entering a chemical name, the grid will expand to show likely components. Here we are entering *diethylamine*.

As we started to enter text, the grid begins to start a search. At this point in Figure 2, we have only entered the text "diethyla" and all the species that contain that text are displayed. Just click the one you require.

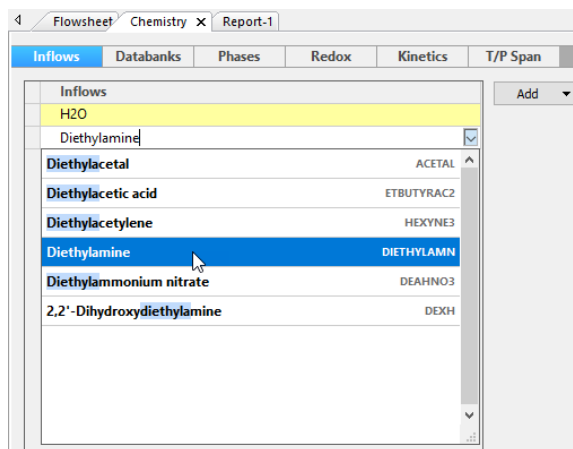
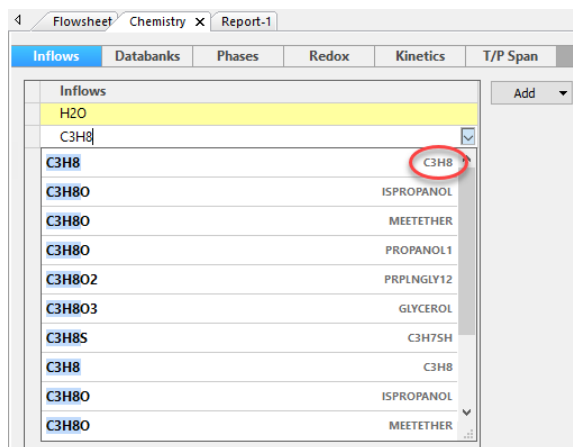

Figure 2 entering species names

You can also enter by formula, such as C₃H₈ (n-propane).

The input grid also displays alternative names (OLI TAG) for the species to the right. Users of ESP Original and some alliance partners will be familiar with these names.



Add Button

The **Add Button** allows the user to add different types of chemistry. The user can add a Pseudo-Component or a Petroleum Assay.

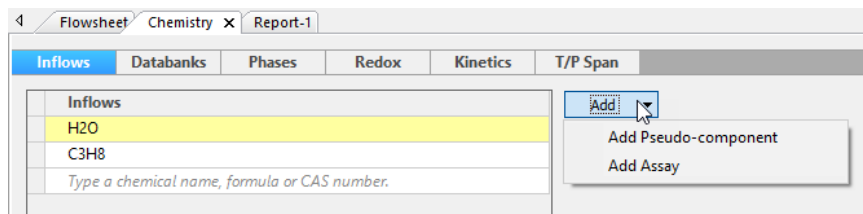

Adding a Pseudo-Component

Pseudo-components are user-created species that simulate portions of petroleum products. Typically, a user will have some analysis of an oil sample, such as assay data (boiling point data and the like), which will be broken down into individual pseudo-components. This task will be discussed in the next section. Alternatively, the user may have the data for each pseudo-component derived from other sources. This type of data can be entered via this menu item.

Select **Add Pseudo-component**

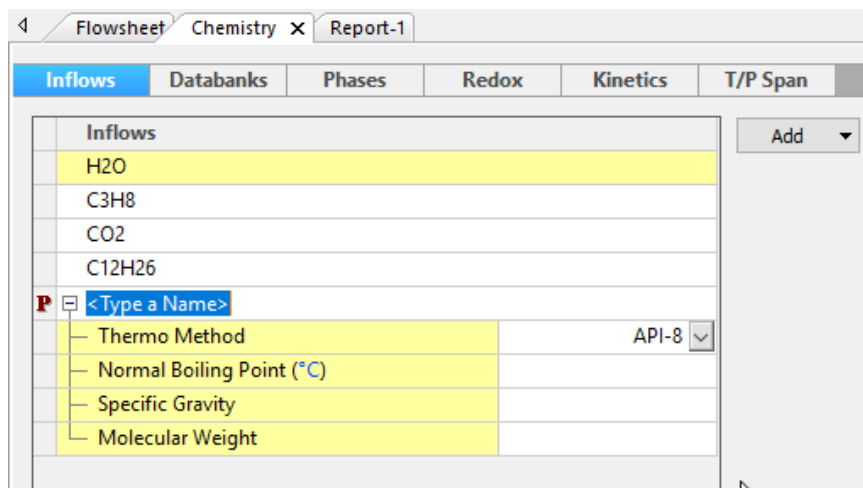

We have several items to enter for each individual pseudo-component. The first item is a name. Enter a name in the **<Type a Name>** box. This name must be unique to the model and cannot be the name of a component already in the OLI software (the program will warn you accordingly). Typically, the pseudo-component name uses the letters "PC" and some number. Here we will use the name **PC1**.

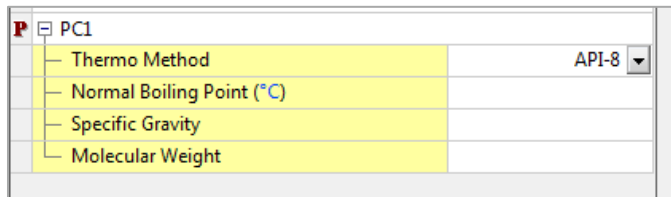

Thermo Method

We now need to define a thermodynamic method to convert the entered data to a thermodynamic entity. The default method is API-8 (American Petroleum Institute Method 8).

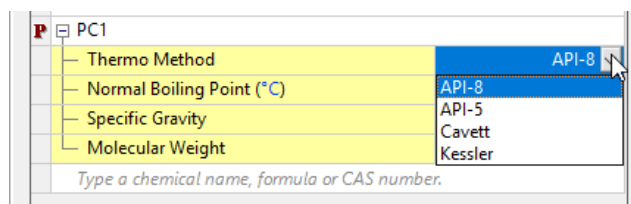

Figure 3 Available pseudo-component thermodynamic models

OLI Flowsheet: ESP supports the following methods:

- API-8 (default)
- API-5
- Cavett
- Kessler

A more detailed explanation of each method is given below:

API 8 and 5 Uses the specific gravity to estimate the critical parameters. The specific gravity, if not entered, can be estimated from the API gravity or the Watson K. The boiling points are taken from the assay data.

Cavett This method uses the API gravity method to determine the critical properties. The API gravity, if not entered, can be estimated from the actual specific gravity or the Watson K. The boiling points for the pseudo-components are taken from the assay.

Lee-Kesler This method uses the Watson K and the specific gravity (which can be estimated via the Watson K) to determine the critical parameters.

The user may enter any two of the three parameters listed in **Normal Boiling Point, Specific Gravity, and Molecular Weight**. The parameter not entered will be calculated using the selected thermo method. If all three parameters are entered, then only the parameters **Normal Boiling Point** and **Specific Gravity** will be used.

Adding an Assay

Assays are characteristics of oil samples. Typically, some sort of distillation data has been collected and will be entered into the software. This distillation data will be “Cut” into individual pseudo-components.

Click the **Add Assay** menu item.

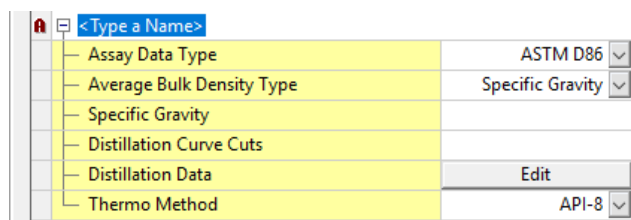

As with pseudo-components, a name is required that must be unique for this document. The name may not be the same as any component currently in the OLI software (the software will check for this). Typically, a name such as “AS” is used with a number appended (such as AS1).

The **Assay Data Types** are described in Table 1 Assay Data Types

Table 1 Assay Data Types

Assay Data Type	Description
ASTM D86	Used for light and medium petroleum products and is carried out at atmospheric pressure. The results are converted internally in the OLI model generator to a TBP (True Boiling Point) curve. This curve is then fit to a spline to smooth the curve. The cuts are taken from the spline. Examples are: Naphtha, kerosene/jet fuel, diesel, and atmospheric gas oils.
ASTM D1160	Used for heavier petroleum products and is often carried out under vacuum. Sometimes as low as 1 mmHg. The results are converted internally in the OLI model generator to a TBP (True Boiling Point) curve. This curve is then fit to a spline to smooth the curve. The cuts are taken from the spline. Examples are atmospheric bottoms/resid or vacuum bottoms/resid.
ASTM D2887	Uses gas chromatography to produce the distillation curve and is applicable to a wide range of petroleum products. The results are always reported on a volume percent basis. The results are converted internally in the OLI model generator to a TBP (True Boiling Point) curve. This curve is then fit to a spline to smooth the curve. The cuts are taken from the spline
TBP (True Boiling Point)	This is the true boiling point curve. These curves, in practice, are difficult to obtain. The other methods are usually used instead.

The **Average Bulk Density Type** is described below:

Average Bulk Density Type	Description
Specific Gravity	Relative to the density of water. No units
API Gravity	Reported in Degrees API (°API). Calculated via the following formula: $^{\circ}API(60^{\circ}F) = \left(\frac{141.5}{SG(60^{\circ}F)} \right) - 131.5$ Where, SG is the specific gravity at 60°F.
Watson K	The Watson K has no units but is calculated via: $K = \left(\frac{NBP^{\frac{1}{3}}}{SG} \right)$ Where NBP is the normal boiling point and SG is the specific gravity.

Distillation Data

The **Distillation Curve Cuts** are the number of pseudo-components that will be created from the distillation data.

The **Distillation Data** is the actual assay data. The type of data entered depends on the user selection for the **Assay Data Type**. As an example, for the method **ASTM D86**, the distillation data may look like this:

The screenshot shows a software interface with a tabbed window titled 'Flowsheet Chemistry x Report-1'. The 'Inflows' tab is active, displaying a list of chemical species: H2O, C3H8, CO2, and C12H26. Below this, a section for 'AS1' is expanded, showing several parameters: 'Assay Data Type' (ASTM D86), 'Average Bulk Density Type' (Specific Gravity), 'Specific Gravity', 'Distillation Curve Cuts', 'Distillation Data' (with an 'Edit' button), and 'Thermo Method' (API 15). An 'Add' button is visible above the list. An 'Edit Distillation Data - AS1' dialog box is open, featuring a table with two columns: 'Volume %' and 'Temperature (°C)'. The table is currently empty. At the bottom of the dialog box are 'OK' and 'Cancel' buttons.

The **Thermo Method** is the same selection for Pseudo-components above.

Once the data has been entered, the program will create the pseudo-components and display a report.

Phases Tab

The **Phases Tab** allows the user to modify the default phase behavior. In this example, we have created the following chemistry using the **Inflows Tab**.

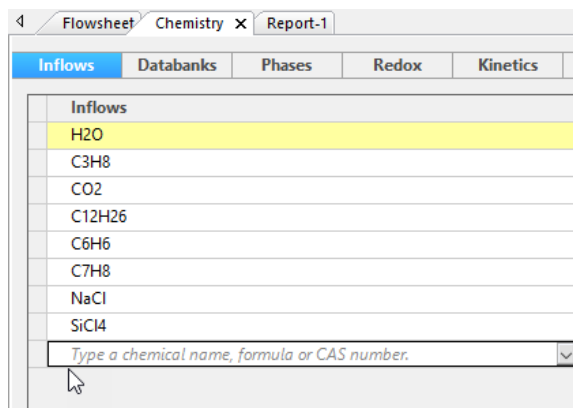

Click on the **Phases** tab.

OLI considers the possibility of a vapor phase, a second liquid phase (also referred to as an organic phase), and multiple solid phases. OLI always considers a water-rich phase referred to as Liquid 1.

The user can enable or disable phases by unchecking the phase box. In the figure, all phases have been enabled.

The user may also disable individual solid phases if they are known not to form under the conditions specified in the flowsheet. The solids are grouped by material codes and can be expanded by section.

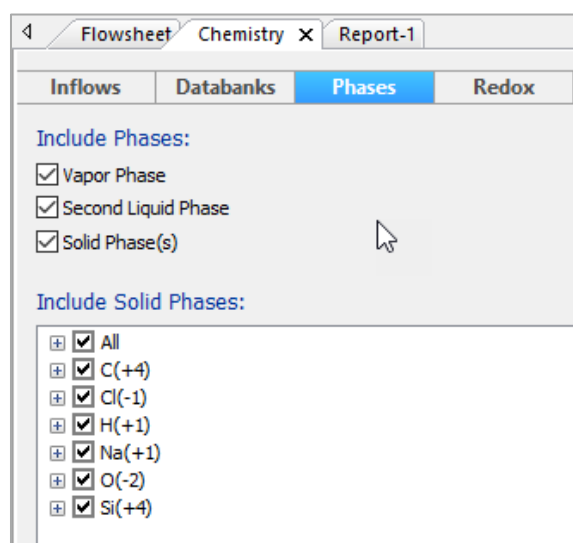

The **All** group has all the solids displayed.

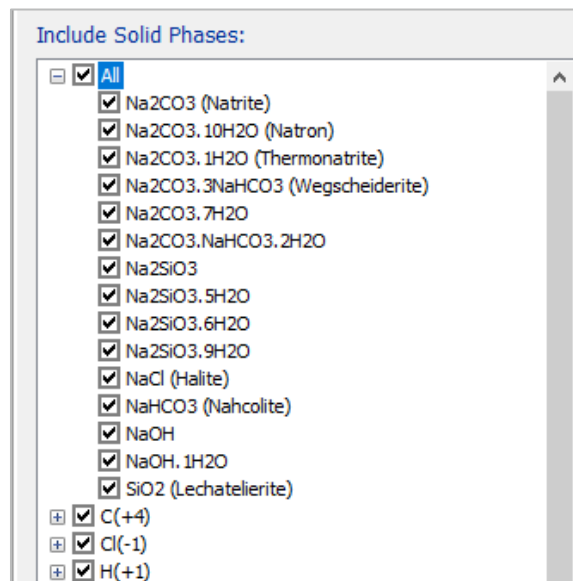

The **Na(+1)** only has species with the sodium ion (+1) material groups displayed.

Include Solid Phases:

- All
- C(+4)
- Cl(-1)
- H(+1)
- Na(+1)
 - Na₂CO₃ (Natrite)
 - Na₂CO₃.1H₂O (Natron)
 - Na₂CO₃.1H₂O (Thermonatrite)
 - Na₂CO₃.3NaHCO₃ (Wegscheiderite)
 - Na₂CO₃.7H₂O
 - Na₂CO₃.NaHCO₃.2H₂O
 - Na₂SiO₃
 - Na₂SiO₃.5H₂O
 - Na₂SiO₃.6H₂O
 - Na₂SiO₃.9H₂O
 - NaCl (Halite)
 - NaHCO₃ (Nahcolite)
 - NaOH
 - NaOH.1H₂O
- O(-2)
- Si(+4)

If the solid Na₂SiO₃ is unwanted, it can be unchecked.

You will notice that some other check boxes have turned gray. Since the species Na₂SiO₃ also contains the materials Na(+1), Si(+4), and O(-2), the corresponding check boxes in those groups have also been removed.

Include Solid Phases:

- All
- C(+4)
- Cl(-1)
- H(+1)
- Na(+1)
- O(-2)
- Si(+4)
 - Na₂SiO₃
 - Na₂SiO₃.5H₂O
 - Na₂SiO₃.6H₂O
 - Na₂SiO₃.9H₂O
 - SiO₂ (Lechatelierite)

Redox Tab

OLI Flowsheet: ESP allows for changes in oxidation state, otherwise known as REDOX. To illustrate this feature, we have created a simple chemistry model:

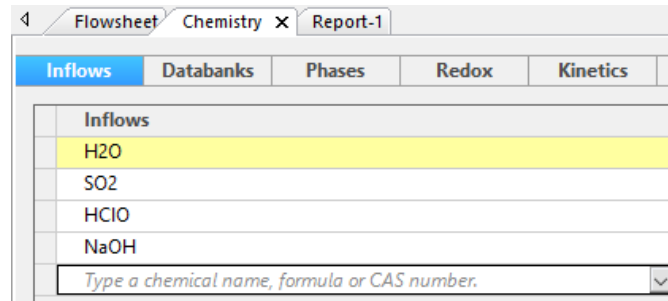

We are going to oxidize the sulfur in Sulfur dioxide - an S (+4) oxidation state - to an S (+6) state commonly found in sulfuric acid. At the same time, we will reduce the chlorine in the hypochlorous acid - a Cl (+1) oxidation state - to chloride in the (-1) oxidation state.

Click on the **Redox** tab.

By default, we do not enable Redox Chemistry. Enabling redox will add a significant number of species.

Check the **Include Redox Chemistry** box.

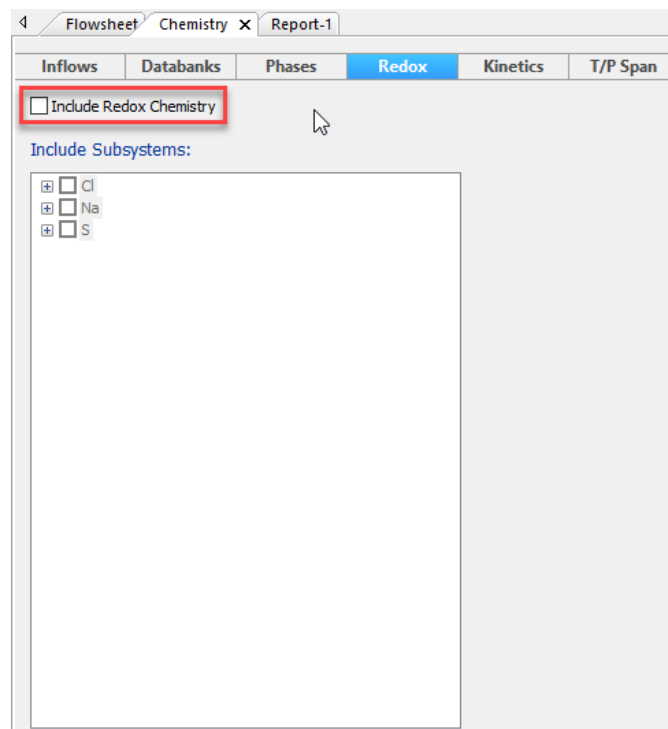

We now can select which subsystems to include. We can check the boxes to enable them. As a best practice, we should not check any elemental metals such as sodium. It is unlikely that we will form metallic sodium in our process unless we add electricity to reduce the metal. OLI Flowsheet: ESP currently does not support such processes. However, if you are starting with a stream that contains metallic sodium, then enabling this box would be appropriate.

Check the elements you require.

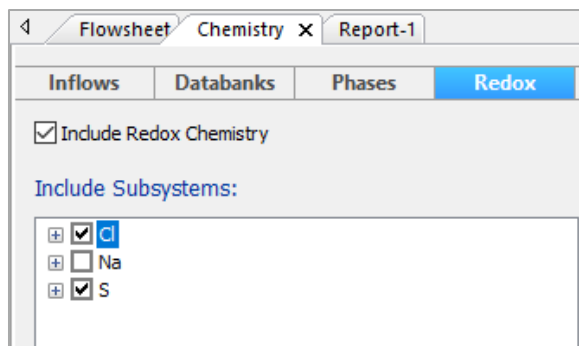

The current chemistry model now includes these species. We started with Chlorine in the (+1) oxidation state and Sulfur in the (+2) oxidation state. Let's see what we currently have in the chemistry model.

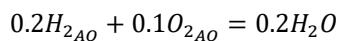
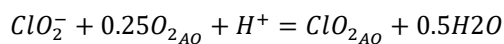
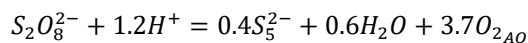
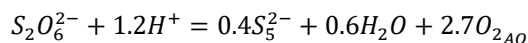
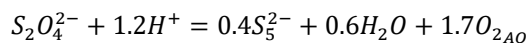
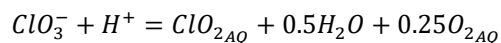
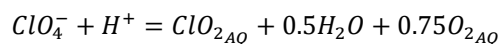
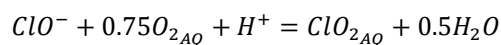
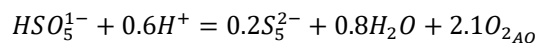
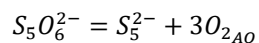
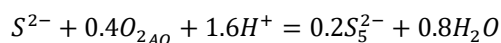
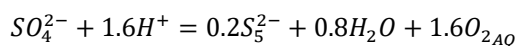
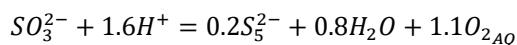
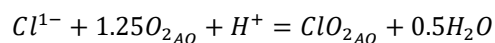

As you can see, there are quite a few species with multiple oxidation states for both chlorine and sulfur. If the user knew that only chlorides in the (-1) and (+1) oxidation states and sulfur in the (+4) and (+6) oxidation states are involved, then the model can be "adjusted" for just those oxidation states.

In the figure above, expand the "+" symbol to see more oxidation states.

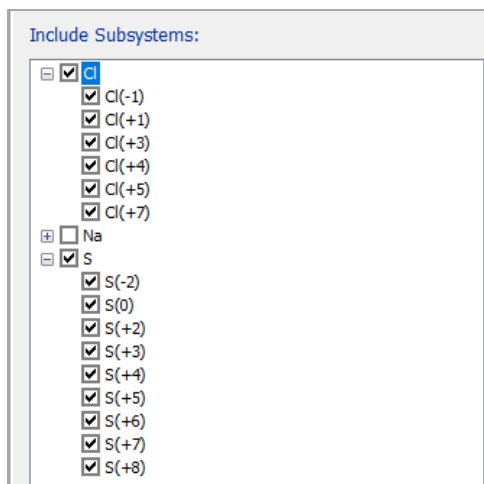

Uncheck the undesired oxidation states. In this example we are only retaining Cl(-1), Cl(+1), S(+4), and S(+6).

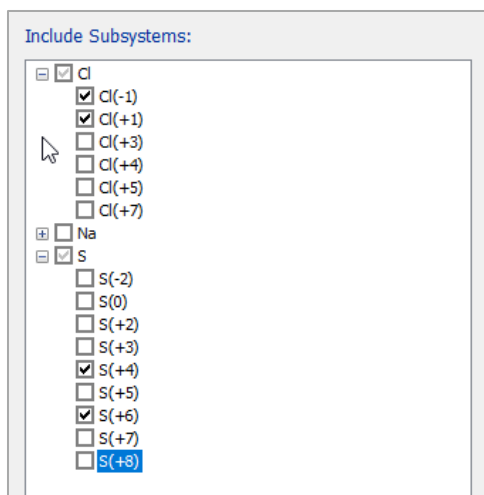

The resultant chemistry is drastically altered.

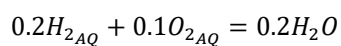
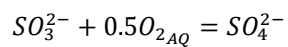
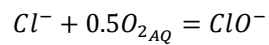

Kinetics Tab

Reaction Kinetics Overview

The OLI thermodynamic framework supports reaction kinetics. Reaction kinetics can be defined in standard Arrhenius terms or in terms defined by the user. There are only two different unit operations that support reaction kinetics: REACTOR unit and Multi-stage COLUMNS, such as STRIPPERS and ABSORBERS.

Reaction Types

There are two general types of reaction kinetics:

Type 1: Change in material balance codes across the reaction

As an example, consider the following reaction:

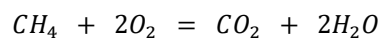

The material balance codes across the reaction are:

Species	Material Balance Codes	=	Species	Material Balance Codes
CH4	1001		CO2	25, 1
O2	57		H2O	1, 21

Due to the material balance code changes across this reaction, there will be no equilibrium reaction or any combination of equilibrium reactions to produce this reaction. This assumes that no oxidation/reduction reactions are present in the equilibrium reactions.

In fact, this is a requirement of our kinetic models that kinetics and oxidation/reduction reactions cannot be mixed. You must use all kinetic or all oxidation/reduction, not a mixture of both.

Type 2: No change in material balance codes across the reaction

Consider this reaction:



The material balance codes across the reaction are:

Species	Material Balance Codes	=	Species	Material Balance Codes
CACO3PPT	6, 25, 21		CAION	6
			CO3ION	25, 21

The material codes on both sides of the equation are the same. Therefore, the equilibrium model will contain this reaction either directly or as a combination of equilibrium reactions. To include this kinetic reaction, the equilibrium model must be changed to remove the equilibrium between these species. The software will rewrite the equilibrium reactions by removing the CACO3PPT from the equilibrium reaction set. Thus, the

only way to make or consume $\text{CaCO}_{3\text{ppt}}$ is by the kinetic reaction. If the user wants to feed $\text{CaCO}_{3\text{ppt}}$ to the reactor, an additional input has been provided in the interface routine to specify the amount of $\text{CaCO}_{3\text{ppt}}$ feed. An additional keyword has been added to the kinetics section of the model file, where the user can specify which species will be removed from the equilibrium calculation.

Kinetics Types

There are two types of kinetics available in OLI Flowsheet: ESP. The first is Arrhenius type (also known as Standard type) and the other is User type (also known as SPEC type).

Standard Rate Expressions

In this mode, the rate of reaction is calculated using a standard rate expression. This expression considers both the forward and reverse reaction rates, the individual species reaction orders, and the forward and reverse reaction constants (determined using the Arrhenius Equation).

Select a reaction from the list below or add a new one:

[3] $\text{CaCO}_3(\text{ppt}) = \text{Ca}+2 + \text{CO}_3-2$

Buttons: Add..., Modify..., Remove

Override Equilibrium Reaction: <Automatic>

Rate Definition: Arrhenius

Rate (mol/hr): $(K_F R_1^{ER1} R_2^{ER2} \dots - K_R P_1^{EP1} P_2^{EP2} \dots) \cdot V_{\text{Liq}}$

Rate is calculated using the above expression with the variables defined below.

Variable	Expression
KF (mol/m3 hr)	$A_F \cdot \text{EXP}(-BF/T)$
KR (mol/m3 hr)	$A_R \cdot \text{EXP}(-BR/T)$
AF (mol/m3 hr)	0.0
AR (mol/m3 hr)	0.0
BF (K)	0.0
BR (K)	0.0
ER1	1.0
EP1	1.0

R_i, P_i are activities (x-based) of reactants and products.
 V_{Liq} is liquid volume (m3).
 T is temperature (K).

Display OLI tag instead of formula

Buttons: OK, Cancel

The standard rate expression is best illustrated by means of an example. Consider the general equation:

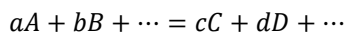

where: a, b, \dots, c, d are stoichiometric coefficients.

and: A, B, \dots are reactant species

C, D, \dots are product species

The standard rate expression is of the form:

$$Rate = (k_f a_A^{r_1} a_B^{r_2} \dots - k_r a_C^{p_1} a_D^{p_2}) \times Vol$$

where:

$Rate$ = Reaction rate $\left(\frac{mole}{hr}\right)$

k_f = Forward reaction rate constant $\left(\frac{mole}{m^3 hr}\right)$

k_r = Reverse reaction rate constant $\left(\frac{mole}{m^3 hr}\right)$

a_A, a_B, \dots = Activities of reactant species (unitless)

$r_1, r_2 \dots$ = Reaction order of individual reactant species (normally from experimental data. Default is stoichiometric coefficients; a, b, ...)

a_C, a_D, \dots = Activities of product species

p_1, p_2, \dots = Reaction order of individual product species (normally from experimental data. Default is stoichiometric coefficients; a, b, ...)

Vol = Liquid product volume (m^3)

The forward and reverse reaction rate constants are determined using the general Arrhenius Equation:

$$K = A \exp\left(-\frac{E}{RT}\right)$$

where: K = Reaction rate constant $\left(\frac{mole}{m^3 hr}\right)$

A = Arrhenius frequency factor for the forward or reverse reaction and is in $\left(\frac{mole}{m^3 hr}\right)$

E = Forward or reverse activation energy $\left(\frac{joule}{gmole}\right)$

R = Universal gas constant $\left(8.314 \frac{joule}{gmole K}\right)$

T = Temperature (K)

When specifying a standard rate expression, the user must define the Arrhenius frequency factor, reaction activation energies divided by the universal gas constant or, alternatively, the reaction rate directly. In addition, the user can specify the individual species order coefficients for the forward and reverse reactions if these differ from the stoichiometric coefficients (which are the default).

Keyword

Description

KF Forward reaction rate constant $\left(\frac{mole}{m^3 hr}\right)$

KR Reverse reaction rate constant $\left(\frac{mole}{m^3 hr}\right)$

AF	Forward reaction Arrhenius factor $\frac{\left(\frac{\text{mole}}{\text{m}^3 \text{hr}}\right)}{\text{hr}}$
AR	Reverse reaction Arrhenius factor $\frac{\left(\frac{\text{mole}}{\text{m}^3 \text{hr}}\right)}{\text{hr}}$
BF	Forward reaction activation energy divided by the universal gas constant (K)
BR	Reverse reaction activation energy divided by the universal gas constant (K)
ER_i	Reaction order of reactant species i
EP_i	Reaction order of product species i

It should be emphasized that when the keywords KF and KR , the forward and reverse reaction rate constants, respectively, are used for a reaction, this would preclude using the other keywords for that reaction. However, these keywords are not normally specified by the user, as these variables are usually calculated by the software from user-defined Arrhenius factors and activation energies.

When defining the reaction order for a species, the order in which the species appears in the reaction equation must be defined (i.e., subscript i) with a sequential number, for either the reactant or product species. Hence, the first reactant is identified with the number 1, the second with 2, and so on. Similarly, the product species are identified with the integers 1, 2, 3, ... etc.

If any of the keywords are not defined, the software assumes a default value for that variable. These default values are assumed to be zero for the reaction rate constants, Arrhenius factors, and activation energies (divided by the universal gas constant). For the species reaction order coefficients, the reaction stoichiometric values are assumed.

To complete the standard rate expression definition, the reaction temperature and initial reactant molality are included in the process stream composition definition.

You can review a full example for the Standard Reaction Kinetics on page 216 using a reactor block.

Non-Standard (User Defined) Reaction Kinetics

The user can define their own reaction kinetics.

You can review a full example for Non-standard Reaction Kinetics on page 223.

T/P Span

The T/P Span is for the temperature and pressure limits on the equation-of-state for the model. This only applies to the AQ thermodynamic framework. It is generally recommended that these values not be altered. These values are ignored for both the MSE and MSE-SRK thermodynamic frameworks.

History Lesson

Before 1990, OLI used a mixture of different thermodynamic frameworks to represent the standard state (equilibrium constants). Starting in 1990, OLI migrated to the Helgeson Equation of State⁴.

⁴ Helgeson, Harold C., Kirkham, David H. and Flowers, George, C. "Theoretical Prediction of the Thermodynamic Behavior of Aqueous Electrolytes at High Pressures and Temperatures – Parts I Through IV." American Journal of Science (1982)

This equation-of-state provided a consistent representation of the standard state for species in water up to 374 °C and 5000 atmospheres.

The problem in the 1990s was that computers were slow, and the direct method of calculating the equation of state was computationally intensive. Marshall Rafal (OLI – retired) observed that since the equation-of-state was only a function of temperature and pressure, the equilibrium constants could be pre-fit before calculation time. A matrix of temperatures (T span) and pressures (P span) was generated and then fit to a polynomial equation.

Evaluation of this polynomial is very fast, even in the 1990s, so it is used for the AQ thermodynamic framework. This was too inaccurate for the MSE thermodynamic framework, and all values in the T/P are ignored.

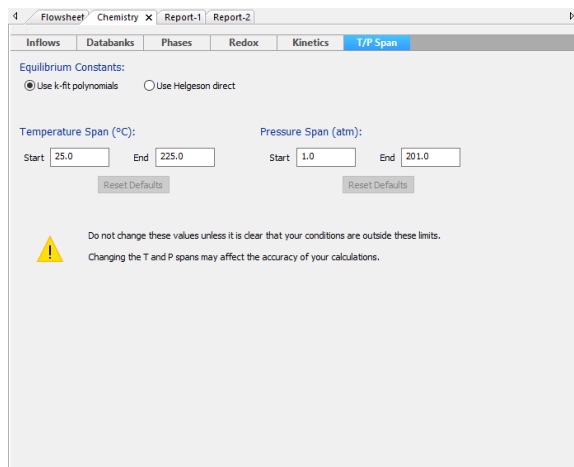

This dialog is quite easy to understand. The user has the option to use the K-fit polynomials (default for AQ thermodynamic framework use) or use the equation-of-state directly. If the K-fit polynomials are used, then the ranges (spans) can be altered.

The user would only normally alter these ranges if they knew beforehand that the simulation was outside the ranges.

Chapter V – Process Modeling Unit Operations/Blocks

Overview

This section is a detailed guide to the use of unit operations, called Process Blocks, and for the use of the steady-state flowsheet simulation facilities provided in OLI Flowsheet: ESP. This chapter contains a brief overview and detailed specifications of the OLI Flowsheet: ESP Process Blocks. Limitations and guidelines for individual units are included.

By selecting pertinent unit operations, a complete process can be modeled by combining individual process blocks into a process flowsheet to describe the process.

Unit Operations/Blocks and Controllers

The current blocks available in OLI Flowsheet: ESP are:

- Mixer
- Separator
- Neutralizer
- Splitter
- Component Splitter
- Absorber
- Stripper
- Extractor
- Reactor
- Filter
- Settler
- RO Membrane
- Compressor
- Turbine
- Heat Exchanger
- Incinerator
- Pump
- Feedback controller
- Feedforward controller
- Manipulator
- Virtual Stream Portal
- Inlet Portal (for Subflowsheets)
- Outlet Portal (for Subflowsheets)
- Calculator
- Subflowsheet

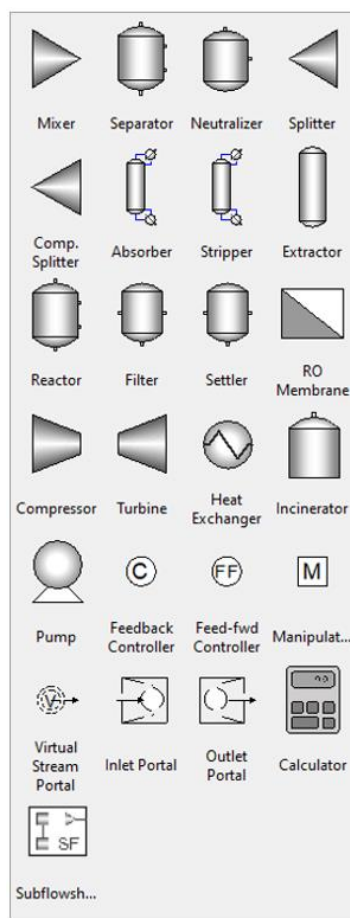

Unit Operations/Blocks and Controllers Summary Descriptions

Mixer

A conventional Process Block that allows the mixing of several inlet streams adiabatically. The resulting phase separation and speciation within each phase are also evaluated.

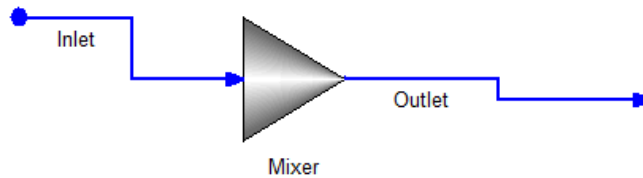

Separator

A conventional Process Block which allows inlets to be separated into distinct physical phases. Suspended solids, entrained liquid, and entrained vapor can be specified. An equilibrium will be performed adiabatically.

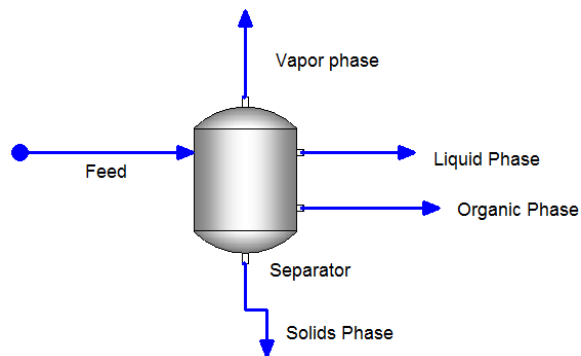

Neutralizer

An environmental Process Block which allows a specified stream to be neutralized by a reagent, either by adiabatically mixing the inlet streams, or by varying one of the inlet streams to meet a specified pH point.

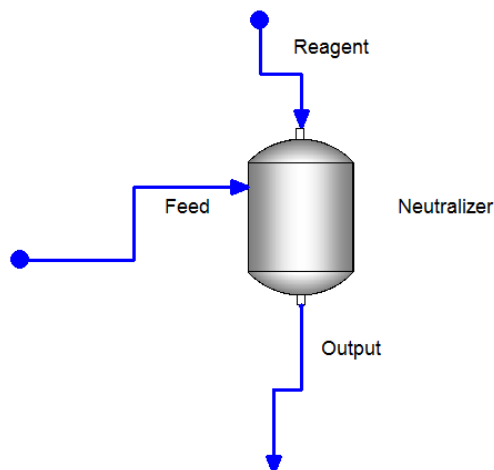

Splitter

A conventional Process Block which allows a stream to be split into required outlet flow fractions or specified flow rate for one of the streams. There are two types of splits currently supported.

Flow Split – This split allows a single inlet stream to be divided into (2-7) outlet streams, all with the same temperature, pressure, and relative species content.

Component splitter – Which is described in the next section.

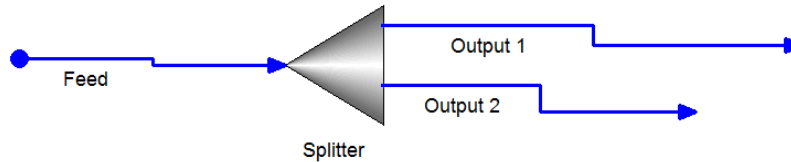

Component Splitter

This type of split allows between 1 and 7 inlet streams to be divided into 2 outlet streams, one of which contains the required species component fractions.

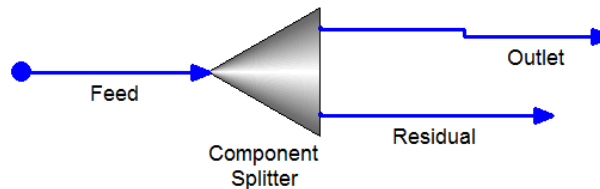

Absorber

A multi-stage or environmental Process Block which allows species in a vapor feed to be absorbed by a counter-current liquid stream. Conventional column capabilities are included, such as: multiple feeds, condenser, reboiler, side streams, pump-arounds, specification/control, and stage efficiencies.

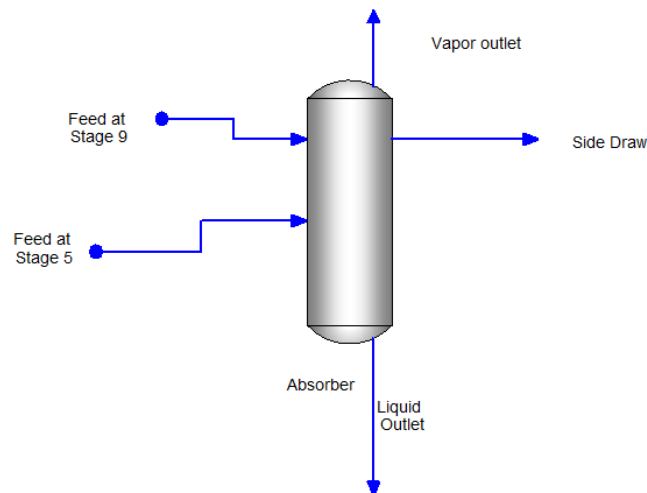

Stripper/Distillation Column

A multi-Stage conventional Process Block, allowing species in a liquid feed to be removed by a counter-current vapor stream. Conventional column capabilities are included, such as: multiple feeds, condenser, reboiler, side streams, pump-arounds, specification/control, and tray efficiencies.

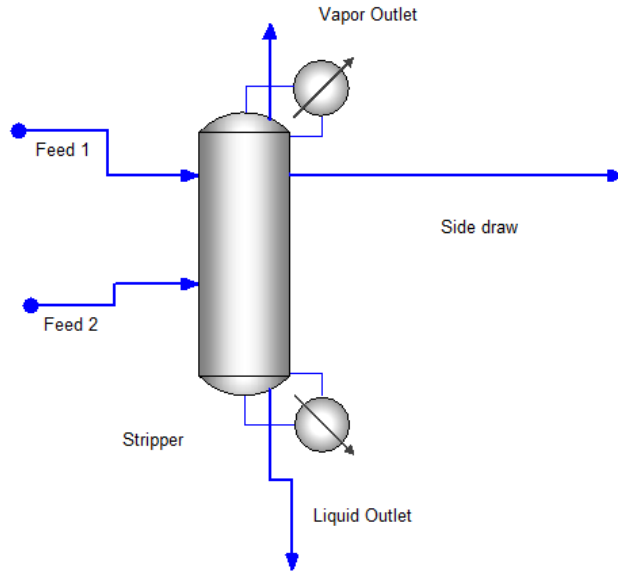

Extractor Unit

This is a multi-stage conventional Process Block that allows counter-current liquid-liquid extraction to be simulated. The unit can hold a maximum of 50 stages, 10 feed streams, and 10 exit streams. Conventional extractor unit capabilities are included, such as: multiple feeds, specification/control, and tray efficiencies.

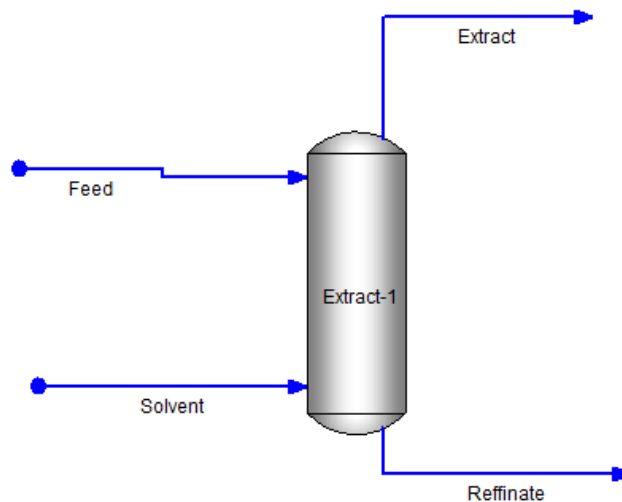

Reactor

A Process Block which determines the phase separation and intra-phase speciation for a Chemistry Model, including both equilibrium and user-defined rate-limited reactions (i.e., kinetics, redox reactions). Between 1-7 inlet streams are mixed and considered as a single feed. Up to 4 outlet streams are supported: vapor, liquid 1 (aqueous), liquid 2, and solids. There are two types of reactors currently supported. They are:

Aqueous – This reactor is used to simulate electrolyte chemical reaction systems.

Non-aqueous – This reactor is used to simulate non-electrolyte chemical reaction systems.

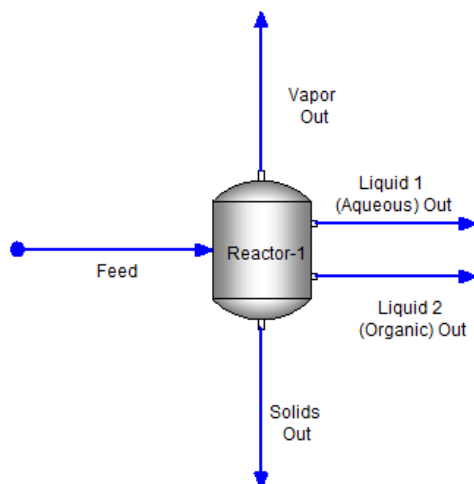

Filter

A crystallization Process Block which models the separation of the liquid portion of the feed stream from the solid portion of the feed stream. The liquid and solid are divided between the filtrate and solids outlet streams based upon specified fractions or flows.

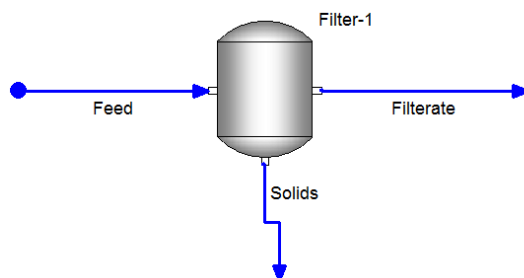

Settler

A crystallization Process Block which models the separation of the liquid portion of the feed stream from the solid portion of the feed stream. The liquid and solid are divided between the filtrate and solids outlet streams based upon specified fractions or flows. The solid may be split as a total solid or, differentially, split by individual solid species.

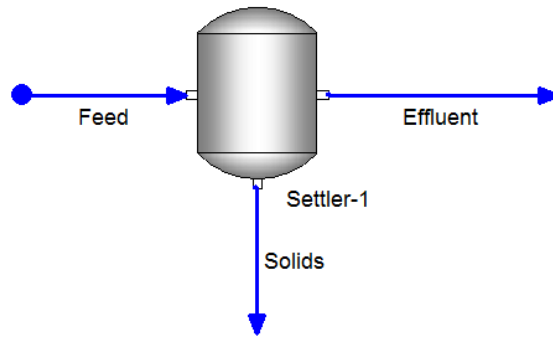

RO Membrane (Reverse Osmosis)

A Process Block which predicts the distribution (separation) of salts from a single feed and optional permeate feed, when a membrane is applied with the result that both a permeate (dilute) and concentrated product streams are created.

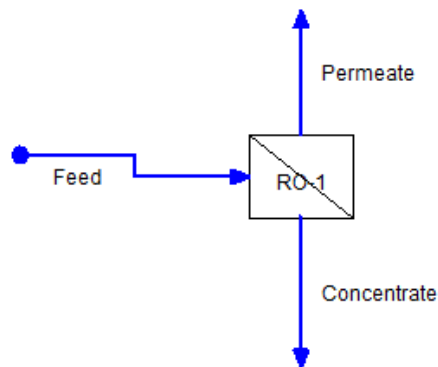

Compressor

A conventional Process Block for carrying out an isentropic or polytropic pressure change on a product stream comprised of one or more feed streams.

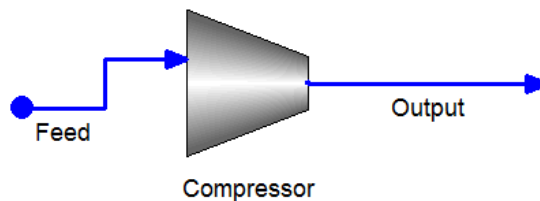

Turbine

A conventional Process Block for carrying out an isentropic or polytropic pressure change on a product stream comprised of one or more feed streams.

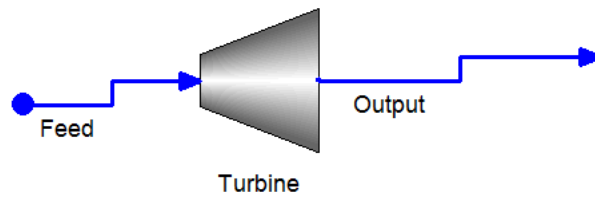

Heat Exchanger

A conventional Process Block which allows energy to be transferred between a process and a utility stream, or allows energy to be added to, or removed from, a single stream. A utility stream may also be a stream from another process block.

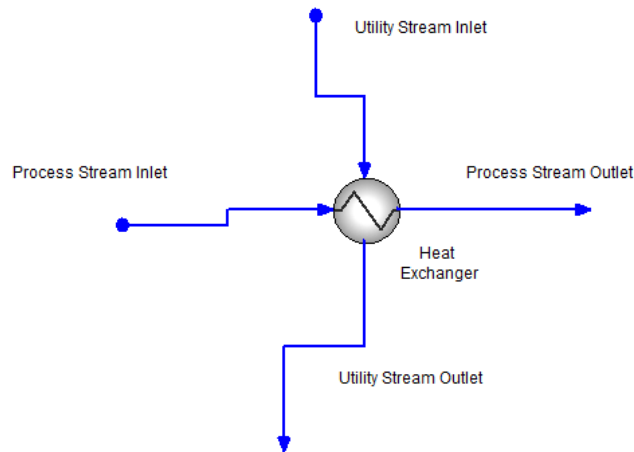
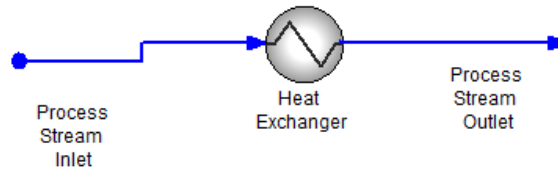

Incinerator

An environmental Process Block which allows non-electrolyte species to be incinerated either adiabatically or isothermally.

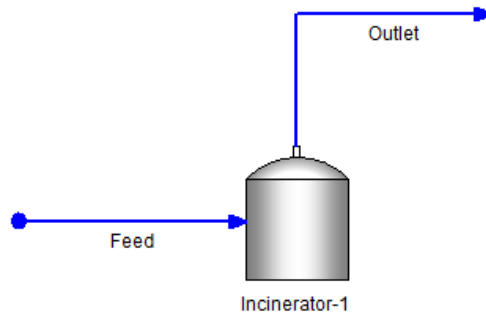

Pump

A conventional Process Block for increasing fluid pressure to a unit.

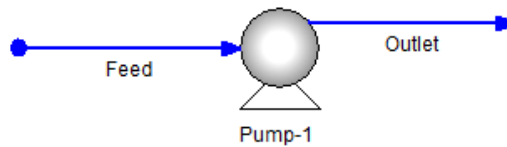

Feedback Controller

An ESP Control Block which sets a stream specification or a block parameter by transferring a block parameter from a downstream unit. The transferred value can be adjusted by addition, subtraction, multiplication, or division.

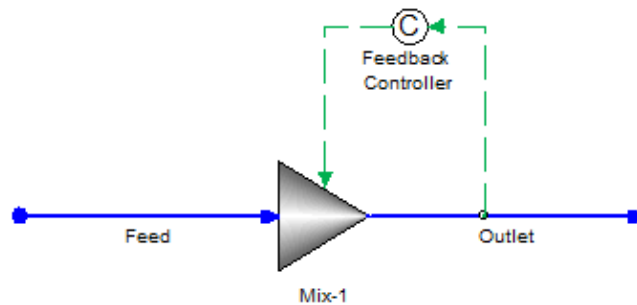

Feed-forward Controller

An ESP Control Block which sets a stream specification or a block parameter by transferring a block parameter from an upstream unit. The transferred value can be adjusted by addition, subtraction, multiplication, or division.

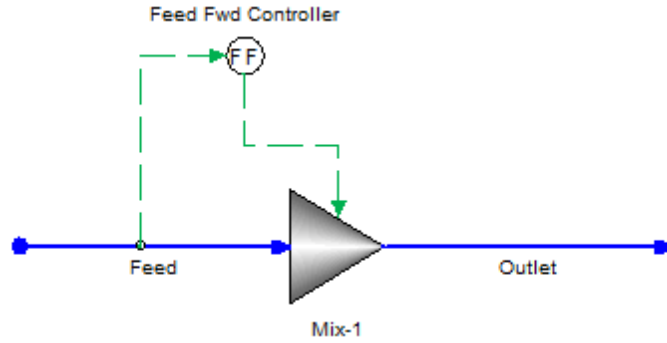

Manipulator

An ESP Control Block which allows a multiplicative factor to be applied to the total flow of a stream, or to the components of a stream.

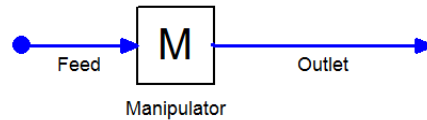

Virtual Stream Portal

This block allows a stream to be copied exactly to another place in the process. For example, the process may have a stream that requires some additional calculations to determine how close it is to scaling. We don't want to disturb the main process, so we copy the stream out and perform our scaling calculations separately.

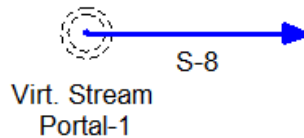

Inlet Portal

This block is used within a Subflowsheet to bring in a main flowsheet stream.

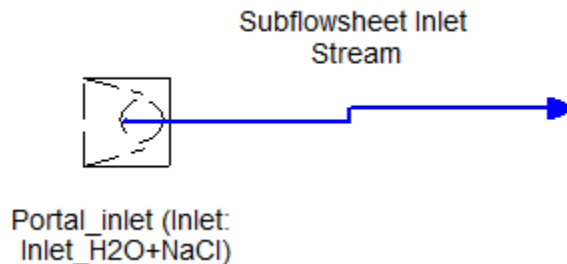

Outlet Portal

This block is used within a Subflowsheet to bring out a Subflowsheet stream to the main flowsheet.

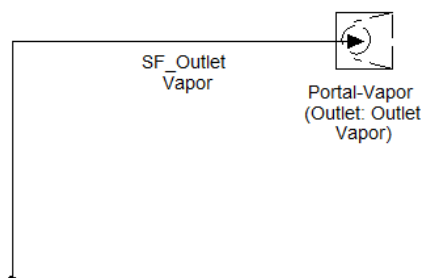

Calculator

This block allows the user to write their own calculation or property and have it applied elsewhere on the flowsheet

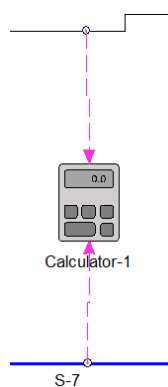

Sub-Flowsheet

This block (also called a nested flowsheet or subflowsheet model) is a modular, self-contained section of a larger simulation. Think of it like a function or subroutine in a programming language: it performs a specific task within the broader simulation and can be reused or isolated as needed.

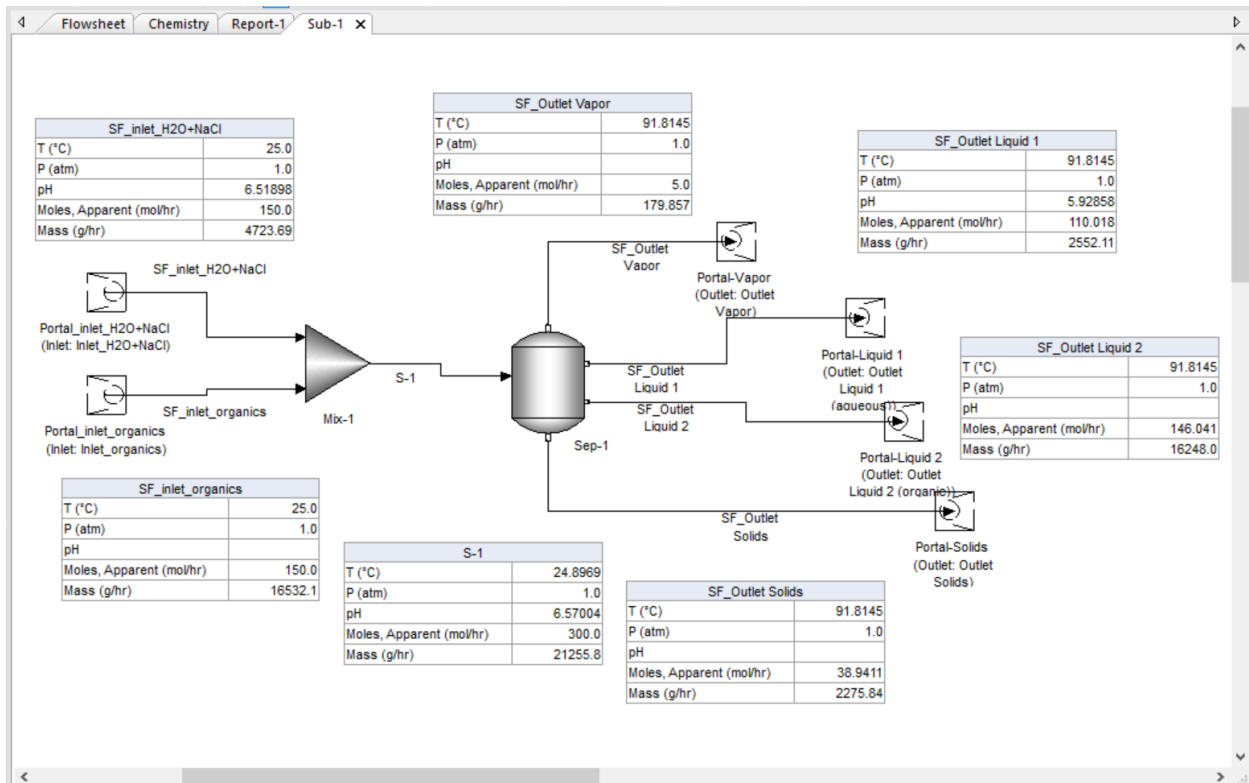
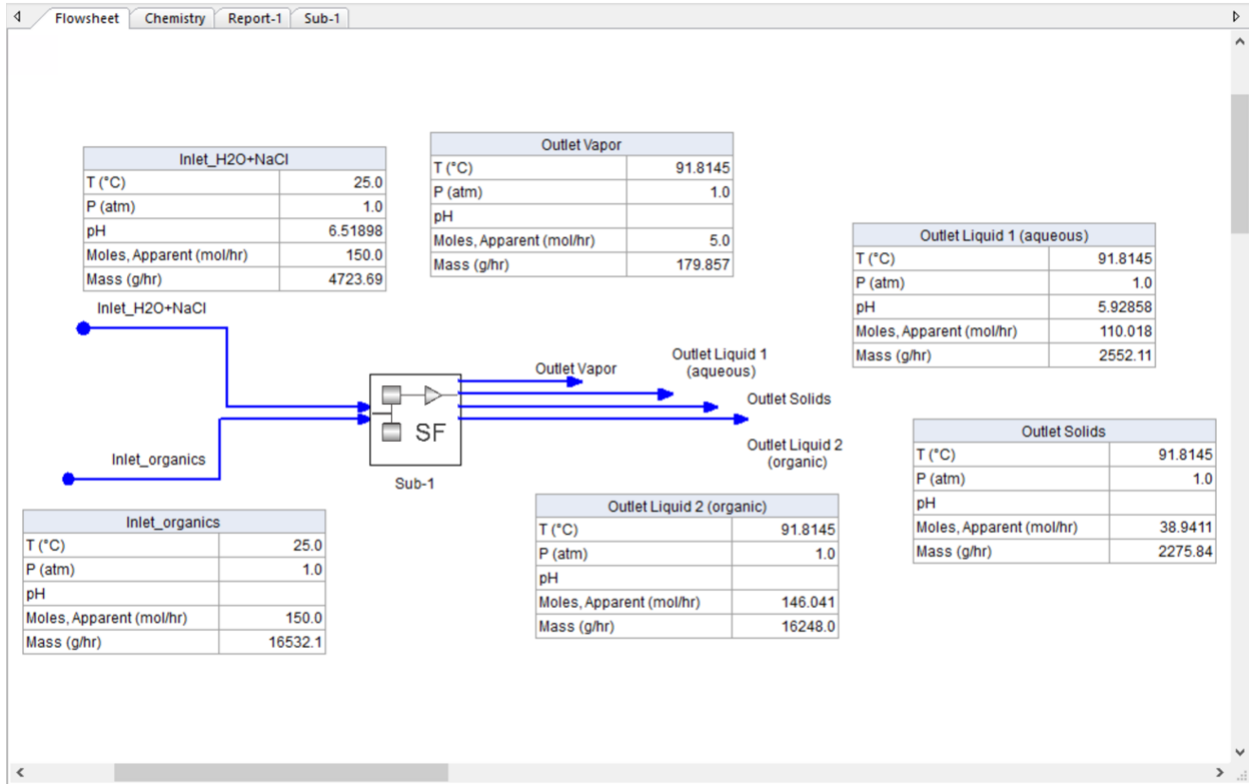

Details of Unit Operations/Blocks

This section describes in detail specific application for the blocks available in OLI Flowsheet: ESP. The procedure for defining each block is described.

1. Mixer Unit

This is a conventional Process Block that allows the mixing of up to 10 feed streams through one of several types of equilibrium calculations. The resulting phase separation and speciation within each phase is computed.

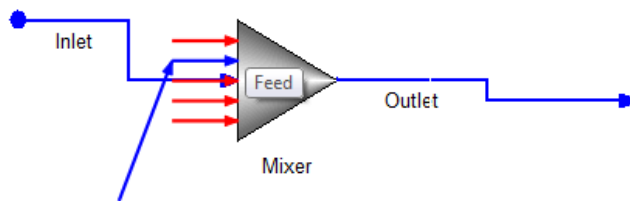

Data Requirement

The unit's stream inflows and exit flow must all be given distinct names. This enables streams and units to be recognized and linked together when building a complex process. A minimum of one feed stream and the respective temperature, pressure, flow, and composition must be defined by the user or as a product stream from another Process Block.

Unit Parameters

<u>Calculation Type</u>	<u>Specification Choices</u>
Adiabatic	P, and heat duty
Isothermal	P, T
Bubble Point	P or T
Dew Point	P or T
Vapor Target	P or T, Vapor Amount or V/F
Isochoric	P or T, Volume

All specifications of pressure can be made by specifying either a pressure loss across the Mixer unit or by specifying the exit stream pressure.

If the Parameter facility is not used, a zero pressure drop across the unit is assumed using the lowest inlet pressure, and the streams will be mixed adiabatically.

Unit Configuration

This facility allows the user to add or delete extra feed streams to the unit and is accessed via the Properties pane. An additional nine inlet streams may be defined if required.

Guidelines

When additional streams are to be added to the unit, the user must first ensure the minimum data requirements for the unit are specified prior to adding the streams.

2. Separator Unit

This is a process unit which allows up to 10 inlet streams to be separated into distinct physical phases. Outlet conditions, including suspended solids, entrained liquid, and entrained vapor concentrations, can be calculated.

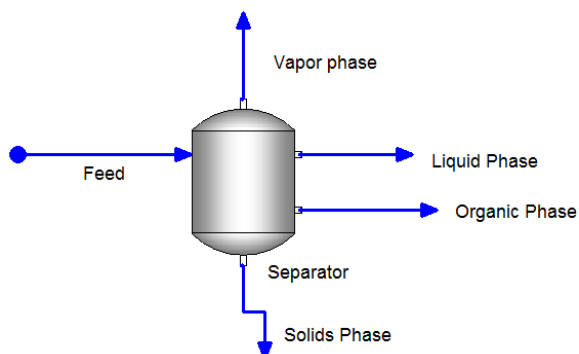

Data Requirements

A minimum of one feed and an aqueous exit stream must be defined. The feed stream must be defined by the user or be a product stream from another Process Block. Both streams must be named, and the inlet temperature, pressure, flow, and composition must be specified.

Units Parameters

Different Equilibrium Calculations are available:

- Adiabatic
- Isothermal
- Bubble Point
- Dew Point
- Vapor Target
- Isochoric

Concentration limits can be defined for phase distribution among the outlet streams and are achieved via the Entrainment option under the Equilibrium Calculation section.

These phase distributions include:

Distribution	Stream
Suspended solids	Liquid* outlet stream
Entrained liquid concentration	Vapor outlet stream
Entrained liquid	Solid outlet stream
Entrained vapor	Liquid* outlet stream
Entrained aqueous phase (Liquid1)	Organic outlet stream (Liquid 2)
Entrained organic phase (Liquid 2)	Aqueous outlet stream (Liquid 1)

* The liquid outlet is the combined aqueous and organic outlet streams.

The screenshot shows the 'Properties' window for 'Sep-1 Separator'. The 'Definition' tab is active. It contains three main sections: 'Suspended Solids', 'Entrained Liquid', and 'Entrained Phases'. Each section has a corresponding input field with a yellow highlight: 'Solids in Liquid (g/g)', 'Liquid in Vapor (g/g)', 'Liquid in Solid (g/g)', 'Vapor in Liquid (g/g)', 'Liquid1 in Liquid2 (g/g)', and 'Liquid2 in Liquid1 (g/g)'. There are also 'Back' and 'General' buttons at the top.

When the specified limits are exceeded for a particular phase distribution, the surplus quantity remains in its respective phase outlet stream.

Conversely, when one specified phase distribution requires all of the phase, the specification is satisfied, and that phase is eliminated. For example, if the amount specified for the dissolved vapor in the liquid is greater than the amount of vapor present, then all the vapor is put in the liquid outlet, and the vapor outlet is set to zero.

If two specified phase distributions cannot be met, the error condition is raised.

Unit Configuration

This facility allows the user to add or delete extra inlet streams to the unit and is accessed via the Properties Pane. An additional nine feeds may be defined if required.

Guidelines

When additional streams are to be added to the unit, the user must first ensure the minimum data requirements for the unit are specified prior to adding new inlet streams.

3. Neutralizer Unit

This is an environmental Process Block which allows up to 10 feed streams to be neutralized by the addition of a suitable reagent. The neutralization can be modeled adiabatically by mixing the inlet streams, by varying the neutralizing reagent flow to meet a fixed pH set point.

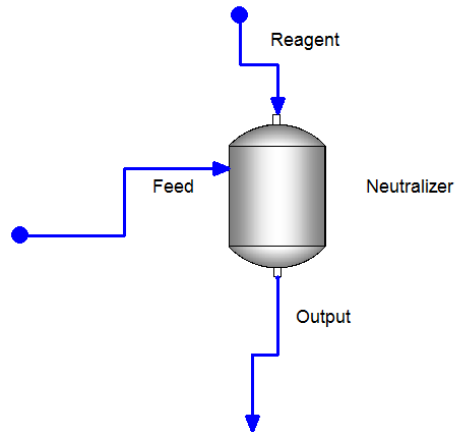

Data Requirements

A minimum of one feed stream and one neutralizing reagent stream must be named. In addition, temperature, pressure, total flow rate, and composition data of the feed stream(s) must be specified by the user or be a product stream from another process block. The user must supply the same information for the dosing stream. The dosing stream must be specified as the top entry stream to the process unit. The Process Block outlet stream must be named. Additionally, the process operating conditions must also be defined by the user.

Unit Parameters

The process mode of operation is defined by using the Properties Pane and selecting the Parameters facility. Two calculation options are currently available to allow the process to be modeled:

- Adiabatic mixing of the feed streams
- Setting pH of the outlet stream

If adiabatic mixing is chosen, the simulator determines the outlet stream properties based upon the user-specified inflows. However, if a fixed exit pH is required for the effluent, the simulator varies the reagent stream flow rate accordingly until the effluent pH requirement is obtained.

Specifications of pressure can also be made by specifying either a pressure loss across the unit or by specifying the exit stream pressure.

Neutrl-1 Neutralizer	
Definition	General
Inlets	
Feed	
Reagent	
Outlets	
Outlet	
Equilibrium Calculation	
Calculation Type	Fix pH
Pressure Spec.	Adiabatic
pH	Fix pH
Advanced Options	
Chemistry Model	Chemistry (Default)

Unit Configuration

This facility is accessed using the Properties Pane. An additional nine feeds may be defined if required.

Guidelines

When additional streams are to be added, the user must first ensure the minimum data requirements for the unit are specified prior to adding new feed streams.

The reagent stream must be a process entry stream. That is, the reagent stream cannot be a product from another process block or be a recycle stream.

A guess for the flow rate of the reagent stream is required.

Systems with difficult chemistry (i.e., multiple phases, multiple solids) may have problems in converging this Process Block. If the block does not converge, a Crystallizer can be alternately simulated by using a Mix, Manipulate, and Controller block.

Splitter Unit

4.1. Flow Split Unit

This is a conventional process unit that allows a single inlet to be divided into over 10 outlet streams, all with the same temperature, pressure, and relative species content.

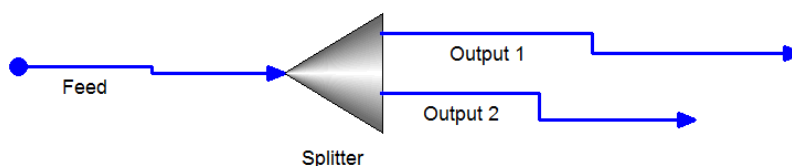

Data Requirement

The unit's stream inflow and exit flows must all be given distinct names, so that they can be linked to other process units, if required.

One feed stream, and a minimum of two exit streams must be defined by the user. The inlet stream temperature, pressure, flow, and composition data must be defined or be a product stream from another Process Block. Additionally, the split outlet stream fractions or flows must be defined.

Unit Parameters

Split-1 Splitter	
Definition	General
Inlets	
Feed	<input type="text"/>
Outlets	
Outlet	<input type="text"/>
Parameters	
Outlet Split	<input type="text"/> <input type="button" value="Edit"/>
Advanced Options	
Chemistry Model	<input type="text" value="Chemistry (Default)"/>

The stream outlet fractions are defined using the Action Key and then by selecting the Parameters facility (Edit). The outlet fractions may be defined on one of a variety of bases, (e.g., mole fractions, flow, etc.) which are then automatically normalized by the software such that the sum of the outlet fractions is equal to 1.

Enter the fraction of each outlet to the total or the flow.
Flows will be removed first from the total. The remaining fractions will be normalized.

Flow Basis: Moles Mass Volume

Outlet	Fraction	Flow (mol/hr)
S-2		
S-3		
S-4		

OK Cancel

Unit Configuration

This facility allows the user to add or delete extra outlet streams from the unit and is accessed via Properties Pane. An additional ten exit streams may be defined if required.

Guidelines

When additional streams are to be added, the user must first ensure the minimum data requirements for the unit are specified prior to adding streams.

4.2. Component Split Unit

This is a conventional process unit which allows over 10 inlet streams to be divided into two exit streams, one of which contains user-defined species component fractions.

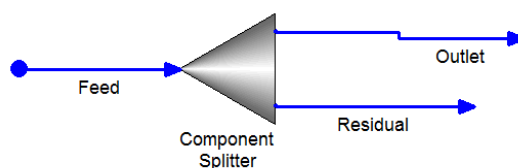

4.2.1. Data Requirement

A minimum of one feed stream and two exit streams must be defined. The inlet stream temperature, pressure, flow, and composition data must be defined by the user or as a product stream from another Process Block. The top exit stream from the unit is the stream for which the required species component fractions are specified.

4.2.2. Unit Parameters

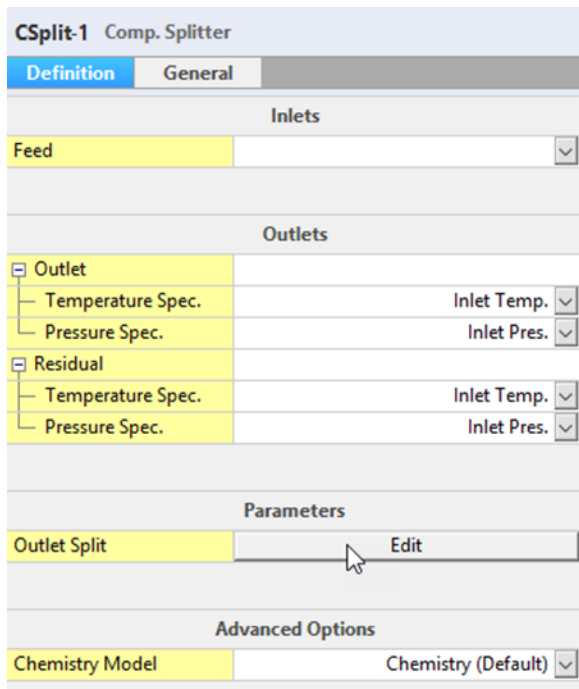

The stream outlet fractions are defined using the Action Key and then by selecting the Parameters facility (Edit). The species fractions may be specified on either a mole fraction or flow basis, (e.g., mole fractions, flow, etc.) which are then automatically normalized such that the sum of the exit species mole fractions is equal to 1.

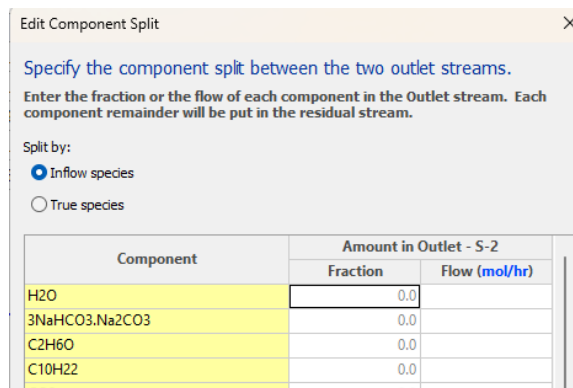

4.2.3. Unit Configuration

This facility allows the user to add or delete extra inlet streams to the unit and is accessed via the Properties Pane. An additional 10 feeds may be defined if required.

4.4.4. Guidelines

When additional streams are to be added, the user must first ensure the minimum data requirements for the unit are specified prior to adding new streams.

Absorber Unit

This is a multi-stage conventional or environmental process unit which allows species in a vapor feed to be absorbed by a counter-current liquid stream. The unit can hold up to a maximum of 50 stages and up to a maximum of 10 feed and 10 product streams.

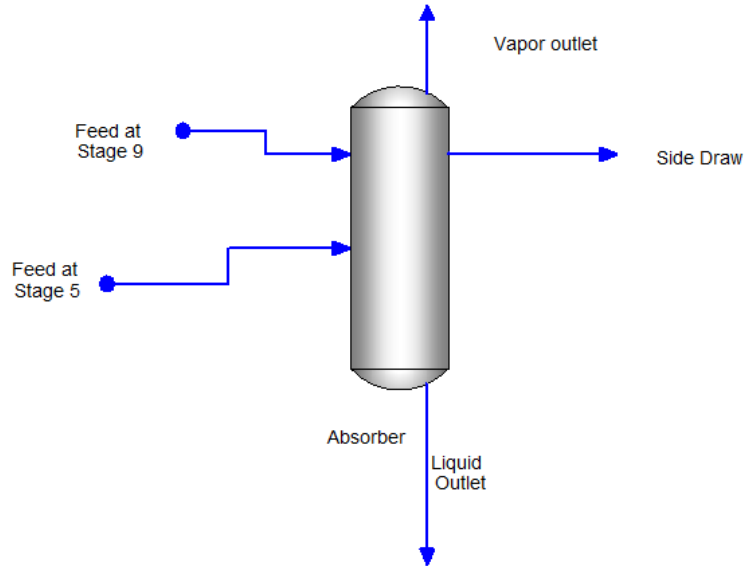

Data Requirement

A minimum of one liquid stream entering the top of the column and one vapor stream entering the bottom of the unit must be specified. The respective feed stream temperature, pressure, flow, and composition must be defined by the user or be a product stream from another Process Block.

When defining the feed stream, the temperature and pressures of each stream should be such that the species components reside in the correct phase for the respective stream.

The column exit vapor and liquid streams must be named, in addition to various column parameters.

Column Configuration

Column parameters can be defined via the Properties Pane. Seven options are available:

- **Calculation Method:**
 - Equilibrium
 - Mass Transfer Ltd.
- **Number of Stages:** The default number is 10 stages.
- **Include condenser/reboiler:** This option allows the user to delete or insert these respective units from/to the column. Initially, the Process Block does not include the two heat exchanger units.
- **Inlets:** This function is optional and allows the user to specify up to 8 additional feed streams to the column.
- **Outlets:** This function is optional and allows the user to specify up to 8 additional product streams from the column.
- **Pump-arounds:** This function is optional and allows the user to specify side stream pump-arounds if required. Pump-arounds must be from a lower to a higher stage of the column, and the flow rate must be defined.

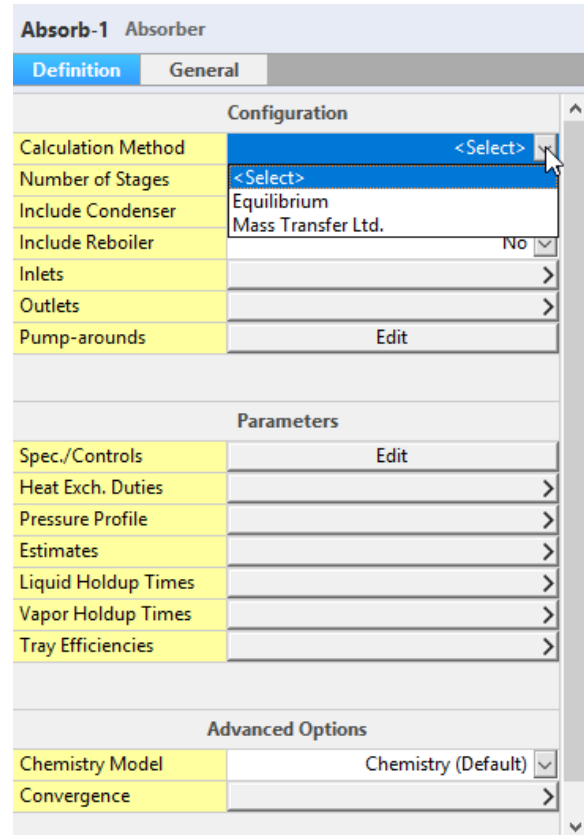

Column Parameters

The column operating parameters are accessed using Properties Pane. Eight options are available:

Spec/Controls: This function is optional and allows the user to manipulate parameters (e.g., heat exchanger duty) to meet specifications in the column operation. For example, vapor and/or liquid composition specifications, stage operating temperature, and vapor and/or liquid stream component flow rate specifications can all be achieved.

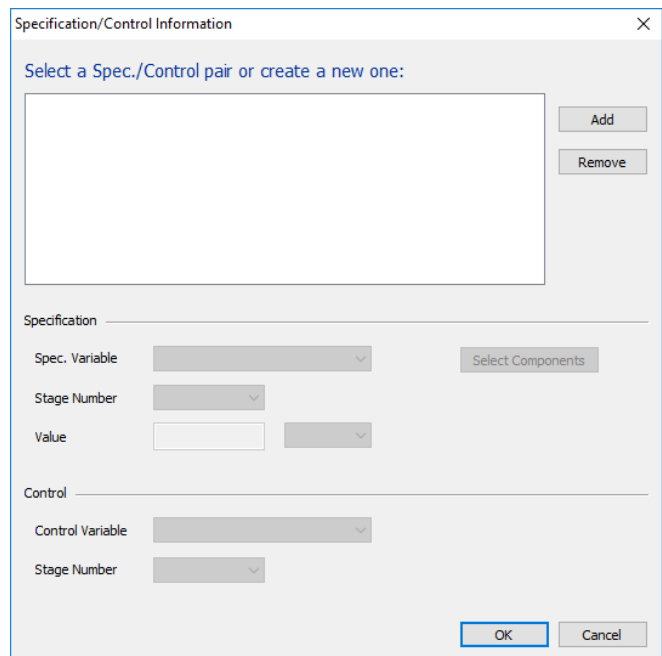

Heat Exchanger Duties: This option allows column heat exchanger duties to be specified. For columns using a condenser and/or reboiler, the user must define duties for the respective units.

< Back		Heat-exch. Duties Absorber	
Definition		General	
Heat-exch. Duties			
Stage		Value (cal/hr)	
	▼		

Pressure Profile: This option allows an accurate pressure profile to be specified. This is done by specifying top and bottom stage pressures, taking the reboiler and condenser into account. If only one stage pressure is given, a zero-pressure drop is assumed through the column.

< Back		Absorb-1 Absorber	
Definition		General	
Pressure Profile (atm)			
Stage 10 (Top)			
Stage 9			
Stage 1 (Bottom)			

Column Estimates: This option allows stage operating temperatures, vapor distillate, and liquid reflux flow estimates to be specified. The estimates for top and bottom stage temperature, as well as vapor distillate and liquid reflux flow rates, must all be specified by the user.

< Back		Absorb-1 Absorber	
Definition		General	
Temperature Estimates (°C)			
Stage 10 (Top)			
Stage 9			
Stage 1 (Bottom)			
Vapor Flow Estimate (mol/hr)			
Stage 10 (Top)			
Liquid Flow Estimate (mol/hr)			
Stage 10 (Top)			

Liquid/Vapor Hold-Up Volumes: This function is required for columns whose Chemistry Model contains rate-limited reactions. This facility allows the user to specify both liquid and vapor hold-up volumes for specific column stages.

< Back		Liquid Holdup Times Absorber	
Definition		General	
Liquid Holdup Times			
Stage		Value (hr)	
	▼		

Tray Efficiencies: This function is enabled when the calculation method chosen is Equilibrium. This function is optional and allows the user to specify Murphree efficiencies for the column stages. If no data is entered, the stage efficiency is assumed to be 1.0.

< Back

Definition General

Specify murphree efficiency for each stage
Enter efficiency as a fraction between 0 and 1.

Stage	Value
10 (Top)	1.0
9	1.0
8	1.0
7	1.0
6	1.0
5	1.0
4	1.0
3	1.0
2	1.0
1 (Bottom)	1.0

Mass Transfer: This function is enabled when the calculation method chosen is Mass Transfer Ltd. This option allows the user to specify vapor-liquid mass and heat transfer coefficients on each stage of the column. The coefficients are overall coefficients and apply to all components. The interfacial transfer area must also be specified. If the same coefficients are used throughout the column, the coefficient may be varied to meet a composition specification by means of the spec/control parameters.

< Back Absorb-1 Absorber

Definition General

Mass Transfer Column Type

Column Type Packed Column

Mass Transfer Parameters

Stage Height (cm)

Column Diameter (cm)

Packing Type Pall Ring

Packing Material Metal

Packing Size (mm) 50

Packing Characteristics (Billet & Schultes)

N (1/m ³)	6242.0
a (m ² /m ³)	112.6
e (m ³ /m ³)	0.951
Cs	2.725
Cfl	1.58
C2	0.784
Cp	0.763
Cl	1.192
Cv	0.41

Advanced

Advanced Parameters Edit

No. of Liq. Interface Film Segments 1

In the mass transfer parameters panel, the user also has the option for advanced parameters:

- Enter mass transfer coefficients for each stage.
- Enter heat transfer coefficient for each stage.
- Specification of transfer areas

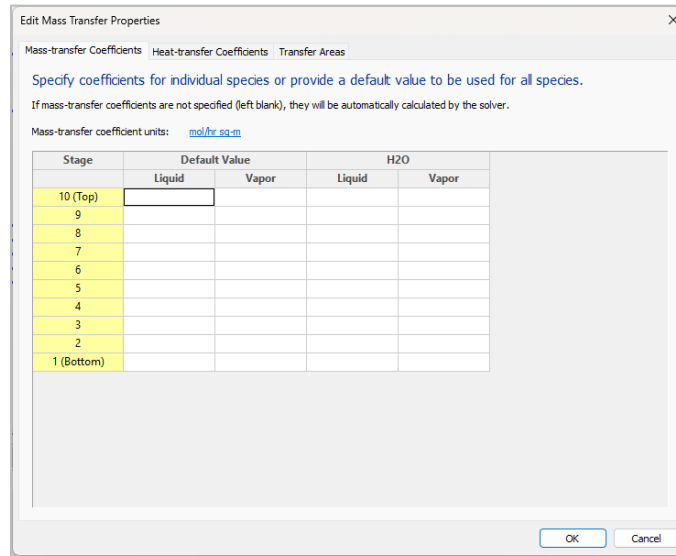

Guidelines

When defining column parameters, a zero-liquid reflux (i.e., distillate) rate should be defined. This is because the distillate flow exiting the unit must only exist in the vapor phase.

Distillation/Stripper Unit

This is a multi-stage unit allowing species in a liquid to be separated either by distillation or by the action of a counter-current vapor stream (i.e., stripper). The unit can hold a maximum of 50 stages, 10 feed streams, and 10 exit streams.

When this block is selected, the user can choose either an electrolyte column or a non-electrolyte column (if a non-electrolyte model was created). In the case of an electrolyte column, an aqueous phase must be present in every liquid stream. The liquid feed and/or liquid product can contain both an aqueous and non-aqueous liquid phase, or just an aqueous phase alone. In the case of a non-electrolyte column, only the non-electrolyte liquid phase exists (electrolyte chemistry is not considered).

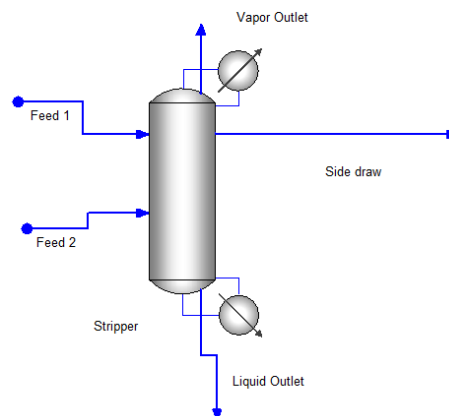

Data Requirement

A minimum of one feed stream and two exit streams (i.e., distillate and bottoms) must be named when using the unit for distillation. An additional feed must be added when using the unit as a stripper. The feed stream temperature, pressure, flow, and composition data must be specified by the user or be a product stream from another Process Block. The number of stages will default to 10 and appear that way on the

initial screen. The user may override this value. If there is a condenser or reboiler, these will count as stages. Additionally, various column operating parameter information must be supplied by the user.

Column Configuration

Additional column parameters can be defined, via configuration pane. Seven options are available:

- Calculation Method:**
 Equilibrium
 Mass Transfer Ltd.
- Number of Stages:** The default number is 10 stages.
- Include condenser/reboiler:** This option allows the user to delete or insert these respective units from/to the column. Initially, the process block includes the two units displayed.
- Inlets:** This function is optional and allows the user to specify up to 8 additional feed streams to the column.
- Outlets:** This function is optional and allows the user to specify up to 8 additional product streams from the column.
- Pump-arounds:** This function is optional and allows the user to specify side stream pump-arounds if required. Pump-arounds must be from a lower to a higher stage of the column, and the flow rate must be defined. See image below:

Column Parameters

The column operating parameters are accessed using the Action Key and then by selecting the parameters facility. Eight options are available:

Spec/Controls: This function is optional and allows the user to manipulate parameters (e.g., heat exchanger duty) to meet specifications in the column operation. For example, vapor and/or liquid

composition specifications, stage operating temperature, and vapor and/or liquid stream flowrate specifications can all be achieved.

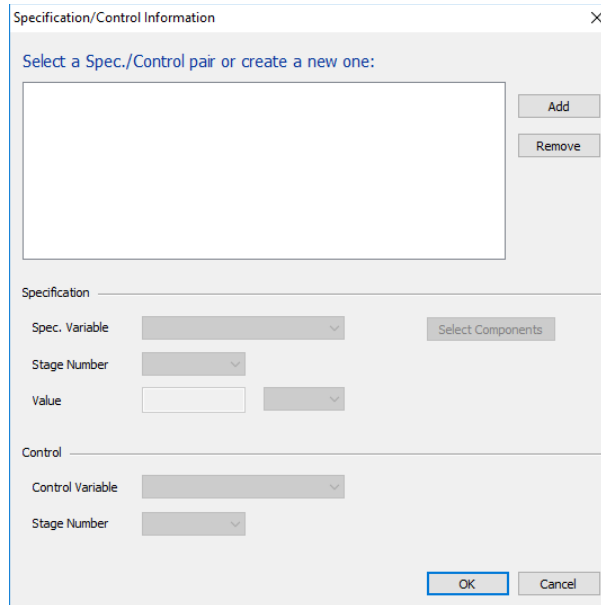

Specification/Control Information

Select a Spec./Control pair or create a new one:

Add

Remove

Specification

Spec. Variable

Stage Number

Value

Control

Control Variable

Stage Number

OK Cancel

Heat Exchanger Duties: This option allows column and pump-around heat exchanger duties to be specified. For columns using a condenser and/or reboiler, the user must define duties for the respective units. Negative heat duties imply heat removal.

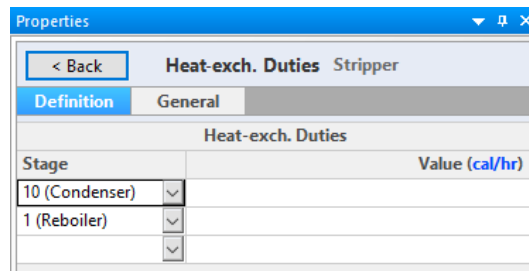

Properties

< Back Heat-exch. Duties Stripper

Definition General

Heat-exch. Duties

Stage	Value (cal/hr)
10 (Condenser)	
1 (Reboiler)	

Pressure Profile: This option allows an accurate pressure profile to be specified. This is done by specifying top and bottom stage pressures, taking the reboiler and condenser into account. If only one stage pressure is given, a zero-pressure drop through the column is assumed. If no values are given, the entire column is assumed to operate at atmospheric pressure.

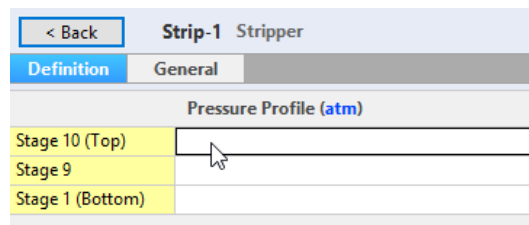

< Back Strip-1 Stripper

Definition General

Pressure Profile (atm)

Stage 10 (Top)	<input type="text"/>
Stage 9	
Stage 1 (Bottom)	

Estimates: This option allows stage operating temperatures, vapor distillate, and liquid reflux flow estimates to be specified. The estimates for top and bottom stage temperature, as well as the vapor distillate rate and liquid reflux flow rates, must all be specified by the user.

< Back **Strip-1 Stripper**

Definition General

Temperature Estimates (°C)

Stage 10 (Top)	
Stage 9	
Stage 1 (Bottom)	

Vapor Flow Estimate (mol/hr)

Stage 10 (Top)	
----------------	--

Liquid Flow Estimate (mol/hr)

Stage 10 (Top)	
----------------	--

Liquid/Vapor Hold-Up Volumes: This function is required for columns whose chemistry contains rate-limited reactions. This facility allows the user to specify both liquid and vapor hold-up volumes for specific column stages.

< Back **Liquid Holdup Times Stripper**

Definition General

Liquid Holdup Times

Stage	Value (hr)
<input type="text"/>	

Tray Efficiencies: This function is enabled when the calculation method chosen is Equilibrium. This function is optional and allows the user to specify Murphree efficiencies for the column stages and individual components. If no data is entered, the stage efficiency is assumed to be 1.0.

Tray Efficiencies

Specify murphree efficiencies for individual species or provide a default value to be used for all species.

Enter efficiency as a fraction between 0 and 1.

Stage	Default Value	H2O
10 (Top)	1.0	1.0
9	1.0	1.0
8	1.0	1.0
7	1.0	1.0
6	1.0	1.0
5	1.0	1.0
4	1.0	1.0
3	1.0	1.0
2	1.0	1.0
1 (Bottom)	1.0	1.0

- Mass Transfer:** This function is enabled when the calculation method chosen is Mass Transfer Ltd. This option allows the user to specify vapor-liquid mass and heat transfer coefficients on each stage of the column. The coefficients are overall coefficients and apply to all components. The interfacial transfer area must also be specified. If the same coefficients are used throughout the column, the coefficient may be varied to meet a composition specification by means of the spec/control parameters.

Strip-1 Stripper

Definition General

Mass Transfer Column Type

Column Type Packed Column

Mass Transfer Parameters

Stage Height (cm)

Column Diameter (cm)

Packing Type Pall Ring

Packing Material Metal

Packing Size (mm) 50

Packing Characteristics (Billet & Schultes)

N (1/m3)	6242.0
a (m2/m3)	112.6
e (m3/m3)	0.951
Cs	2.725
Cfl	1.58
C2	0.784
Cp	0.763
Cl	1.192
Cv	0.41

Advanced

Advanced Parameters Edit

No. of Liq. Interface Film Segments 1

In the mass transfer parameters panel, the user also has the option for advanced parameters:

- Enter mass transfer coefficients for each stage.
- Enter heat transfer coefficient for each stage.
- Specification of transfer areas

Edit Mass Transfer Properties

Mass-transfer Coefficients Heat-transfer Coefficients Transfer Areas

Specify coefficients for individual species or provide a default value to be used for all species.
If mass-transfer coefficients are not specified (left blank), they will be automatically calculated by the solver.

Mass-transfer coefficient units: mol/hr sq-m

Stage	Default Value		H2O	
	Liquid	Vapor	Liquid	Vapor
10 (Top)				
9				
8				
7				
6				
5				
4				
3				
2				
1 (Bottom)				

OK Cancel

- **Condenser:** This function is optional and allows the user to specify the type of condenser. If no data is entered, the condenser is assumed to be a partial condenser. Four types of condensers can be selected:
 - Partial Condenser
 - Total Condenser
 - Sub-cooled Total Condenser
 - Decanter

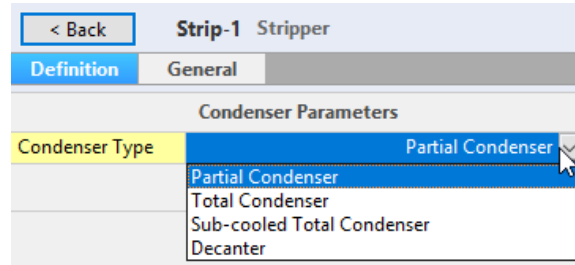

Guidelines

For columns with condenser and/or reboiler units, the heat duty estimates defined by the user must be such that a vapor flow exists on the bottom stage and a liquid phase flow exists on the top stage of the column, respectively.

The column can only operate if two (or optionally three) phases exist on every stage of the column.

For columns without a condenser and/or reboiler unit, a feed stream must be specified entering at the respective position of the omitted unit. The phase of this stream must be correctly defined. A liquid phase feed stream is required as an alternative to a column condenser, and a vapor phase stream in place of a reboiler unit (i.e., the column must have two phases flowing to and from every stage).

When defining a stripper unit, an all-liquid feed stream must be specified entering the top of the column, and the stripping vapor must enter the bottom of the unit.

When defining stripper column parameters, a zero-liquid reflux (i.e., distillate) flow must be made. This is because the distillate flow exiting the unit must only exist in the vapor phase.

All column stages are numbered from bottom to top.

If a feed stream contains both a vapor and a liquid phase, the liquid goes to the feed tray specified by the user and the vapor goes to the stage above.

Extractor Unit

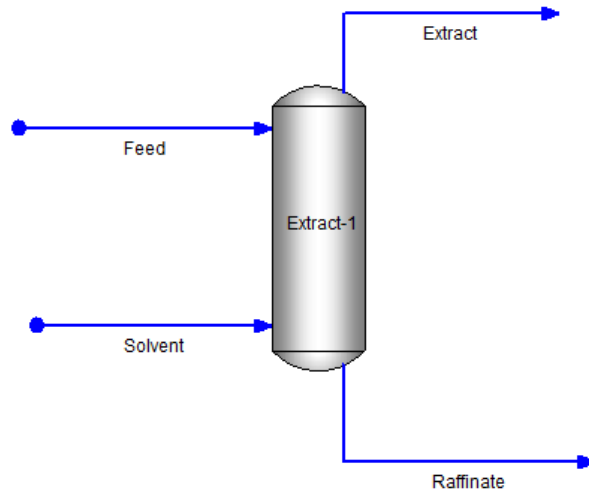

Data Requirement

A minimum of one aqueous feed stream must be defined entering the top of the column, and one solvent stream entering the bottom of the unit. The respective feed streams' temperatures, pressures, flows, and compositions must be specified, or be a product stream from another Process Block, and the unit outflows must be named. Additionally, various column operating parameter information must be specified by the user.

Column Configuration

Additional column parameters can be defined via the Action Key and selecting the Config facility. Five options are available:

- **Number of Stages:** The default number is 10 stages.
- **Inlets:** This function allows the user to specify up to 8 additional inlets to the column.
- **Outlets:** This function allows the user to specify a Second Liquid Outlet and Aqueous outlet from the column.

Extract-1 Extractor	
Definition	General
Configuration	
Number of Stages	10
Inlets	>
Outlets	>
Parameters	
Pressure Profile	>
Estimates	>
Tray Efficiencies	>
Advanced Options	
Chemistry Model	Chemistry (Default) ▾
Convergence	>

Column Parameters

The column operating parameters are accessed using the Action Key and selecting the Parameters facility. The options available are:

- **Pressure Profile:** This option allows an accurate pressure profile to be specified. This is done by specifying top and bottom stage pressures. If only one stage pressure is given, a zero-pressure drop is assumed through the column.

< Back		Extract-1 Extractor
Definition	General	
Pressure Profile (atm)		
Stage 10 (Top)		
Stage 9		
Stage 1 (Bottom)		

- **Column Estimates:** This option allows stage operating temperatures, organic distillate, and liquid flow estimates to be specified. The estimates for top and bottom stage temperatures, as well as organic distillate and liquid flow rates, must all be specified by the user.

< Back		Extract-1 Extractor
Definition	General	
Temperature Estimates (°C)		
Stage 10 (Top)		
Stage 9		
Stage 1 (Bottom)		
Vapor Flow Estimate (mol/hr)		
Stage 10 (Top)		
Liquid Flow Estimate (mol/hr)		
Stage 10 (Top)		

- **Tray efficiencies:** This option allows the user to enter the Murphree efficiency for each tray.

Tray Efficiencies		
Specify murphree efficiencies for individual species		
Enter efficiency as a fraction between 0 and 1.		
Stage	Default Value	H2O
10 (Top)	1.0	1.0
9	1.0	1.0
8	1.0	1.0
7	1.0	1.0
6	1.0	1.0
5	1.0	1.0
4	1.0	1.0
3	1.0	1.0
2	1.0	1.0
1 (Bottom)	1.0	1.0

Reactor Unit

This is a process unit that determines the phase separation and intra-phase speciation for a Chemistry Model, which can include both equilibrium and rate-limited reactions. The various types of phenomena that can be modeled include ion exchange, kinetics, and redox reactions.

The following types of reactors are available:

- Kinetics
- Stoichiometric Conversion
- Gibbs

Workout examples for each type of reactor can be found in Chapter 6, Section 6.1.

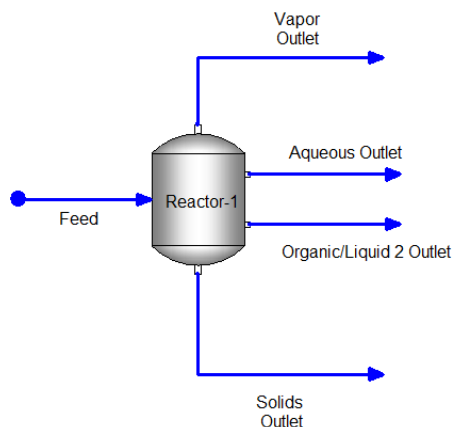

Data Requirement

A minimum of one feed stream entering the reactor must be named, along with the stream temperature, pressure, total flow rate, and composition data defined by the user or be a product stream from another Process Block. Also, the product stream(s) exiting the unit must be named. Additionally, the reactor operating parameters must be specified.

Reactor Configuration

Reactor parameters can be defined in the Reactor Properties pane. Three different reactor types can be selected, and this will define the additional parameters needed.

Reactor-1 Reactor	
Definition	General
Inlets	
Feed	Feed <input type="text"/>
Feed	<input type="text"/>
Outlets	
Outlet	Aqueous Outlet
Solids	Solids Outlet
Vapor	Vapor Outlet
Organic	Organic/Liq2 Outlet
Reactor Properties	
Reactor Type	<Select> <input type="text"/>
	<ul style="list-style-type: none"> <Select> Kinetics Stoichiometric Conversion Gibbs
Calculation Type	Adiabatic <input type="text"/>
Pressure Spec.	Min. Inlet Pressure <input type="text"/>
Heat Duty (J/hr)	0.0
Entrainment	<input type="text"/>
Advanced Options	
Chemistry Model	Chemistry (Default) <input type="text"/>
Properties	Watch

Kinetics Reactor

The chemical kinetics of the reaction are described by the Arrhenius Equation, which is specified in the Chemistry Model.

Reactor Properties

For the Kinetics reactor, you can specify kinetics parameters.

Reactor Properties	
Reactor Type	Kinetics <input type="text"/>
Kinetics Parameters	<input type="text"/>
Equilibrium Calculation	
Calculation Type	Adiabatic <input type="text"/>
Pressure Spec.	Min. Inlet Pressure <input type="text"/>
Heat Duty (J/hr)	0.0
Entrainment	<input type="text"/>

< Back **Kinetics Reactor** Reactor

Definition **General**

Specify kinetics parameters.
The kinetics reactor models a CSTR/PFR using kinetics reactions that are defined in the chemistry model.

Kinetics Parameters

Number of Stages

Residence Time (hr)

Kinetics Reactions in the Chemistry Model

C3H6(vap) + C6H6(vap) = C9H12(vap)

You can create/modify reactions from the chemistry model's 'Kinetics' tab.

Equilibrium Calculations

Several options are given in this panel:

Calculation Type: Can be Adiabatic or Isothermal

Pressure Spec.: Can be minimum inlet pressure, absolute pressure, or pressure drop.

Pressure Drop: Specify the pressure drop within the block.

Temperature: If the calculation is isothermal

Heat duty: If the calculation is adiabatic

Entrainment

Equilibrium Calculation

Calculation Type

Temperature (°C)

Pressure Spec.

Pressure Drop (atm)

Entrainment

These phase distributions include:

Distribution	Stream
Suspended solids	Liquid (combined aqueous and organic) outlet stream
Entrained liquid concentration	Vapor outlet stream
Entrained liquid	Solid outlet stream
Entrained vapor	Liquid* outlet stream
Entrained aqueous phase (Liquid1)	Organic outlet stream (Liquid 2)
Entrained organic phase (Liquid 2)	Aqueous outlet stream (Liquid 1)

Properties **Reactor-1** Reactor

Definition **Calculated** General

Suspended Solids

Solids in Liquid (g/g)

Entrained Liquid

Liquid in Vapor (g/g)

Entrained Phases

Liquid in Solid (g/g)

Vapor in Liquid (g/g)

Liquid1 in Liquid2 (g/g)

Liquid2 in Liquid1 (g/g)

Stoichiometric Conversion Reactor

Stoichiometric reactors use a simple stoichiometric relationship between reactants and products. There is no time factor for these reactions.

Reactor Properties

For the Conversion Reactor you can specify Reactions.

Equilibrium Calculations

Several options are given in this panel:

Calculation Type: Can be Adiabatic or Isothermal

Pressure Spec.: Can be minimum inlet pressure, absolute pressure, or pressure drop.

Pressure Drop: Specify the pressure drop within the block.

Temperature: If the calculation is isothermal

Heat duty: if the calculation is adiabatic

Entrainment

These phase distributions include:

Distribution	Stream
Suspended solids	Liquid (combined aqueous and organic) outlet stream
Entrained liquid concentration	Vapor outlet stream
Entrained liquid	Solid outlet stream
Entrained vapor	Liquid* outlet stream
Entrained aqueous phase (Liquid1)	Organic outlet stream (Liquid 2)
Entrained organic phase (Liquid 2)	Aqueous outlet stream (Liquid 1)

Gibbs Reactor

A Gibbs reactor is a special type of reaction in OLI Flowsheet: ESP in that it does not evaluate the standard equilibrium equations found in the Chemistry Model. Rather, it minimizes the Gibbs Free Energy at a given temperature and pressure or maximizes entropy at a given pressure and enthalpy. **It is important to point out that this reactor can be used only for reactions that occur in the vapor phase.**

Reactor Properties

For the Gibbs Reactor, you can specify Reacting Vapor Species.

Equilibrium Calculations

Several options are given in this panel:

Calculation Type: Can be Adiabatic or Isothermal

Pressure Spec.: Can be Min. inlet pressure, absolute pressure, and pressure drop.

Pressure Drop: Specify the pressure drop within the block.

Temperature: If the calculation is isothermal

Heat Duty: If the calculation is adiabatic

Outlet Temperature, Guess: Enabled for adiabatic calculations.

Entrainment

These phase distributions include:

Distribution	Stream
Suspended solids	Liquid (combined aqueous and organic) outlet stream
Entrained liquid concentration	Vapor outlet stream
Entrained liquid	Solid outlet stream
Entrained vapor	Liquid* outlet stream
Entrained aqueous phase (Liquid1)	Organic outlet stream (Liquid 2)
Entrained organic phase (Liquid 2)	Aqueous outlet stream (Liquid 1)

Filter Unit

This is a crystallization process unit which models the separation of the liquid portion of the feed stream from the solid portion of the feed stream. The liquid and solid are divided between the filtrate and filter cake (or solids) streams based upon specified fractions or flows.

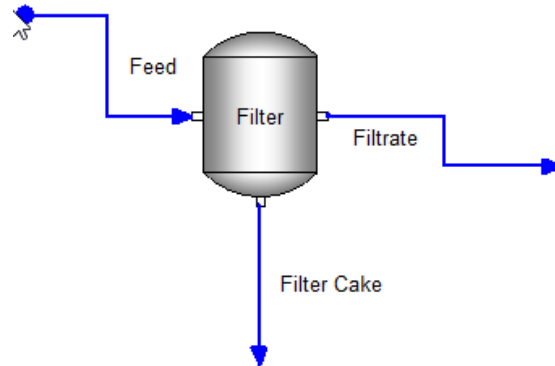

Data Requirement

One feed stream entering the Filter must be named, along with the stream temperature, pressure, total flowrate, and composition data defined by the user or be a product stream from another Process Block. Also, the outlet (filtrate and filter cake) streams exiting the unit must be named. The filter operating parameters must be specified.

Unit Parameters

The Filter operating conditions are specified using the Edit button.

Filter Filter	
Definition	General
Inlets	
Feed	Feed <input type="text"/>
Outlets	
Filtrate	Filtrate <input type="text"/>
Solids	Filter Cake <input type="text"/>
Parameters	
Outlet Split	<input type="text"/> <input type="button" value="Edit"/>
Advanced Options	
Chemistry Model	Chemistry (Default) <input type="text"/>

Two basic conditions must be specified:

- Split of the total liquid to the filtrate and solids streams, and
- Split of the solid between the filtrate and solids streams.

The total liquid may be split by using fractions or flows. Once one fraction is specified (e.g., the fraction of the total liquid split to the filtrate stream), the other is known and cannot be specified (e.g., the fraction of liquid split to the solids stream).

The total liquid may be split by specifying the flow of liquid in moles, mass, or volume to one of the outlet streams. Likewise, once one flow is specified, the other is known and cannot be specified.

The same procedure is followed when specifying the split of the solid to each of the outlet streams.

Edit Split
✕

Specify the flow split between the two outlet streams.

Enter the fraction of the total phase flow for each stream. Alternatively, enter the flow rate for one of the two streams.

Flow Basis: Moles Mass Volume

Liquid Split		Fraction	Flow (mol/hr)
Filtrate Stream - Filtrate		0.92	
Solids Stream - Filter Cake		0.08	

Solids Split		Fraction	Flow (mol/hr)
Filtrate Stream - Filtrate		1.0e-3	
Solids Stream - Filter Cake		0.999	

Guidelines

1. The only inlet stream allowed is the feed stream.
2. The entire liquid is split by fraction or flow to the two outlet streams: filtrate and solids.
3. The entire solid is split by fraction or flow. Individual solid species may not be selected. Thus, the makeup of the solid in the filtrate stream will be the same as the makeup of the solid in the solids stream.
4. Once the fraction or flow of liquid to the filtrate or solids stream is specified, the fraction or flow to the other stream is fixed and may not be specified. The same is true for the solid.

Settler Unit

This is a crystallization process unit which models the separation of the liquid portion of the feed stream from the solid portion of the feed stream. The liquid and solid are divided between the filtrate and solids outlet streams based upon specified fractions or flows. The solid may be split as a total solid or, differentially, split by individual solid species.

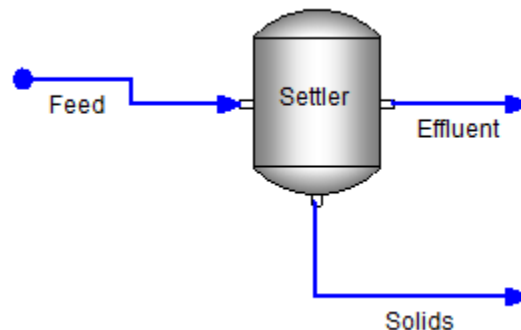

Data Requirement

One feed stream entering the Settler must be named, along with the stream temperature, pressure, total flowrate, and composition data defined by the user or be a product stream from another Process Block. Also, the outlet (effluent and solids) streams exiting the unit must be named. Additionally, the Settler operating parameters must be specified.

Unit Parameters

The Filter operating conditions are specified using the Edit Button.

Settler Settler	
Definition	General
Inlets	
Feed	Feed <input type="text"/>
Outlets	
Effluent	Effluent <input type="text"/>
Solids	Solids <input type="text"/>
Parameters	
Outlet Split	<input type="text"/> Edit
Advanced Options	
Chemistry Model	Chemistry (Default) <input type="text"/>

Two basic conditions must be specified:

- split of the total liquid to the filtrate and solids streams, and
- split of the solid, or individual solid species, between the filtrate and solids streams.

The total liquid may be split by using fractions or flows. Once one fraction is specified (e.g., the fraction of the total liquid split to the filtrate stream), the other is known and cannot be specified (e.g., the fraction of liquid split to the solids stream). The total liquid may be split by specifying the flow of liquid in moles, mass, or volume to one of the outlet streams. Likewise, once one flow is specified, the other is known and cannot be specified.

The Settler also offers the option to split specific solids from a solid stream.

The total solid may be split by using fractions or flows or the solid may be split by specifying the fraction or flow of specific solid species to each of the outlet streams. A combination of the two may also be used. That is, you may split one or more individual solid species by fraction or flow and then split the remainder of the solid by an overall fraction or flow. Since the solid may be split by individual solid species, the resulting solid portion of each of the outlet streams are not necessarily of the same makeup.

Specify the flow split between the two outlet streams.

To specify the overall split, enter the fraction of the total phase flow for each stream. Alternatively, enter the flow rate for one of the two streams.

You can override the flow split of specific solids going to the solids stream in the 'Specific Solids Split' tab.

Flow Basis: Moles Mass Volume

Liquid Split		Fraction	Flow (g/hr)
Effluent Stream - Effluent		0.8	
Solids Stream - Solids		0.2	

Solids Split		Fraction	Flow (g/hr)
Effluent Stream - Effluent		0.01	
Solids Stream - Solids		0.99	

OK Cancel

Specify the flow split between the two outlet streams.

To specify the overall split, enter the fraction of the total phase flow for each stream. Alternatively, enter the flow rate for one of the two streams.

You can override the flow split of specific solids going to the solids stream in the 'Specific Solids Split' tab.

Flow Basis: Moles Mass Volume

Component	Amount in Solids Stream - Solids	
	Fraction	Flow (g/hr)
Al(OH)2Cl	0.99	
Al(OH)3 (Gibbsite)	0.99	
Al2(OH)5Cl	0.99	
Al2(SO4)3 (Millosevichite)	0.99	
Al2(SO4)3.6H2O	0.99	
Al2(SO4)3.16H2O	0.99	
AlCl3.6H2O (Chloraluminite)	0.99	
AlO(OH) (Bohmite)	0.99	
AlOHC12	0.99	
Ca(OH)2 (Portlandite)	0.99	
CaCl2 (Hydrophilite)	0.99	
CaCl2.2H2O (Sinjarite)	0.99	
CaCl2.4H2O	0.99	

OK Cancel

Guidelines

The only inlet stream allowed is the feed stream.

The entire liquid is split by fraction or flow to the two outlet streams: filtrate and solids.

When splitting the solid, individual solid species may be selected. Any solid species not selected will be split using the overall solid split fraction or flow. Thus, the makeup of the solid in the filtrate stream will be the same as the makeup of the solid in the solids stream.

Once the fraction or flow of liquid to the filtrate or solids stream is specified, the fraction and flow to the other stream are fixed and may not be specified. The same is true for the solid.

Compressor Unit

This is a conventional Process Block which allows the compression of up to 10 feed streams into a single product stream. The compression can be carried out on either an isentropic or polytropic basis. The resulting phase separation and speciation within each phase is computed.

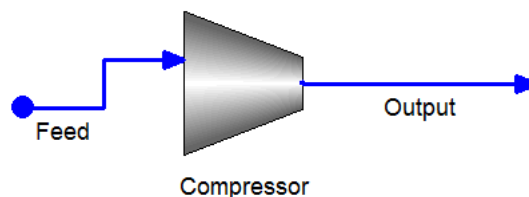

Data Requirement

The unit's stream inflows and exit flow must be given distinct names. This enables streams and units to be recognized and linked together when building a complex process. A minimum of one feed stream, together with its conditions, must be defined by the user or said stream must be a product stream from another Process Block.

Unit Parameters

The parameters available to define the compressor are as follows:

Parameter	Value	Comment
Compressor	Isentropic or polytropic	Must provide
Outlet Pressure	User	Must provide
Isentropic Efficiency	User (0.0 to 1.0)	Default = 0.72
Polytropic Efficiency	User (0.0 to 1.0)	Default = 0.72
Mechanical Efficiency	User (0.0 to 1.0)	Default = 1.0

Comp-1 Compressor

Definition | General

Inlets

Feed Feed

Feed

Outlets

Outlet Outlet

Parameters

Type Isentropic

Outlet Pressure (atm) 20.0

Isentropic Efficiency 0.75

Mechanical Efficiency 1.0

Advanced Options

Chemistry Model Chemistry (Default)

Unit Configuration

This unit allows the user to add or delete extra feed streams. An additional nine inlet streams may be defined if required.

Guidelines

When additional streams are to be added to the unit, the user must first ensure the minimum data requirements for the unit are specified prior to adding new streams.

Turbine Unit

This is a conventional Process Block which allows the expansion of up to 10 feed streams into a single product stream. The turbine block works on either an isentropic or polytropic basis. The resulting phase separation and speciation within each phase is computed.

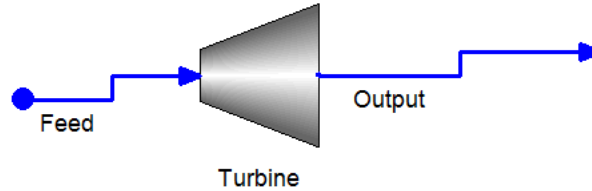

Data Requirement

The unit's stream inflows and exit flow must be given distinct names. This enables streams and units to be recognized and linked together when building a complex process. A minimum of one feed stream, together with its conditions, must be defined by the user or said stream must be a product stream from another Process Block.

Unit Parameters

The parameters available to define the compressor are as follows:

Parameter	Value	Comment
Turbine	Isentropic or polytropic	Must provide
Outlet Pressure	User	Must provide
Isentropic Efficiency	User (0.0 to 1.0)	Default = 0.72
Polytropic Efficiency	User (0.0 to 1.0)	Default = 0.72
Mechanical Efficiency	User (0.0 to 1.0)	Default = 1.0

Unit Configuration

This unit allows the user to add or delete extra feed streams. An additional nine inlet streams may be defined if desired.

Guidelines

When additional streams are to be added to the unit, the user must first ensure the minimum data requirements for the unit are specified prior to adding new streams.

Turbine-1 Turbine	
Definition	General
Inlets	
Feed	Feed <input type="text"/>
Feed	<input type="text"/>
Outlets	
Outlet	Outlet <input type="text"/>
Parameters	
Type	Isentropic <input type="text"/>
Outlet Pressure (atm)	1.0 <input type="text"/>
Isentropic Efficiency	0.72 <input type="text"/>
Mechanical Efficiency	1.0 <input type="text"/>
Advanced Options	
Chemistry Model	Chemistry (Default) <input type="text"/>

Heat Exchanger Unit

This is a conventional process unit which allows energy to be added to, or removed from, a single stream, or transferred between a process stream and a utility stream.

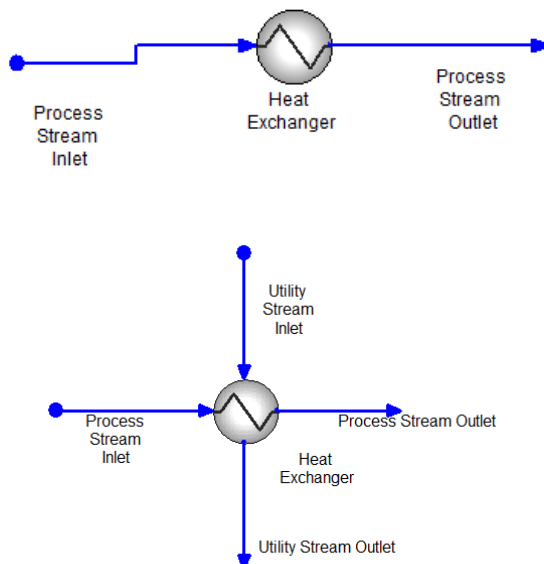

Data Requirement

A minimum of one inlet and corresponding exit stream must be named for the unit. Optionally, when simulating heat transfer between two streams, the utility inlet and outlet flows must also be identified. The inlet stream(s) temperature, pressure, flows, and composition data must also be defined by the user. Additionally, the unit operating conditions must be specified.

Unit Parameters

The unit operating conditions are specified in the definition panel.

Heat Exchanger Heat Exchanger	
Definition	General
Inlets	
Process Stream Inlet	Process Stream Inlet
Utility Stream Inlet	Utility Stream Inlet
Outlets	
Process Stream Outlet	Process Stream Outlet
Utility Stream Outlet	Utility Stream Outlet
Process Stream	
Spec. Type	Discharge Temperature
Discharge Temperature (°C)	
Pressure Spec.	Inlet Pressure
Utility Stream	
Spec. Type	Flow
Pressure Spec.	Inlet Pressure
Heat Exchanger	
Flow Geometry	Counter-current
Min. Temp. Approach (°C)	5.0
Advanced Options	
Chemistry Model	Chemistry (Default)

Six options are available for defining the Process Exit Stream requirements:

- Discharged Temperature
- Temperature Change
- Heat Duty
- Temperature Approach
- U*Area
- Vapor Fraction

Process Stream	
Spec. Type	Discharge Temperature
Discharge Temperature (°C)	Discharge Temperature
Pressure Spec.	Temperature Change
Pressure Drop (kPa)	Heat Duty
	Temperature Approach
	U*Area
	Vapor Fraction

For systems in which a utility stream is defined, the option is also available to specify:

- Flow rate
- Discharge Temperature
- Temperature Change

Utility Stream	
Spec. Type	Flow
Pressure Spec.	Flow
	Discharge Temperature
	Temperature Change

For definitions in which the utility stream exit temperature, or change in temperature, is specified, the utility stream flowrate is automatically modified. The initial user-defined value is changed in order to meet the required temperature operating requirements. Conversely, if the utility stream flowrate is defined its respective exit temperature is determined in order to comply with the process stream duty requirements.

The Heat Exchanger flow geometry can be either co-current or counter-current, and a minimum temperature approach can be specified.

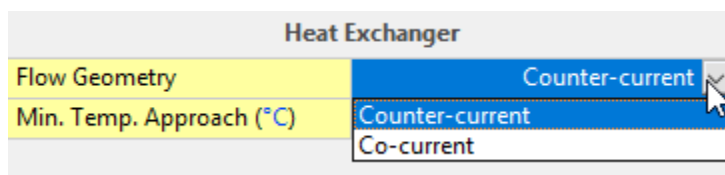

Guidelines

1. Additional inlet streams cannot be defined for this unit.
2. Process streams from other process units can be used as the utility stream if required. However, for this type of operation only the outlet temperature can be specified by the user.

Incinerator

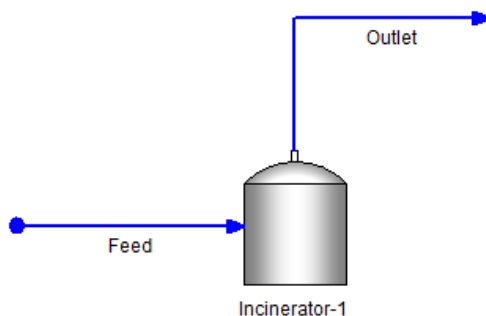

Data Requirement

A minimum of one feed stream to the unit must be defined, and its temperature, pressure, total flowrate, and composition data should be specified by the user or be the product stream from another Process Block. Note that the oxidation vapor stream composition (i.e., the air being used to burn the feed) must also be included as part of the feed stream(s) definition. The outlet (waste gas stream exiting the unit) must also be identified.

Unit Parameters

This unit can operate adiabatically or isothermally, one of which must be selected. For isothermal operation, the incinerator operating temperature must be supplied by the user.

Unit Configuration

This facility allows the user to add or delete extra inlet streams to the unit. An additional 9 feeds may be defined if desired.

Guidelines

When using this unit, the user must ensure a Non-Electrolyte Chemistry Model.

For clarification purposes, it is advised that the oxidation vapor stream is specified as a separate inlet flow to the unit, rather than as part of the feed stream composition.

Species that may form through a reduction/oxidation process and be in the outlet stream must be named as a species in the Chemistry Model (e.g., NO_x compounds, SO₂, etc.).

Incinerator-1 Incinerator	
Definition	General
Inlets	
Feed	Feed
Feed	S-1
Feed	S-2
Feed	S-3
Outlets	
Outlet	Outlet
Parameters	
Exit Temperatur...	300.0
Equilibrium Calculation	
Calculation Type	Isothermal
Pressure Spec.	Absolute Pressure
Pressure (atm)	1.0
Temperature (°C)	300.0
Advanced Options	
Chemistry Model	Chemistry (Default)

Feedback Controller

This is a Control Block which allows the user to specify a particular stream property by adjusting a block parameter of another Process Block.

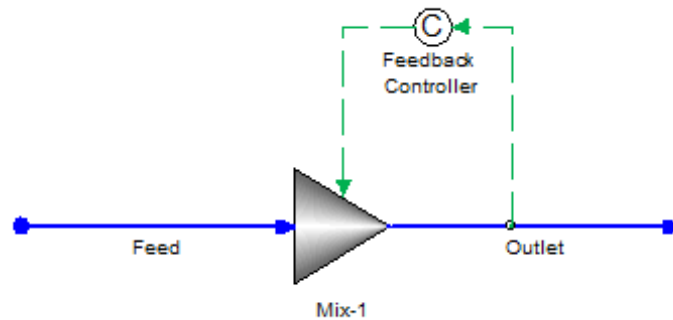

Data Requirement

The Controller definition can be divided into two parts: defining the stream specification and defining the block parameter of the Process Block to be varied to meet the stream specification.

Defining the Target Specification

The target stream is chosen from the streams already defined in another Process Block. Only streams which have been defined can be named in the Controller Block.

Feedback Controller	
Definition	General
Target Specification	
Target Stream	Outlet
Spec. Type	Flow
Basis	Volume
Phase	Aqueous Only
Target Value (L/hr)	1.0
Control Parameter	
Controlling Block	Water Valve
Block Parameter	Factor, Flow
Options	
Calculate After	<Automatic>
Convergence Options	>
<input type="checkbox"/> Disable this Controller	

The stream's specification type is then selected from a list, which include:

- Temperature
- Pressure
- pH

- Flow (When flow is selected as a specification, the phase and the units can be named)
- True species composition of the stream (when composition is selected as a specification, the phase and units of the composition can also be named)
- Material Balance Group Composition (the target composition can be named in terms of either the species in the solution (e.g., CaCO_3), or in terms of the material balance groups in the solution e.g., Ca (+2), C (+4), or O (-2)).
- Osmotic Pressure
- Oxidation Reduction Potential
- Fugacity (of single vapor species selected)
- Partial Pressure (of single vapor species selected)

Feedback-1 Feedback Controller	
Definition General	
Target Specification	
Target Stream	Process Stream Outlet
Spec. Type	Flow
Basis	Temperature
Phase	Pressure
Target Value (g/hr)	pH
	Flow
	True Species Composition
	Mat'l Balance Group Composition
	Osmotic Pressure
	Oxidation Reduction Potential
Control Object Type	Fugacity
Control Block	Partial Pressure
Parameter	

The Feedback Controller basis needs to be specified for Flow, True Species Composition, and MBG Composition. It can be either volume, mass, or moles. Different phases can also be specified:

Phase	Aqueous Only
Target Value (L/hr)	All phases
	Liquid (Aq + Organic)
	Vapor
	Solid
	Aqueous Only
Controlling Block	Organic Only
Block Parameter	Aqueous & Solid

Defining Control Parameter

The controlling block, which will be varied to meet the stream specification, is selected from a list of process blocks already defined. Once the controlling block is selected, the parameters available for that block are listed.

For example:

Control Parameter	
Controlling Block	Manipulator
Block Parameter	Factor, Flow
	Factor, Flow

Or

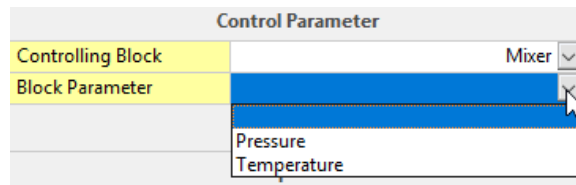

Unit Parameters

Controller parameters can be set which guide the convergence of the Controlling Block. These optional parameters are accessed in the Convergence Options.

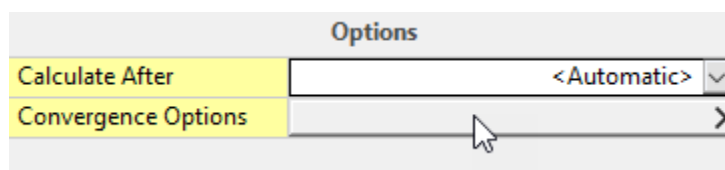

The parameters which can be set are:

Step Sized Method: Divided into three different methods. One of three calculation step size methods can be selected. The Slope Technique is the default.

Slope Technique: The slope between the last two guesses determines the next guess unless the step size minimum or maximum is exceeded. This is the fastest technique provided there are no large differences in slopes (as there are in titration curves or precipitation curves).

Half Interval: A new minimum or maximum is computed each iteration, and the new guess is based on $(\min + \max)/2$. This is a conservative technique, but a solution is assured for unimodal functions.

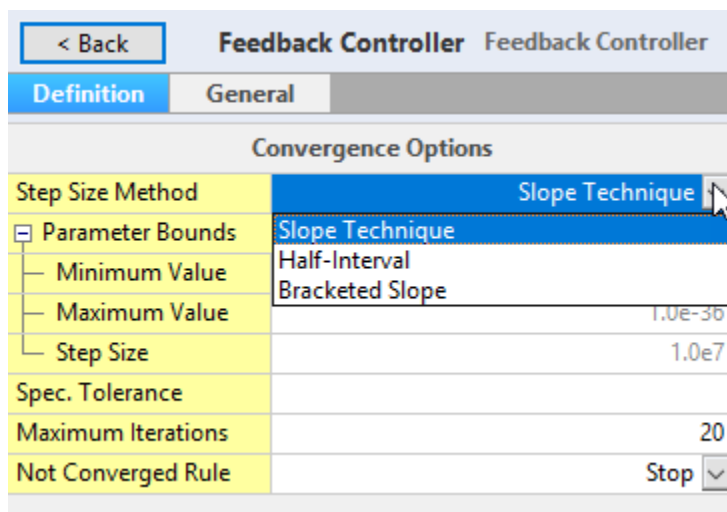

Bracketed Slope: As with the Half Interval technique, a new minimum and maximum is computed each iteration. The slope is then used to calculate the next guess, rather than $(\min + \max)/2$.

Parameter Bounds: The upper and lower limits of the process block parameter and the step size can be set. The default step size for the first iteration is 1%. The defaults for subsequent iterations are:

- 50% for general process variables
- 20 °C for temperature
- 25% for duty

Spec. Tolerance: Tolerance given by user.

Max Iterations: The number of iterations can be changed from the default of 20 iterations.

Not Converged Rule: The default "Continue" allows the program to continue the entire flowsheet calculation. The "Stop" terminates flowsheet calculation if the controller fails to converge.

Feed-forward Controller Unit

This is a Control Block which allows the measured value of a stream property or of a block parameter to be passed, or transferred, to a downstream block.

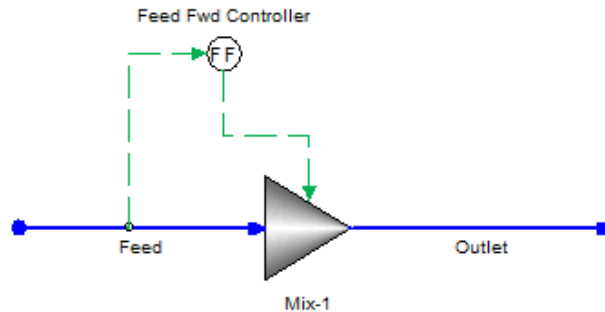

Data Requirement

The Feed-forward definition is divided into two parts: Controller Input and Controller Output.

The Controller Input defines the measured stream and measured property value that will be transferred. The Controller Output defines the downstream block or block parameter which will receive the value.

Feed Fwd-1 Feed-fwd Controller	
Definition	General
Controller Input	
Measured Stream	S-3
Measured Property	Pressure
Adjust Value by	Value + Constant
Constant (bar)	20.0
Controller Output	
Downstream Block	Pump
Block Parameter	Discharge Pressure, Specified
Adjust by	Replace value
Options	
Calculate After	<Automatic>
<input type="checkbox"/> Disable this Controller	

Defining the Controller Input (Transfer Value)

The Measured Property of the Measured Stream is chosen as the property to be transferred. The stream is chosen from those already defined in the process. The stream property is then selected from a list of possible names. For streams, this list includes temperature, pressure, pH, flow, composition of the stream (True Species Composition or Material Balance Group Composition), osmotic pressure, oxidation reduction potential, fugacity of a selected vapor species, or partial pressure of a selected vapor species.

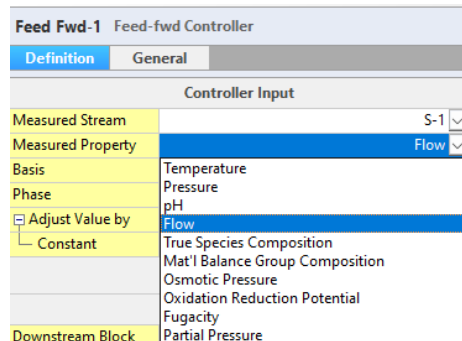

Finally, the value of the selected stream property can have an adjustment applied to it. Possible adjustments include:

- Value + Constant
- Value + Constant
- Value * Constant
- Value / Constant
- Constant / Value

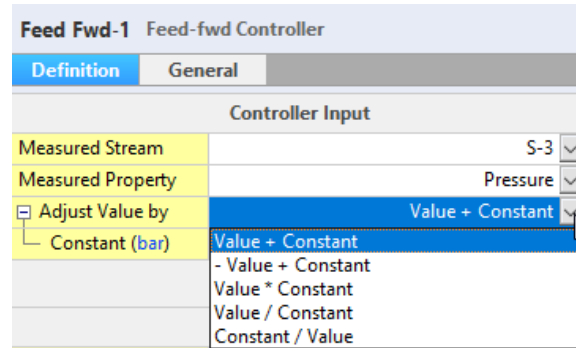

Defining the Controller Output (Block Parameter)

The Process Block parameter which will receive the transferred value is named as the Downstream Block. The Downstream Block is selected from a list of Process Blocks already defined.

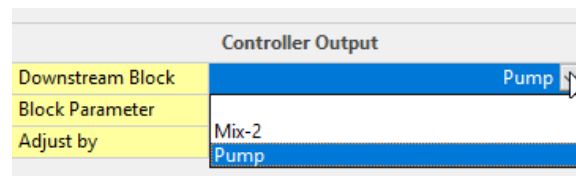

Once the Process Block is selected, the allowed parameters for that block are available.

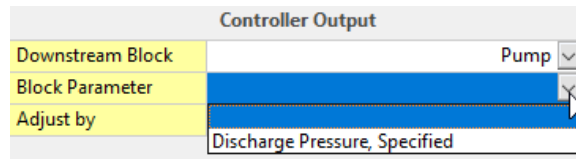

Finally, the value of the selected Block Parameter can have an adjustment applied to it. Possible adjustments include:

- Replace value
- Add to value
- Subtract from value
- Multiply times value
- Divide value

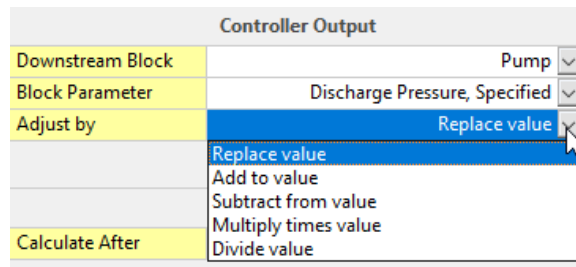

Guidelines

1. Avoid trying to control a variable which is discontinuous. For example, avoid trying to reach the saturation point of a solution with respect to a solid.
2. OLI Flowsheet: ESP allows for controlling and tearing the same stream.
3. The Feed-forward controller can be used to send its value to a Feedback controller's target value.

Manipulator Unit

This is a Control Block which allows the manipulation of the flow of a single inlet stream. Either the resulting flow or individual components can be multiplied by a factor. The resulting flow of the outlet stream is computed.

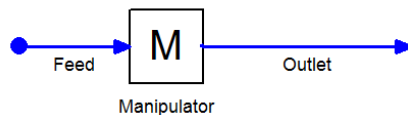

Data Requirement

The Feed and Outlet streams must all be given distinct names. This enables streams and units to be recognized and linked together when building a complex process. A single feed stream and its respective temperature, pressure, flow, and composition must be defined by the user.

Unit Parameters

The Properties pane allows the user to specify the factors by which either the Total Flow or Stream Component composition of the exit stream can be multiplied.

Guidelines

This block is generally used in conjunction with the other Control Blocks (e.g., Controllers) to adjust the flow of a feed stream or a composition in the stream.

Manipulator Manipulator	
Definition	General
Inlets	
Feed	Inlet
Outlets	
Outlet	Adjusted Inflow
Parameters	
Manipulation Type	Total Flow
Factor, Flow	Total Flow Stream Components
Advanced Options	
Chemistry Model	Chemistry (Default)

Direct Stream Manipulation

This feature allows the same functionality as a Manipulator Block. Either the resulting flow or individual components in a stream can be directly multiplied by a factor with the feedback controller. The resulting phase separation and speciation within each phase of the outlet stream is computed. Streams can also be connected to a feed-forward controller.

Data Requirement

1. For the stream: A minimum of one feed stream and their respective temperature, pressure, flow, and composition must be defined by the user
2. For the feedback controller: Target specification and control parameter must be selected.
3. For the feed-forward controller: The input and output parameters must be the same

Unit Parameters

1. For the feedback controller: The Properties pane allows the user to specify the factors by which either the Total Flow or Stream Component composition of the exit stream can be multiplied.

Feedback-1 Feedback Controller	
Definition	General
Target Specification	
Target Stream	Neutralized Mix
Spec. Type	pH
Target Value	9.0
Control Parameter	
Control Object Type	Stream
Control Stream	Caustic Reagent
Parameter	Factor, Total Flow
	Factor, Total Flow
	Flow Factor, (NH ₄) ₂ SO ₄
	Flow Factor, CO ₂
	Flow Factor, H ₂ O
	Flow Factor, H ₂ SO ₄
	Flow Factor, HCl
	Flow Factor, NH ₃
	Flow Factor, Na ₂ CO ₃
	Flow Factor, Na ₂ SO ₄
	Flow Factor, NaCl
	Flow Factor, NaHCO ₃
	Flow Factor, NaOH
	Flow Factor, SO ₂
Calculate After	
Convergence Options	
<input type="checkbox"/> Disable this Controller	

2. For the feed-forward controller:

Feed Fwd-1 Feed-fwd Controller	
Definition	General
Controller Input	
Measured Stream	Sepd Vap
Measured Property	Temperature
<input checked="" type="checkbox"/> Adjust Value by	Value + Constant
Constant (°C)	2.0
Controller Output	
Downstream Block	Mix-2
Block Parameter	Temperature
Adjust by	Replace value
Options	
Calculate After	<Automatic>
<input type="checkbox"/> Disable this Controller	

The Measured Property of the Measured Stream is chosen as the property to be transferred. The stream is chosen from those already defined in the process. The stream property is then selected from a list of possible names. For streams, this list includes temperature, pressure, pH, flow, or the composition of the

stream (True Species Composition and Material Balance Group Composition) along with additional parameters like Osmotic Pressure, Oxidation Reduction Potential, Fugacity, Partial Pressure.

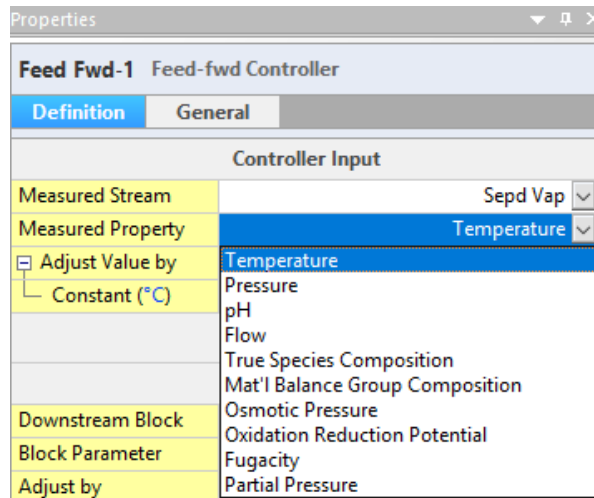

Finally, the value of the selected stream property can have an adjustment applied to it. Possible adjustments include:

- Value + Constant
- Value + Constant
- Value * Constant
- Value / Constant
- Constant / Value

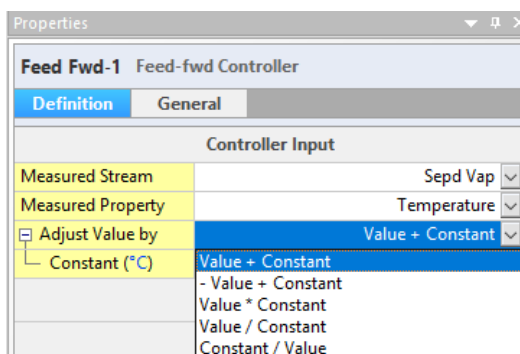

Defining the Controller Output (Block Parameter)

The process block parameter which will receive the transferred value is named as Downstream Block. The process block is selected from a list of process blocks already defined.

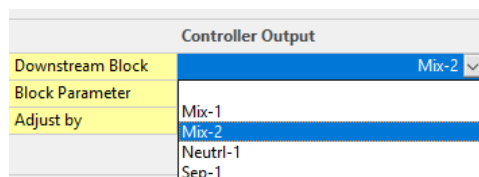

Once the process block is selected, the allowed parameters for that block are available. It is important to select the same input parameter as the output parameter for direct manipulation of streams. In this case we have selected temperature as the parameter to manipulate.

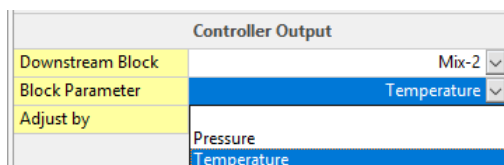

Finally, the value of the selected Block Parameter can have an adjustment applied to it. Possible adjustments include:

- Replace value
- Add to value
- Subtract from value
- Multiply times value
- Divide value

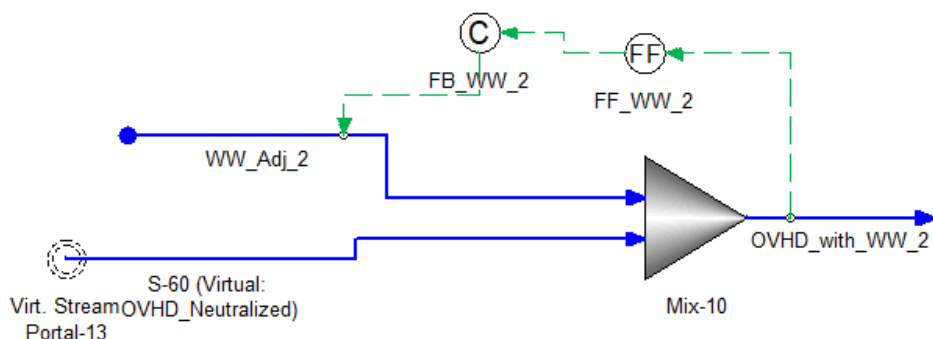
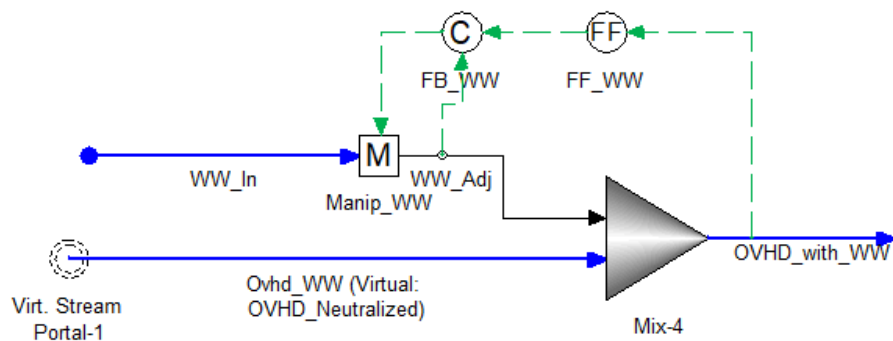
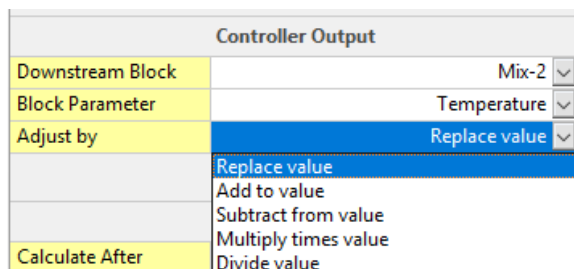

Guidelines

Users must first ensure the minimum data requirements for the stream are specified prior to connecting the stream to a controller.

This block is generally used in conjunction with the other Control Blocks (e.g., Controller) to adjust the flow of a stream or a composition in the stream or to feed/manipulate the values of downstream blocks.

Pump

This is a conventional process block which allows the change of the discharged pressure of 1 feed stream.

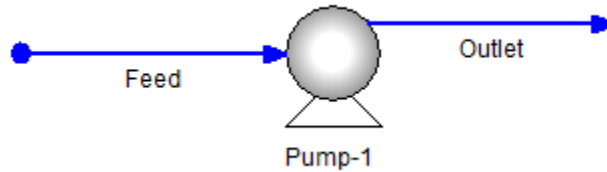

Data Requirement

The unit's stream inflow and exit flow must all be given distinct names. This enables streams and units to be recognized and linked together when building a complex process. The feed stream and their respective temperature, pressure, flow, and composition must be defined by the user.

Properties	
Pump-1 Pump	
Definition	General
Inlets	
Feed	Feed
Outlets	
Outlet	Outlet
Parameters	
Specification Type	Discharge Pressure
Inlet Area (sq-cm)	
NPSHR (cm)	
Motor Efficiency	0.9
Pump Efficiency	0.72
Static Head (cm)	
Discharge Pressure (bar)	20.0
Advanced Options	
Chemistry Model	Chemistry (Default)

Unit Parameters

The parameters available to define the pump are as follows:

Parameter	Value	Comment
Specification Type	Discharged Pressure or Pump Curve	Must provide
Inlet Area	User	Optional
NPSHR*	User	Optional
Motor Efficiency	User (0.0 to 1.0)	Default = 0.9
Pump Efficiency	User (0.0 to 1.0)	Default = 0.72
Static Head	User	Optional
Discharge Pressure	User	Must provide
Pump Curve	User	Must provide

*Net Positive Suction Head Required

To add a Pump Curve, go to Edit Button:

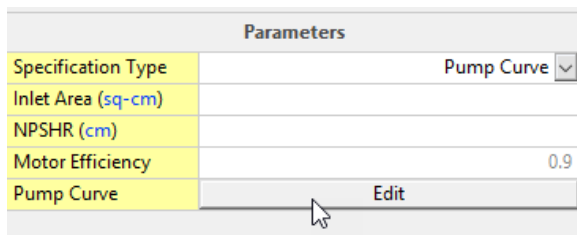

The screenshot shows a 'Parameters' dialog box with a table of parameters. The 'Pump Curve' parameter is highlighted in yellow, and its value is set to 'Pump Curve'. An 'Edit' button is visible next to the 'Pump Curve' parameter. Other parameters include 'Specification Type', 'Inlet Area (sq-cm)', 'NPSHR (cm)', and 'Motor Efficiency' (0.9).

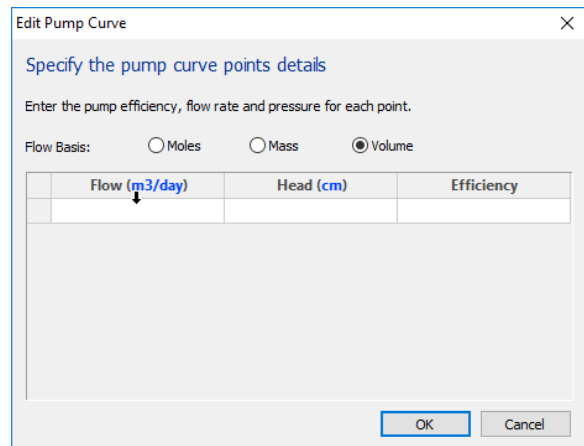

The screenshot shows the 'Edit Pump Curve' dialog box. It has a title bar 'Edit Pump Curve' and a close button. The main content is titled 'Specify the pump curve points details' and includes the instruction 'Enter the pump efficiency, flow rate and pressure for each point.' Below this, there are radio buttons for 'Flow Basis': Moles, Mass, and Volume (selected). A table is provided for entering data with columns for 'Flow (m3/day)', 'Head (cm)', and 'Efficiency'. The 'Flow' column has a mouse cursor pointing to it. At the bottom, there are 'OK' and 'Cancel' buttons.

RO Membranes (Reverse Osmosis)

This is a process block which allows for the separation of salts from a single process feed stream using a semi-permeable membrane. As a result of this separation, two product streams result: one called the "concentrate stream" and the other called the "permeate stream." The specification of a permeate inlet stream is optional.

Data Requirement

The unit's stream inflow and exit flows must be given distinct names. This enables streams and units to be recognized and linked together when building a complex process. A minimum of one conventional feed stream and one additional, optional permeate feed stream, together with their conditions, must be defined by the user or said stream must be a product stream from another Process Block.

Unit Parameters

The parameters available in the Properties Panel are divided into the following:

- Inlets and Outlets
- Membrane Element Performance Data
- Operation Parameters
- pH Control (Optional)
- Advanced Options

The screenshot shows the 'Properties' window for 'RO-1 RO Membrane'. The 'General' tab is active. The 'Operational Parameters' section includes:

Permeate Pressure (kPa)	101.325
Specify one of the following. If overall permeate recovery is specified, the total no. of vessels is calculated automatically. Feed flow is divided equally among the total no. of vessels.	
<input type="radio"/> Total No. of Vessels	1
<input checked="" type="radio"/> Overall Permeate Recovery (vol %)	80.0
No. of Elements per Vessel	1
Fouling Factor	
Pressure Drop per Element (kPa)	

The 'Advanced Options' section includes:

Control Electroneutrality by	Adjusting Cations
Chemistry Model	Chemistry (Default)

Inlets and Outlets: Clicking the inlets and outlets button, it will bring a new pane where the connections in and out of the RO block can be modified.

The screenshot shows the 'Properties' window for 'RO-1 RO Membrane' with the 'Inlets and Outlets' configuration pane open. The 'Inlets' section has a 'Feed' dropdown menu set to 'Feed'. The 'Outlets' section has two rows: 'Permeate' and 'Concentrate', both with dropdown menus set to their respective names.

Membrane Element Performance Data: Clicking on the Membrane Element Performance Data button will bring a new pane where you can input the following information:

< Back RO-1 RO Membrane

Definition General

Membrane Element Performance Data
Specify performance data under test conditions.

Performance Data Type	Manufacturer Data Sheet
Select Membrane	Select...
Manufacturer / Model	Hydranautics / SWC4 Max
Active Area (sq-cm)	4.09e5
Permeate Flow (L/hr)	1137.5
Permeate Recovery (vol %)	10.0
Temperature (°C)	25.0
Applied Pressure (atm)	54.2808

Salt Concentrations and Rejections

Component	Concentration mg/L	Rejection %
NaCl	32000.0	99.8
<Select>		

Manufacturer data retrieved on 3/10/2018 - [Source URL](#).

Membrane Model Library

Add Specified Data to Library Add...

In this option, you can select either Manufacturer Data Sheet or Lab analysis. When Manufacturer Data Sheet is selected the user needs to specify the Manufacturer and the Model of the membrane. Different options for manufacturer and model will be displayed. Additionally, active area, permeate flow, permeate recovery, temperature, and applied pressure values must be provided.

Performance Data Type	Manufacturer Data Sheet
Manufacturer	Manufacturer Data Sheet
Model	Lab Analysis

Salt Concentration and Rejections: The user has the option to select specific salts and define their concentration and rejection percentage.

Salt Concentrations and Rejections		
Component	Concentration kg/m3	Rejection %
NaCl	1.5	99.4
<Select>		

Membrane Model Library: This option allows the user to save the specified data to Library.

Note: If the user has selected the Manufacturer Option, the test rejection components will have species selection as a Molecular format. On the other hand, if the user selects the Lab Analysis Option, the salt concentration and rejection components will have species selection as Ionic format.

For the “Manufacturer” option, the “Salt Concentrations and Rejections” section requires at least one molecular test species entry. On the contrary, the “Lab Analysis” option “Salt Concentrations and Rejections” section requires at least one cation test species and one anion test species entry.

< Back RO-1 RO Membrane

Definition General

Membrane Element Performance Data

Specify performance data under test conditions.

Performance Data Type	Manufacturer Data Sheet
Manufacturer	Hydranautics
Model	ESPA1
Active Area (sq-ft)	399.331
Permeate Flow (gal/hr)	499.722
Permeate Recovery (vol %)	15.0
Temperature (°C)	25.0
Applied Pressure (kPa)	1050.0

Salt Concentrations and Rejections

Component	Concentration kg/m3	Rejection %
NaCl	1.5	99.4
KCl		
<Select>		
<Select>		

7/13/2017 - Source URL.

Model Library

Add...

- NaCl
- KCl
- <Select>
- H2O
- NaCl
- As2O3
- CaO
- KCl
- KF
- MgO
- N2O5
- SO3
- K2O
- MoO3
- NaBr
- NiO

< Back RO-1 RO Membrane

Definition General

Membrane Element Performance Data

Specify performance data under test conditions.

Performance Data Type	Lab Analysis
Active Area (sq-ft)	399.331
Permeate Flow (gal/hr)	499.722
Permeate Recovery (vol %)	15.0
Temperature (°C)	25.0
Applied Pressure (kPa)	1050.0

Salt Concentrations and Rejections

Component	Concentration kg/m3	Rejection %
Cl-1	1.5	99.4
Na+1		
H+1		
<Select>		
<Select>		

- AsO+1
- AsO2-1
- AsO3-3
- Br-1
- Ca(NO3)+1
- Ca+2
- CaCl2
- CaCl+1
- CaF+1
- CaOH+1
- CaSO4
- Cl-1
- F-1
- H+1
- H2O
- H2SO4
- HAsO2
- HAsO3-2

Operational Parameters

The following parameters need to be defined:

- Permeate Pressure
- Total Number of Vessels
- Overall Permeate Recovery (vol %)
- Fouling Factor
- Pressure Drop per Element

Note: Definitions of these different operation parameters can be found in the Appendix.

A more detailed description of the parameters needed in the Operational Parameters is given below:

Operational Parameters	
Permeate Pressure (kPa)	101.325
Specify one of the following. If overall permeate recovery is specified, the total no. of vessels is calculated automatically. Feed flow is divided equally among the total no. of vessels.	
<input type="radio"/> Total No. of Vessels	1
<input checked="" type="radio"/> Overall Permeate Recovery (vol %)	80.0
No. of Elements per Vessel	1
Fouling Factor	
Pressure Drop per Element (kPa)	

Permeate Pressure: This calculates the pressure differential across membrane (e.g., difference between the feed pressure and permeate pressure). Pressure differential needs to overcome the osmotic pressure differential of your feed for reverse osmosis to take place.

Total Number of Vessels: When the number of total vessels is given, the overall permeate recovery is calculated automatically.

Overall Permeate Recovery: When the overall permeate recovery is given, the total number of vessels is calculated automatically.

Number of Elements per vessel: Number of elements is by default 1; however, it could be maximum 5. This subdivides the total area of the membrane assembly by the elements entered and calculates each subdivision (or mini-membrane block or element) individually. However, it is important to note that in this option (if your number of elements is greater than 1), the permeates are collected in the common permeate duct after each element, and the residue or concentrated stream from mini-membrane block 1 (or element 1) will be fed to the feed side of the mini-membrane block 2 (or element 2) and so on.

Fouling Factor: Optional. Generally, manufacturers provide the value to the customer in their product sheet.

Pressure Drop per element: Feed side pressure may reduce during operation resulting in a decrease of the hydraulic pressure difference across membrane. Thus, the feed pressure of the 2nd element (e.g., residue pressure of 1st element) may decrease. Users can specify the pressure drop per element. In the absence of the user specified value, software will calculate the pressure drop.

pH control (Optional): This option is turned off by default. If the user wants to operate the RO Membrane at a given pH, it can be done with this option. Generally, membrane manufacturers recommend the pH for specific membranes. For example, a pH 4.5-11.0 may be reasonable for some membranes.

RO-1 RO Membrane

Definition | General

Inlets and Outlets >

Membrane Element Performance Data >

Operational Parameters

Permeate Pressure (kPa) 101.325

Specify one of the following.
If overall permeate recovery is specified, the total no. of vessels is calculated automatically.
Feed flow is divided equally among the total no. of vessels.

Total No. of Vessels 1

Overall Permeate Recovery (vol %) 80.0

No. of Elements per Vessel 1

Fouling Factor

Pressure Drop per Element (kPa)

pH Control (Optional) >

Advanced Options

Control Electroneutrality by Adjusting Cations

Chemistry Model Chemistry (Default)

Clicking on the pH Control (optional) button, the user can specify the target pH and the acid & base titrants needed to reach the target pH.

Properties RO-1 RO Membrane

< Back

Definition | General

pH Control (Optional)

Target pH

Acid Titrant <Not Specified>

Base Titrant <Not Specified>

Advanced Options: Under advanced options, the user can control the electroneutrality by adjusting either cation or anions. By default, the software adjusts cations.

Advanced Options

Control Electroneutrality by Adjusting Cations

Chemistry Model Adjusting Cations

Adjusting Anions

Guidelines

1. The membrane test methods or specifications are a set of test conditions previously known to membrane users. They would either have this data provided to them by the manufacturer or through lab analysis. These set of test conditions are the conditions at which the membranes are tested. They include temperature, applied pressure, unit permeate flow rate, recovery vol%, and unit active area for the membrane to be used.
2. The next set of values that the user must provide are test rejections. These involve the inflow concentration of the species and their manufacturer-provided rejection rate.
3. The user can specify the desired operational specifications for the membrane they want to simulate, such as permeate pressure and permeate recovery. The user also needs to configure the membrane with a specific number of elements/vessel and a total number of vessels. Number of elements per vessel is a fixed number. Currently, the maximum number of elements is set at 5.
4. It is up to the user to configure the vessel and element numbers and input it into the software; however, the software can calculate that number if it is not provided. In that case, the user must provide the

permeate recovery volume. After all these conditions are met, the user can simulate the block to view the block report which contains calculated number of vessels, total membrane area, total water flux along with membrane solute permeabilities and rejection rates in fractions.

Virtual Stream Portal

Data Requirement

The Virtual Stream Portal allows for a stream to be “Live-copied” to another stream. Live-copied means that the exact parameters of a stream are copied to another stream. If the original stream parameters are updated (either by the user or by the software) then the live-copied stream is also updated.

This differs from a direct-copied stream where the copy takes place only once. In a direct-copied stream, if the original stream is updated, the copied stream is not updated.

To use the Virtual Stream Portal, a stream must already be defined in the flowsheet.

Unit Parameters

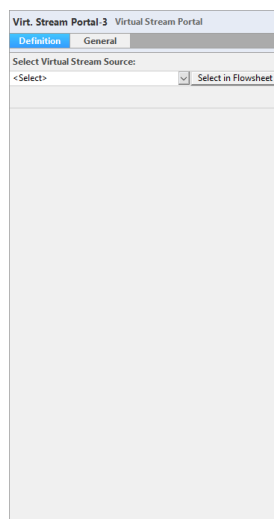
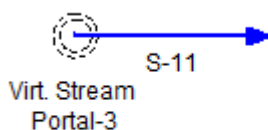

The Virtual Stream Portal has only two inputs. The user can select from a drop-down list of existing stream or select one by clicking the flowsheet diagram.

In this example we have a very simple process.

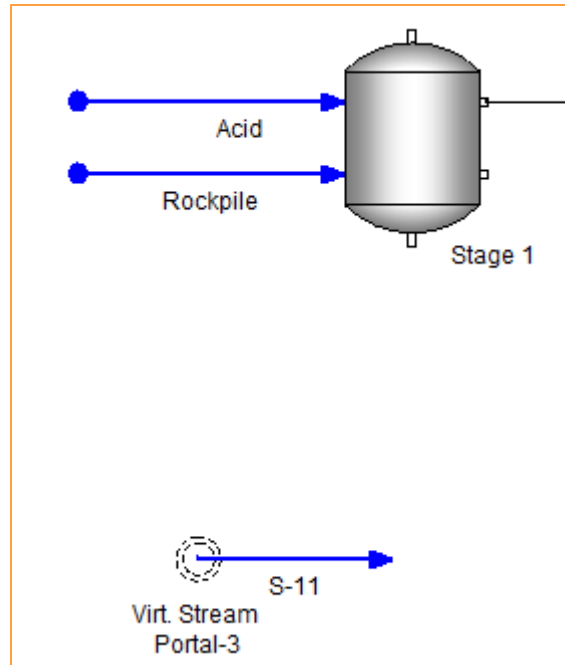

The Virtual Stream Portal can specify the stream by selecting it via the drop-down box.

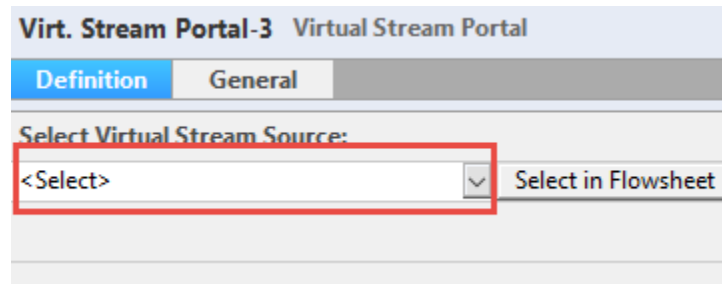

Click the drop-down box and select a stream from the list. Here we are selecting the stream "Acid."

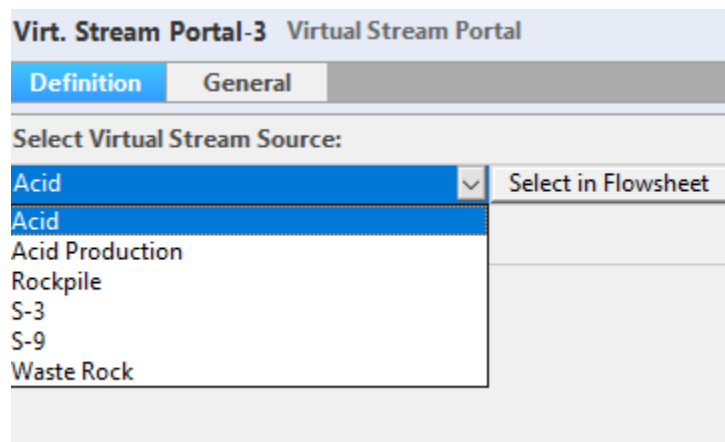

This updated the flowsheet diagram:

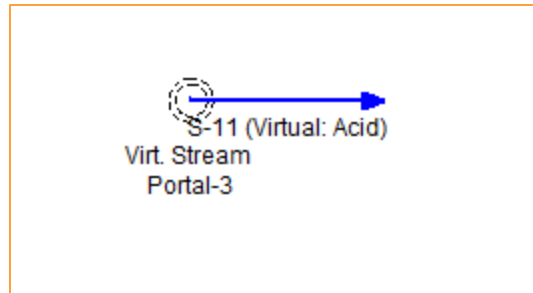

This is now a live copy of the original stream “Acid.”

You can also use the diagram to select a virtual stream:

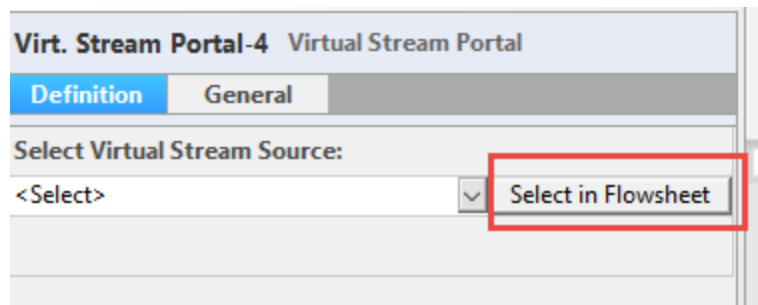

Click the button then click on the desired stream in the flowsheet diagram:

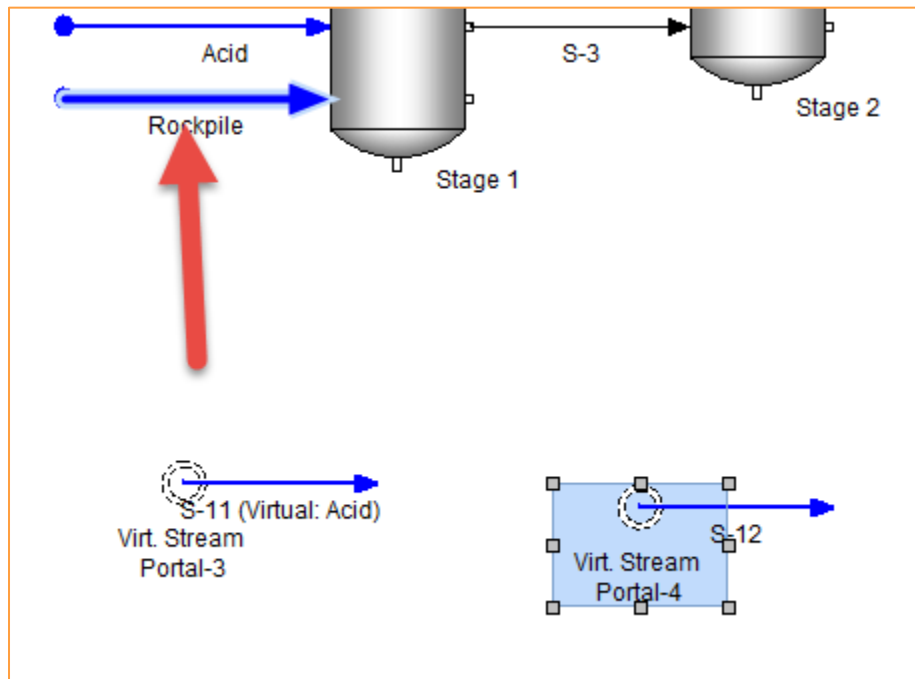

The selected stream is darkened to show that it is selected.

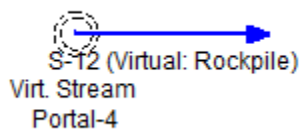

Virt. Stream Portal-4 Virtual Stream Portal	
Definition	General
Select Virtual Stream Source:	
Rockpile	Select in Flowsheet

Calculator

This is a control Block which allows the user to create their own custom calculation.

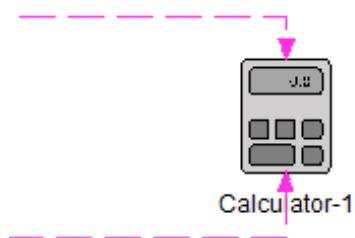

The Edit button opens up the "Define Custom Property and Values" dialog where the user can do the following:

- add or remove a custom property
- specify the expression (write the equation)
- define the properties or subexpressions used for the expression or equation

Calculator-1 Calculator	
Definition	General
Calculation	
Expression	Edit
Options	<Automatic> ▾
Variable Forwarding Specification	
Target Block	<None> ▾
Property	RH ▾
Display Options	
Show incoming connections	Yes ▾
Show outgoing connections	Yes ▾
<input type="checkbox"/> Disable this Calculator	

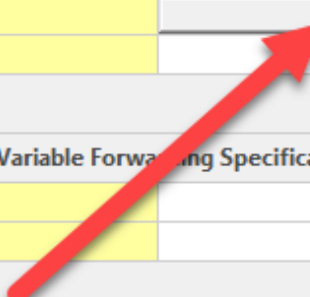

The "..." button opens the "Select a Property" screen where the user can select a stream or block property.

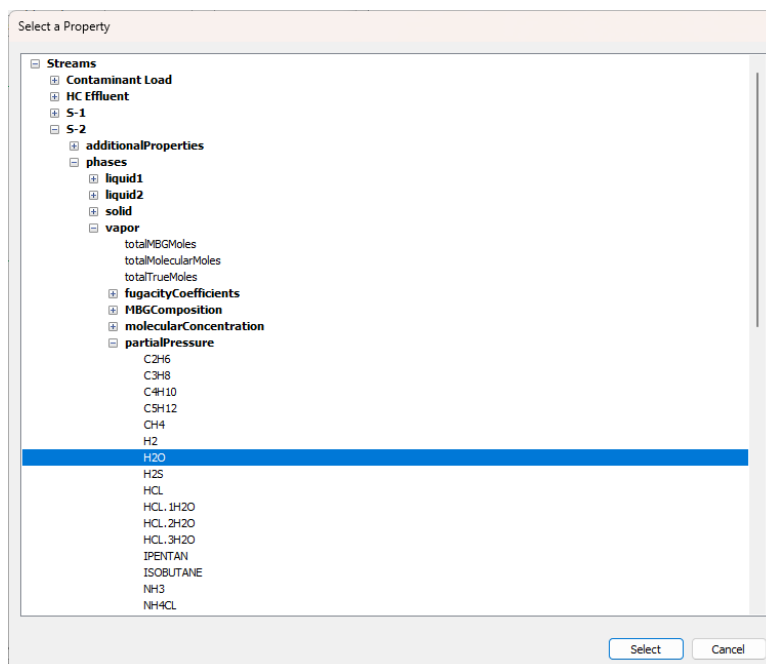
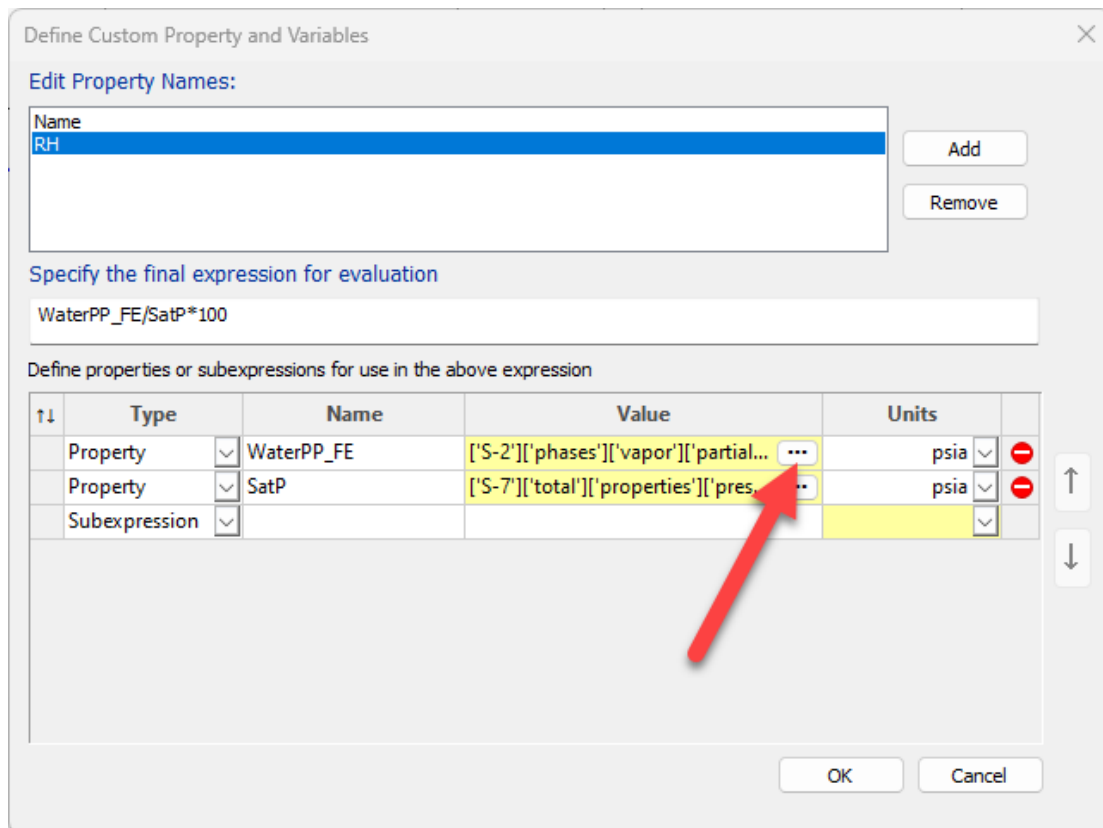

Sub-Flowsheet

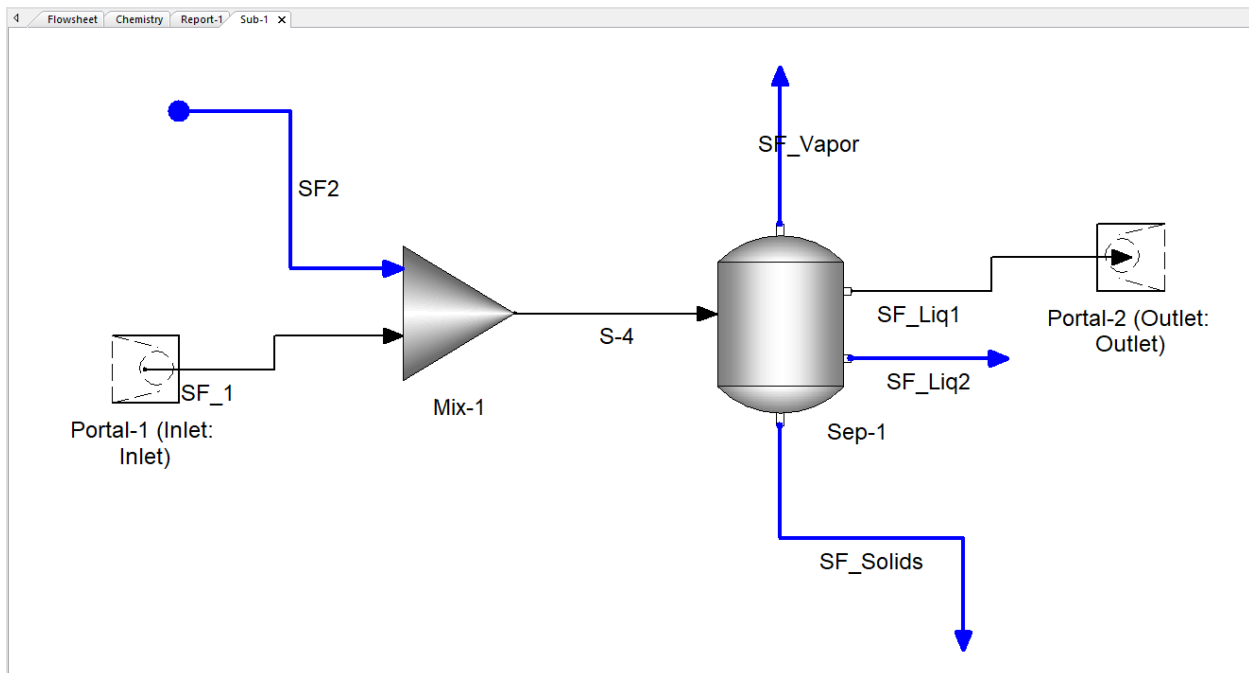
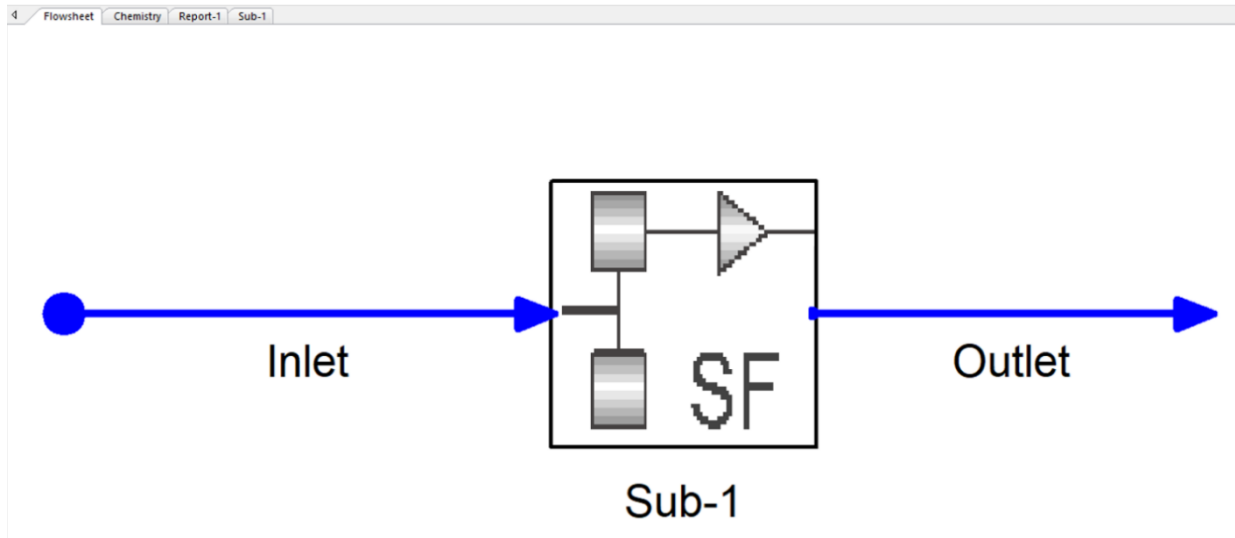

Data Requirement

On the main flowsheet, the subflowsheet needs the same number of inlet streams as it has inlet portals and the same number of outlet streams as it has outlet portals. The number of inlet portals and outlet portals can be different. The subflowsheet does not require any inlet portals or outlet portals. Any feed stream to the unit must be defined, and its temperature, pressure, total flowrate, and composition data should be specified by the user or be the product stream from another Process Block.

Example configurations of the subflowsheet are shown below.

Zero inlet and zero outlet portals:

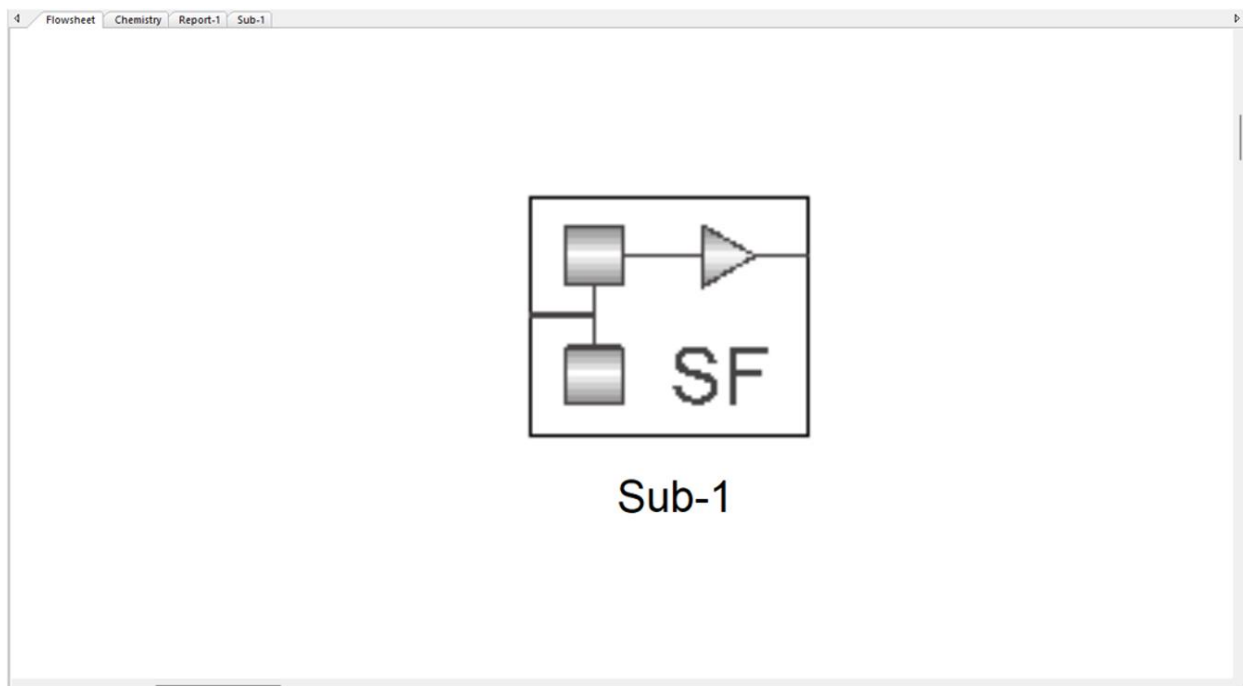
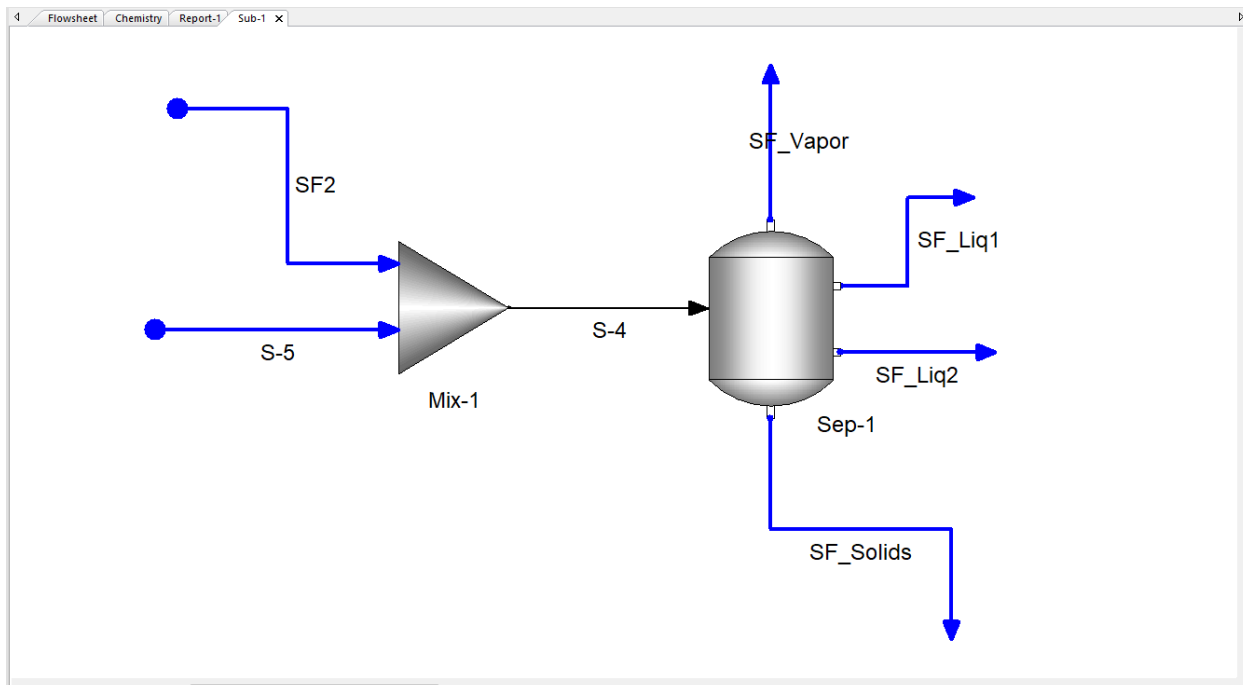

One inlet portal and zero outlet portals:

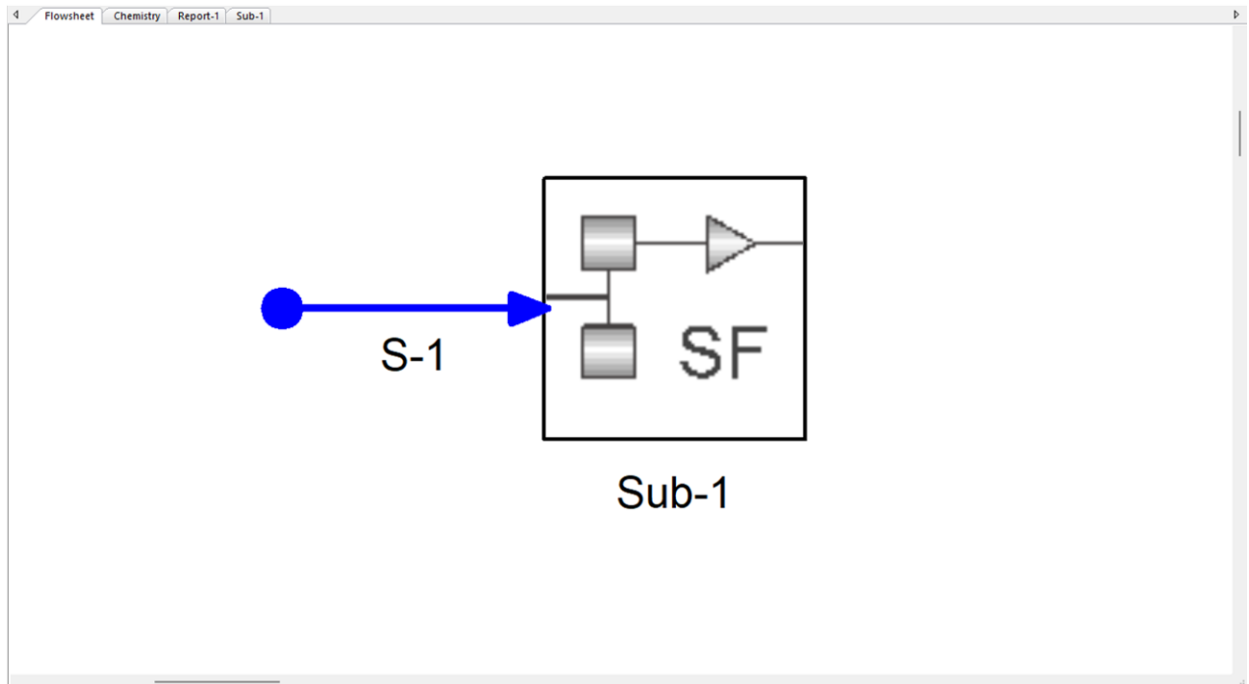
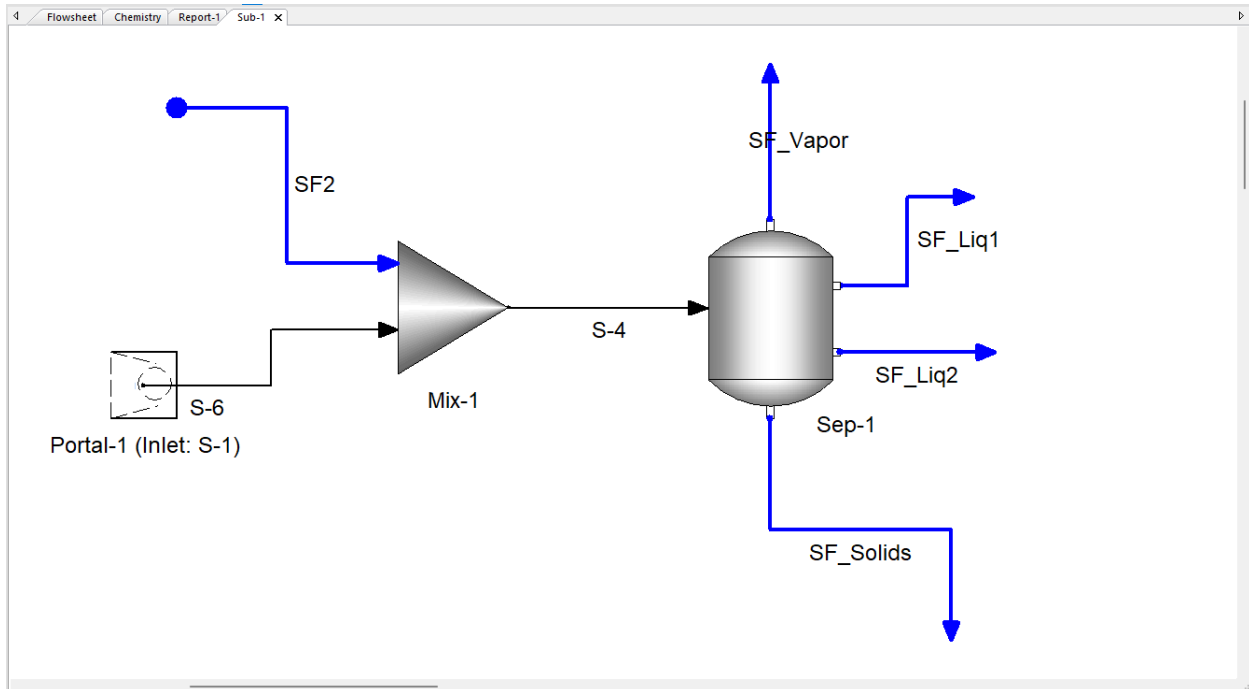

Zero inlet portals and 1 outlet portal:

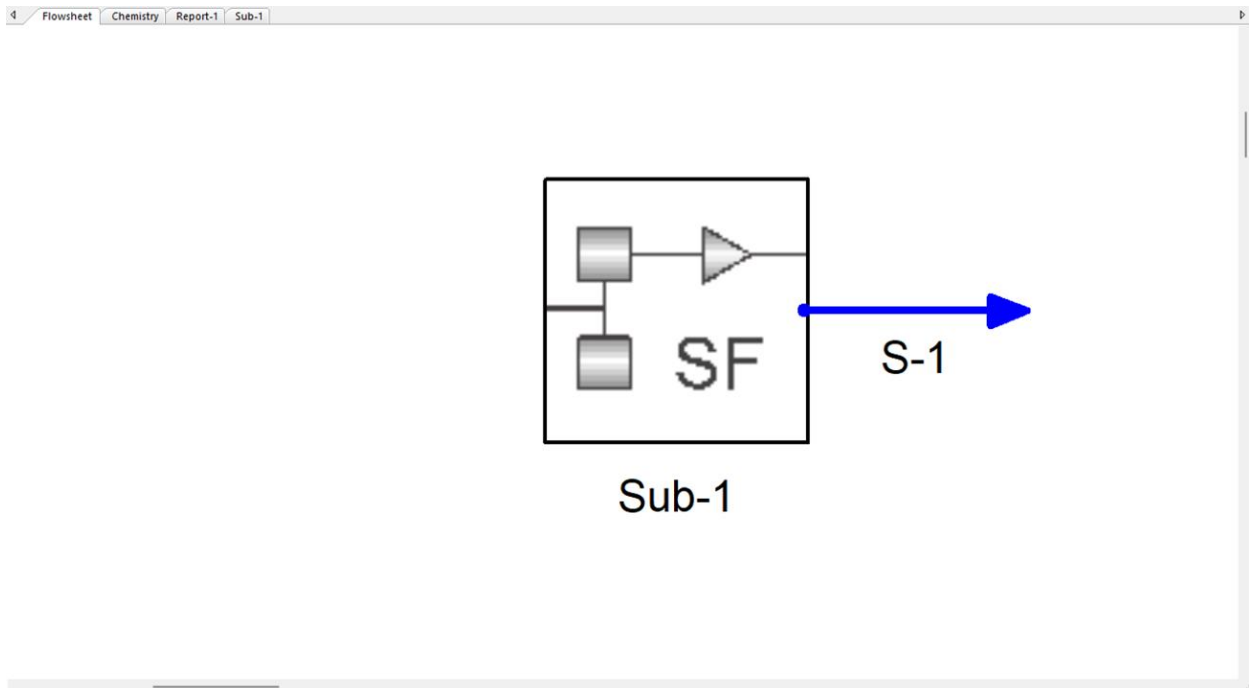
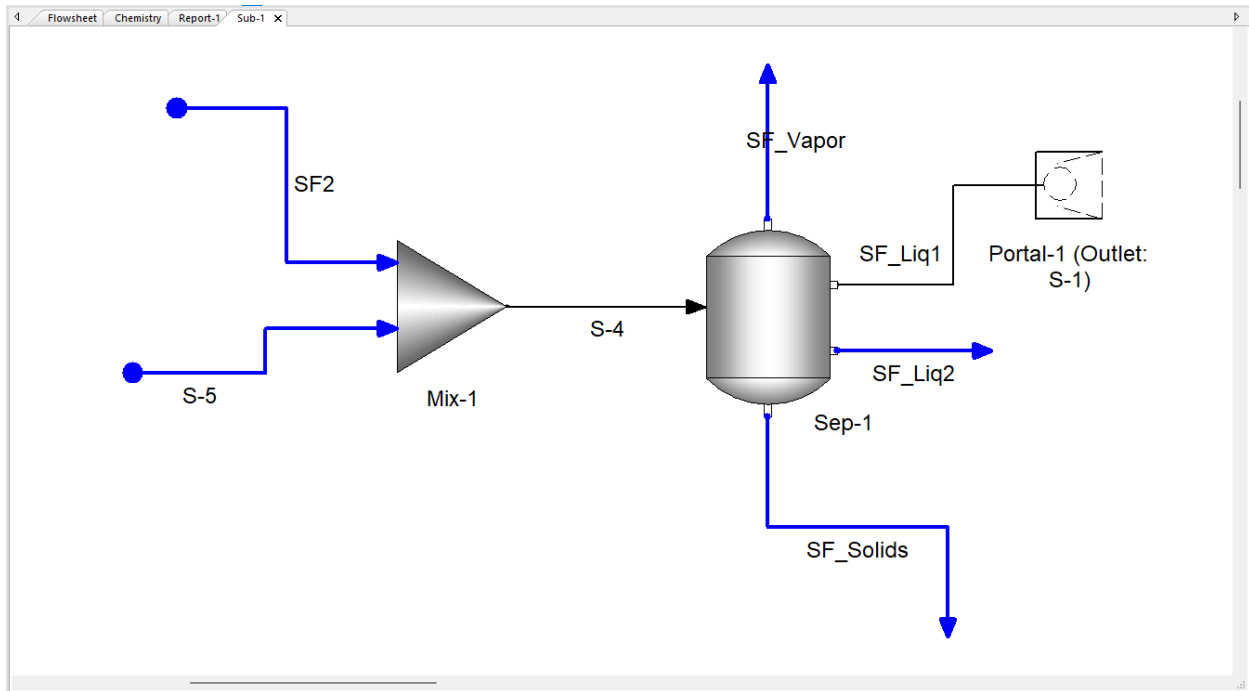

Two inlet portals and 3 outlet portals:

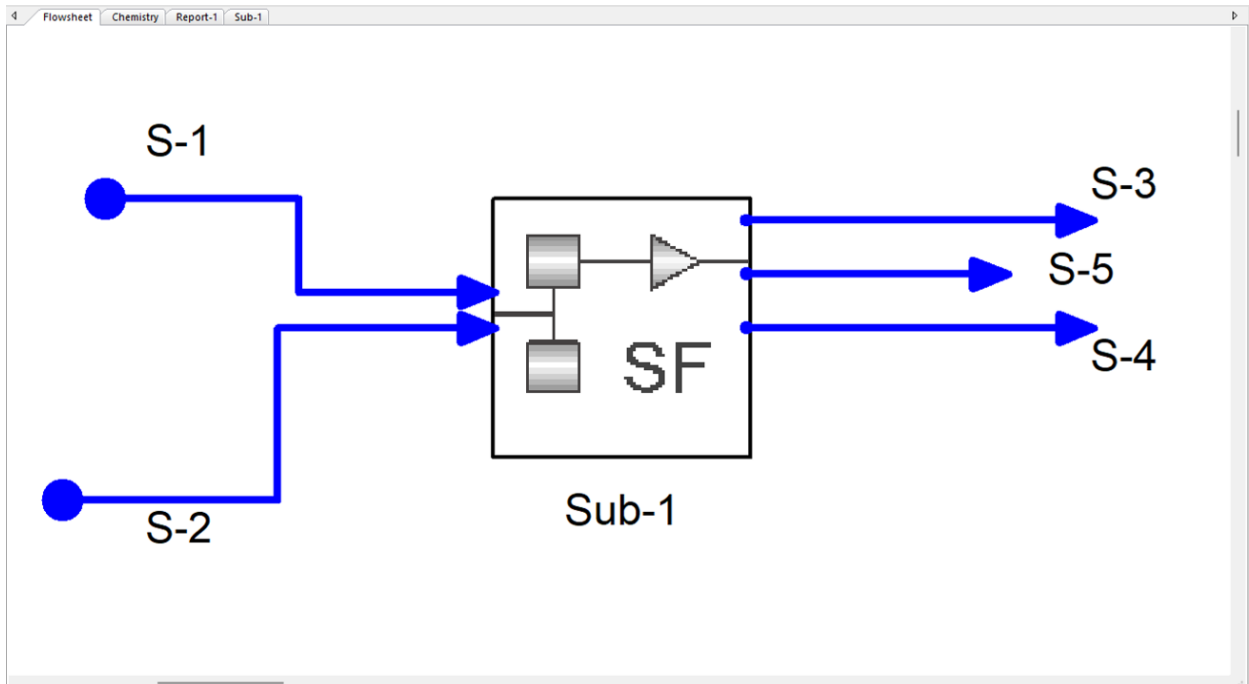
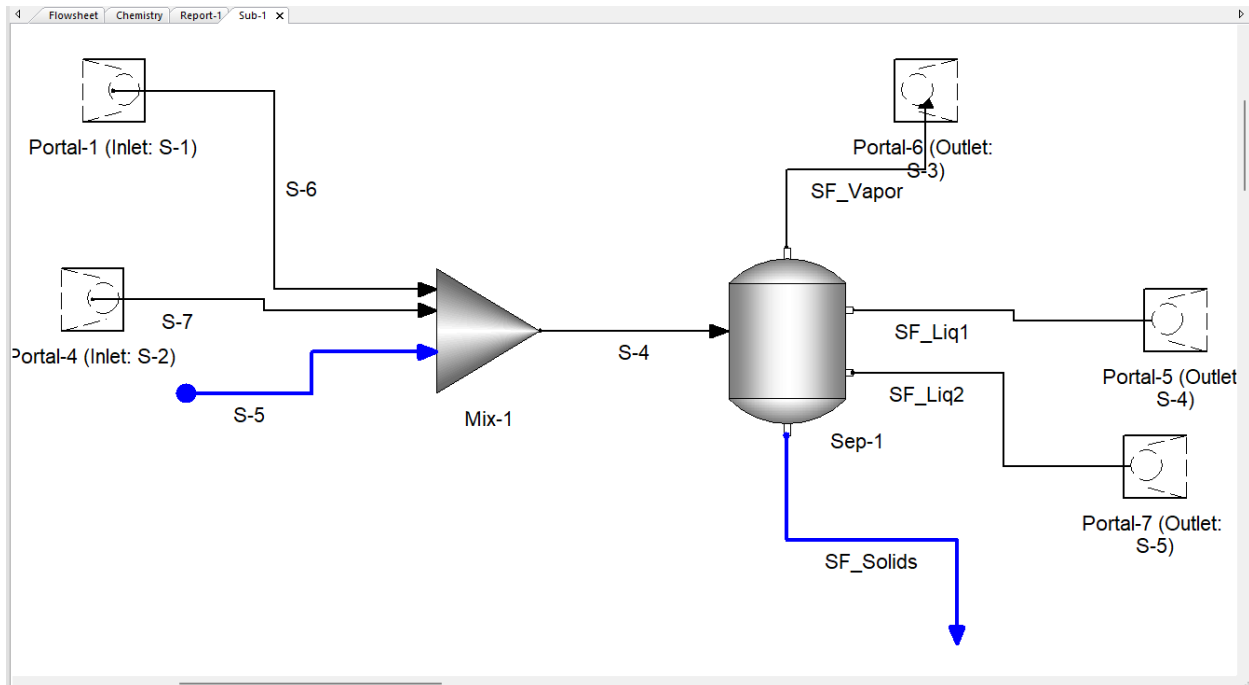

Unit Configuration

On the main flowsheet, the subflowsheet block requires the same number of inlet streams as the subflowsheet has inlet portals and the same number of outlet streams as the subflowsheet as outlet portals. Within the subflowsheet, the number of inlet portals and outlet portals can be different.

Guidelines

You can run a subflowsheet independently from the main flowsheet by selecting the Run button in the subflowsheet's Properties pane.

The screenshot displays a process simulation interface with a central flowsheet and a subflowsheet properties panel on the right.

Flowsheet Components:

- Mix-1:** Receives two inlet streams: SF_inlet_H2O+NaCl and SF_inlet_organics. Its outlet is S-1.
- Sep-1:** Receives S-1. It has three outlet streams: SF_Outlet Vapor, SF_Outlet Liquid 1, and SF_Outlet Liquid 2.
- SF_Outlet Solids:** Receives SF_Outlet Solids from Sep-1.

Subflowsheet Properties Panel (Sub-1 Subflowsheet):

- Definition:**
 - Process Options: Recycles, Restart Options, Block Calculation Order.
 - Advanced Options: Chemistry Model (Chemistry (Default)).
 - Simulation: Subflowsheets run automatically when the enclosing flowsheet runs. You can run this subflowsheet specifically as long as the incoming material and energy streams have been calculated.
- Run Button:** A red arrow points to the 'Run' button (represented by a play icon) in the Simulation section.

The OLI Support Center has more information about subflowsheets here: <https://support.olisystems.com/hc/en-us/articles/43682205700499-Introduction-to-Subflowsheets-in-OLI-Flowsheet-ESP>

Chapter VI – Analyses Tab

In this section, we will explore how to set up the different Analyses available in OLI Flowsheet: ESP; these are: Sensitivity Analysis, Water Analysis, and the Optimizer tool.

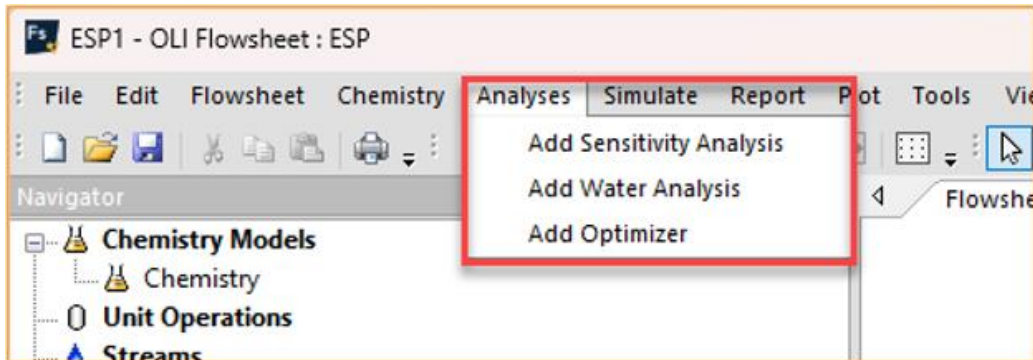

Sensitivity Analysis

HF Titration

When a stream containing HF is mixed with a stream containing CaCl_2 , a retrograde effect on pH can be observed. To perform this sensitivity analysis, please follow the procedure listed below.

Chemistry and Thermodynamic Framework

Add HF and CaCl_2 in the chemistry model under the chemistry tab:

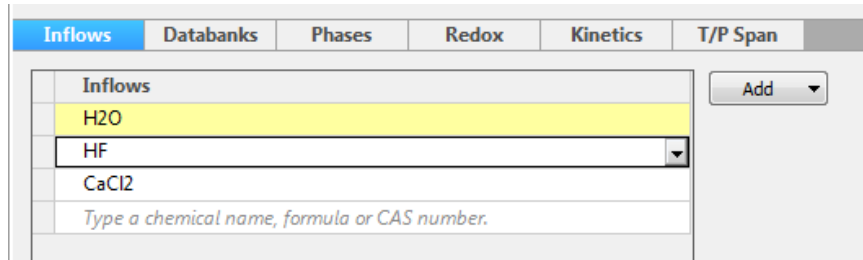

The framework we will be selecting for this example is the default MSE framework. If you click on the Databanks tab as shown in the image below, you are able to select the preferred databank:

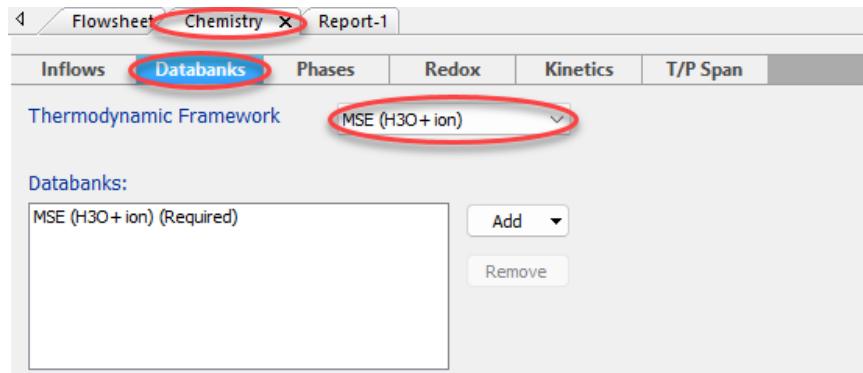

Flowsheet

To see the effect of the CaCl_2 flow rate on the pH of the mixed stream, a manipulator block is needed for controlling the CaCl_2 stream composition.

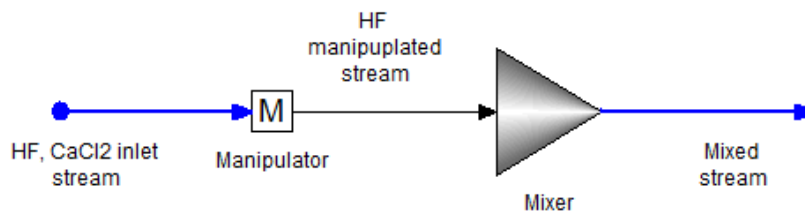

Composition and setup

Input the following set of conditions for the Inflows and the Parameters.

Parameter/Inflow	Value
Temperature (°C)	30
Pressure (atm)	1.0
Total Flow (mol/hr)	(56.6082 – automatically filled in by specifying the component flow rates)
H ₂ O (mol/hr)	55.5082
HF (mol/hr)	0.1
CaCl ₂ (mol/hr)	1.0

Properties Tab

Definition of HF, CaCl₂ inlet stream

The screenshot shows the 'Properties' dialog box for 'HF, CaCl₂ inlet stream'. It has three tabs: 'Definition', 'Calculated', and 'General'. The 'Definition' tab is active. At the top, there is a link 'Show Ionic Input Options'. Below that is the 'Parameters' section with the following values:

Parameter	Value
Temperature (°C)	30.0
Pressure (atm)	1.0
Total Flow (mol/hr)	56.6082

Below the parameters is the 'Inflows (mol/hr)' section:

Component	Value
H ₂ O	55.5082
HF	0.1
CaCl ₂	1.0
Total	56.6082

At the bottom is the 'Advanced Options' section:

Set Phase	No Special Condition
Chemistry Model	Chemistry (Default)

Mixer specifications

This is an Isothermal calculation type with 30°C temperature and 1 atm absolute pressure.

The screenshot shows the 'Properties' dialog box for a 'Mixer'. It has three tabs: 'Definition', 'Calculated', and 'General'. The 'Definition' tab is active. It shows the following configuration:

Inlets:

- Feed 1: HF manipulated stream
- Feed 2: (empty)

Outlets:

- Outlet: Mixed Stream

Equilibrium Calculation:

- Calculation Type: Isothermal
- Temperature (°C): 30.0
- Pressure Spec.: Absolute Pressure
- Pressure (atm): 1.0

Advanced Options:

- Chemistry Model: Chemistry (Default)

Manipulator specifications

The manipulator's parameter specification needs to be set to "Stream Components" so that the sensitivity analysis can vary the CaCl₂ flow rate.

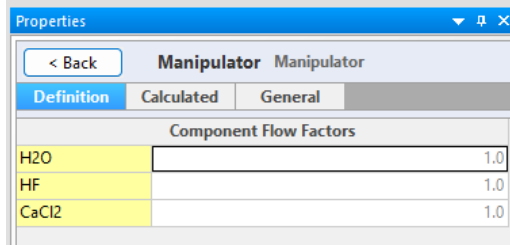
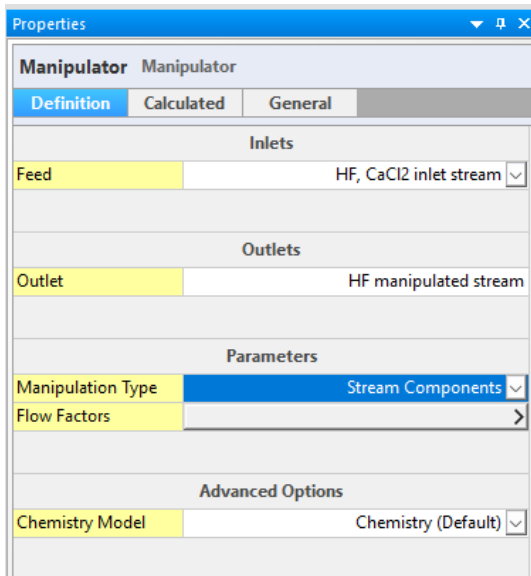

Create Analysis

Click on the Analysis option at the top toolbar:

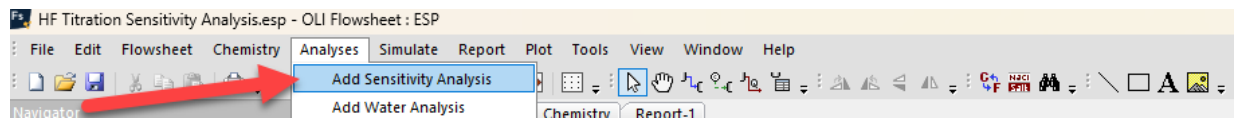

You will see the following screen:

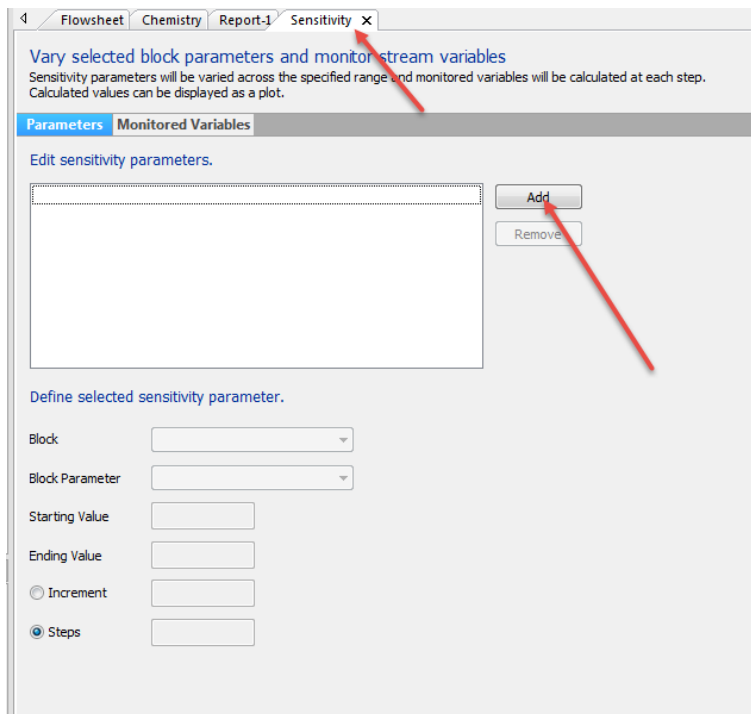

Click on the Add button and select the Block to be Manipulator block.

The screenshot shows the 'Sensitivity' window with the 'Parameters' tab selected. The title is 'Vary selected block parameters and monitor stream variables'. Below the title, it states: 'Sensitivity parameters will be varied across the specified range and monitored variables will be calculated at each step. Calculated values can be displayed as a plot.' The 'Parameters' section has a list containing '<New Parameter >' with a checked checkbox. To the right are 'Add' and 'Remove' buttons. Below this is the 'Define selected sensitivity parameter' section. The 'Block' dropdown is set to '<Select>'. The 'Block Parameter' dropdown is open, showing 'Manipulator' and 'Mixer', with 'Manipulator' circled in red. The 'Starting Value' field is empty. The 'Ending Value' field is empty. The 'Increment' radio button is unselected, and the 'Steps' radio button is selected.

Use the drop-down on the Block Parameter and select the Flow Factor, CaCl₂. Your final screen with the starting value 0.0 and ending value 0.2 with 20 steps specification should match the following image:

The screenshot shows the 'Sensitivity' window with the 'Parameters' tab selected. The title is 'Vary selected block parameters and monitor stream variables'. Below the title, it states: 'Sensitivity parameters will be varied across the specified range and monitored variables will be calculated at each step. Calculated values can be displayed as a plot.' The 'Parameters' section has a list containing 'Manipulator: Flow Factor, CaCl₂; 0.0 to 0.2 in steps of 0.02' with a checked checkbox. To the right are 'Add' and 'Remove' buttons. Below this is the 'Define selected sensitivity parameter' section. The 'Block' dropdown is set to 'Manipulator'. The 'Block Parameter' dropdown is set to 'Flow Factor, CaCl₂'. The 'Starting Value' field contains '0.0'. The 'Ending Value' field contains '0.2'. The 'Increment' radio button is unselected, and the 'Steps' radio button is selected, with the 'Steps' field containing '20'.

Monitored Variables

Now that we have selected the parameters to vary, we need to select the monitored variables to create the plot. If you click on the Monitored Variables tab, you will see the following screen; click on the Add button:

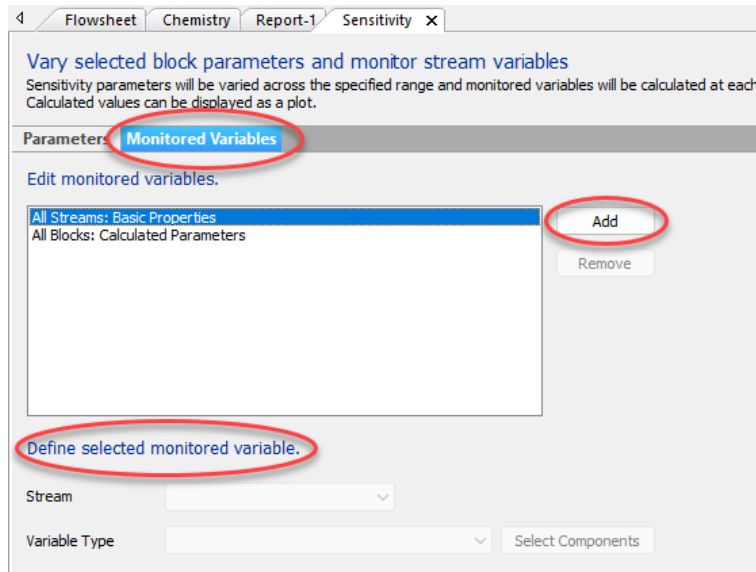

Select the Mixed Stream and the Variable type as Composition, True (Speciated):

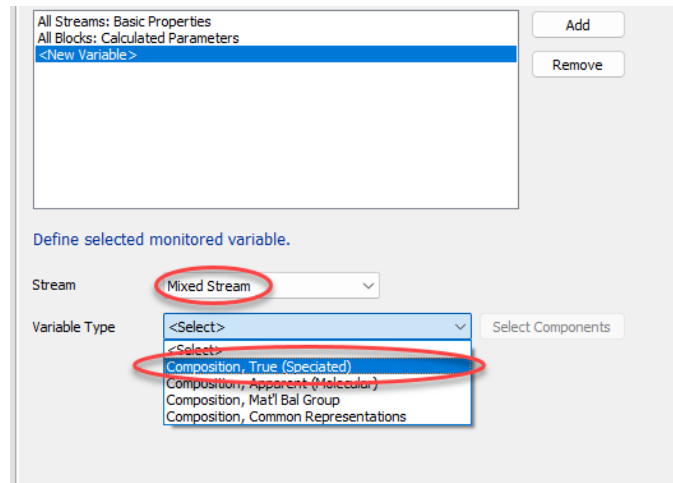

You will see the following error message after you make your selection, which will need you to select a specific component/s for the plot:

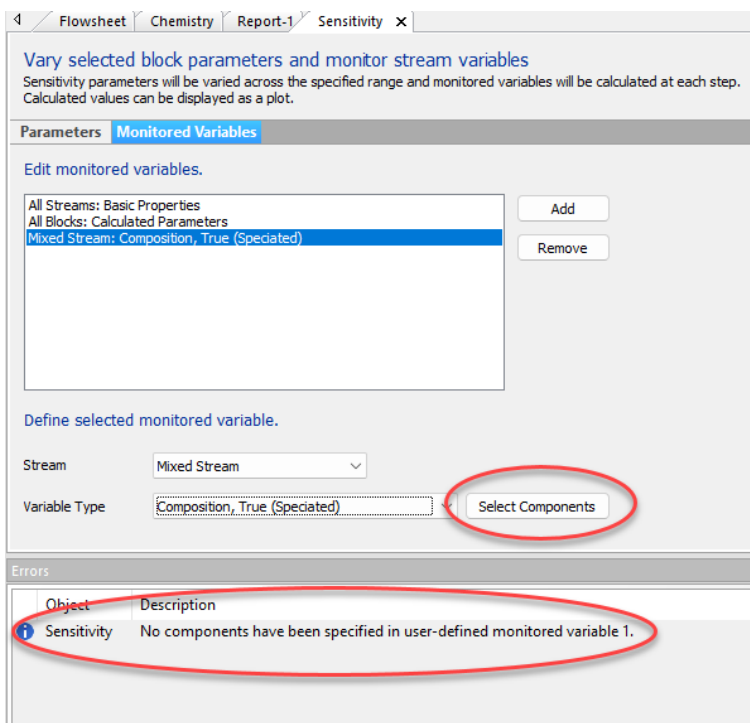

Click on the encircled Select Components option as shown in the image above which will bring you to the following pop-up window. Depending on the case, you could either select individual components or in this case all components.

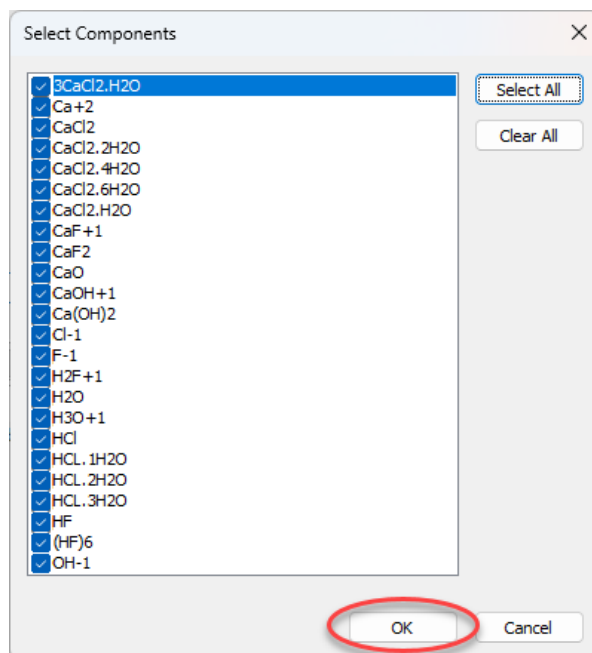

Click **OK**.

Add Sensitivity Plot

The plot needs to be added manually by going to the top toolbar again and clicking on the Plot -> Add Sensitivity Plot.

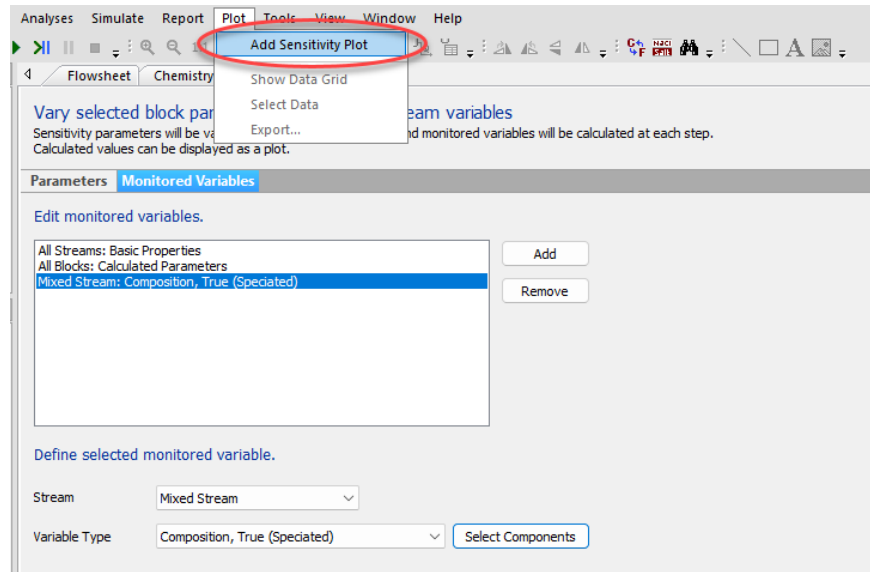

Now you will need to run the file by clicking the Run button or using a shortcut F9.



The default plot has H₂O Mixed Stream on Y axis, and you will need to click on Select Data button to customize the plot view.

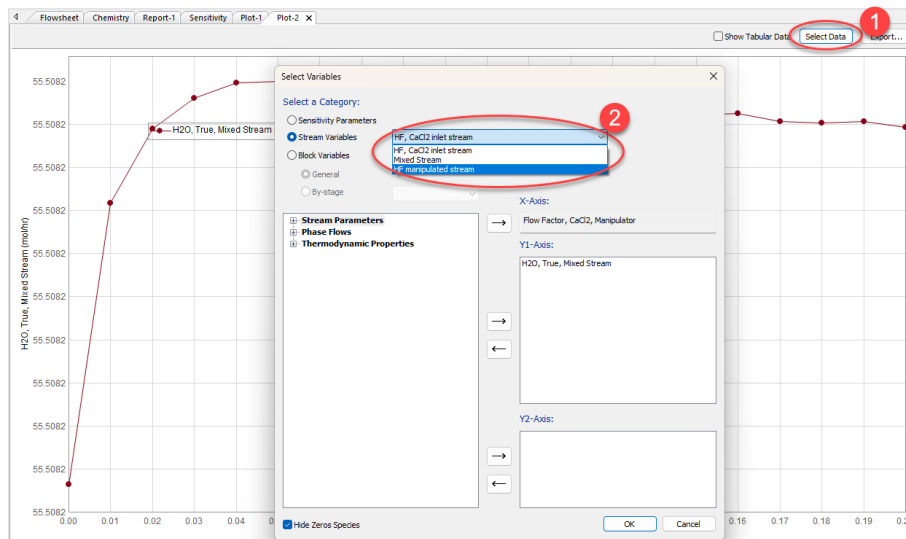

Click on Select Data

Select the Stream that you want to plot the stream variables for, in this case, since we are interested in the pH of the mixed stream, we will select the **HF manipulated stream**.

Add Mass of Solid phase for the manipulated stream and the pH as shown below. Remove the H₂O, True, Mixed Stream:

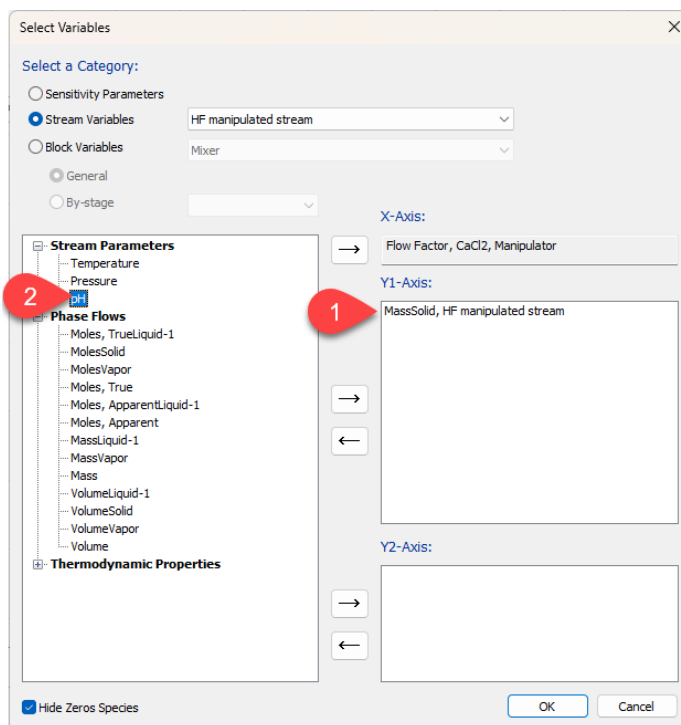

We can see from the plot below that the pH drops as the solid starts forming:

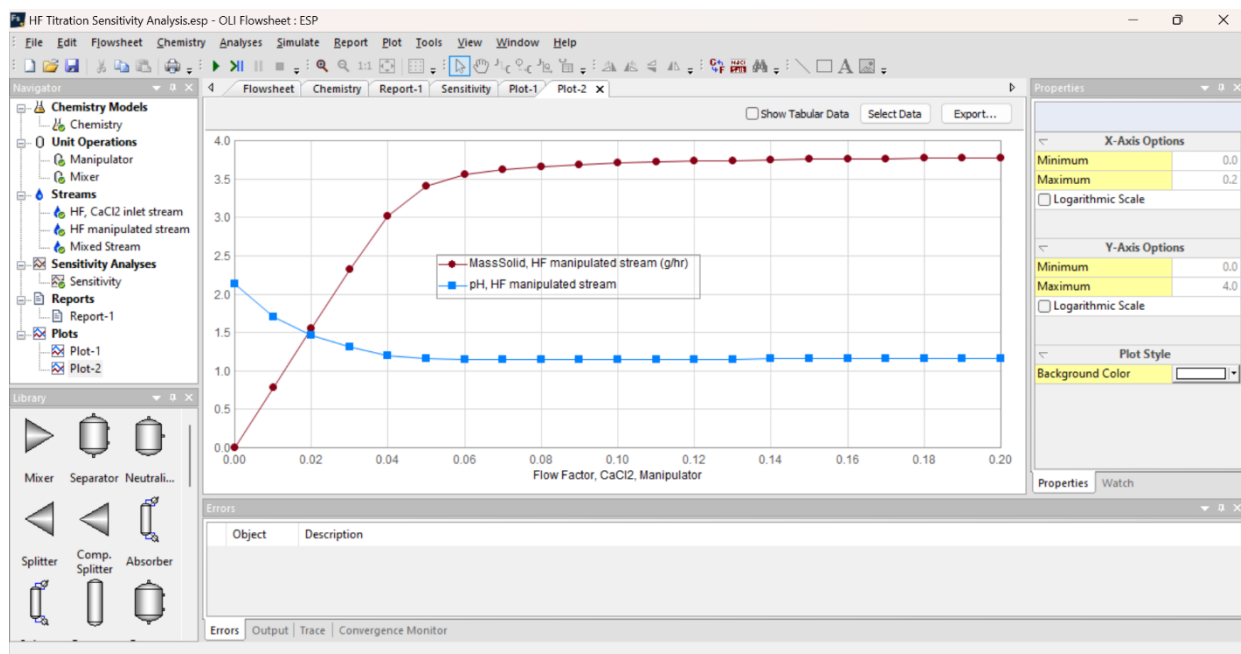

As you can see in the Properties Pane, X-axis and Y-axis can be manipulated.

You can download a worked example of this case by contacting [OLI Support](#) and requesting the HF Titration Sensitivity Analysis.esp example.

Water Analysis (Ionic Input)

OLI Flowsheet: ESP also allows the user to enter a stream as an ionic input. In this section, we will input dissolved species concentrations and other measured properties into a *Water Analysis* to model a hypothetical water sample. We will also explain the different reconciliation options available in the *Water Analysis*.

The table below shows the hypothetical water that we will create as an example.

Water Analysis							
Cations, mg/L		Anions, mg/L		Neutrals, mg/L		Measured Properties	
Na+1	36000	Cl-	57000	CO2	15	Temperature	25 °C
K+1	300	SO4-2	250	H2S	5	Pressure	1 atm
Ca+2	600					pH	6.67
Mg+2	150					Alkalinity	600
Sr+2	80					Density	1.064 g/ml
Ba+2	5					Total Dissolved Solids	96280 mg/L

Create a **Stream** in the Flowsheet

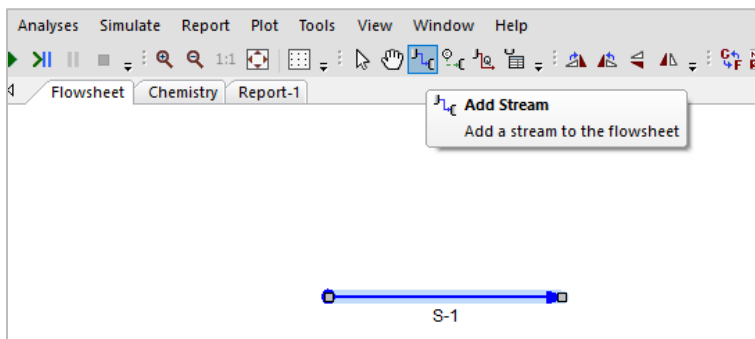

Add a Water Analysis. You have two options:

Option 1 – In the **Menu Bar** go to *Analyses > Add Water Analysis*, or

Option 2 – In the **Properties** panel, click on **Show Ionic Input Options**. Then, click on *create new*, since a water analysis has not been created yet.

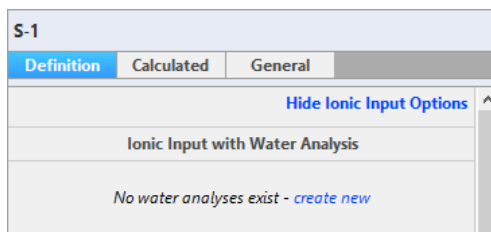

The two options for ionic input are shown in the figure below.

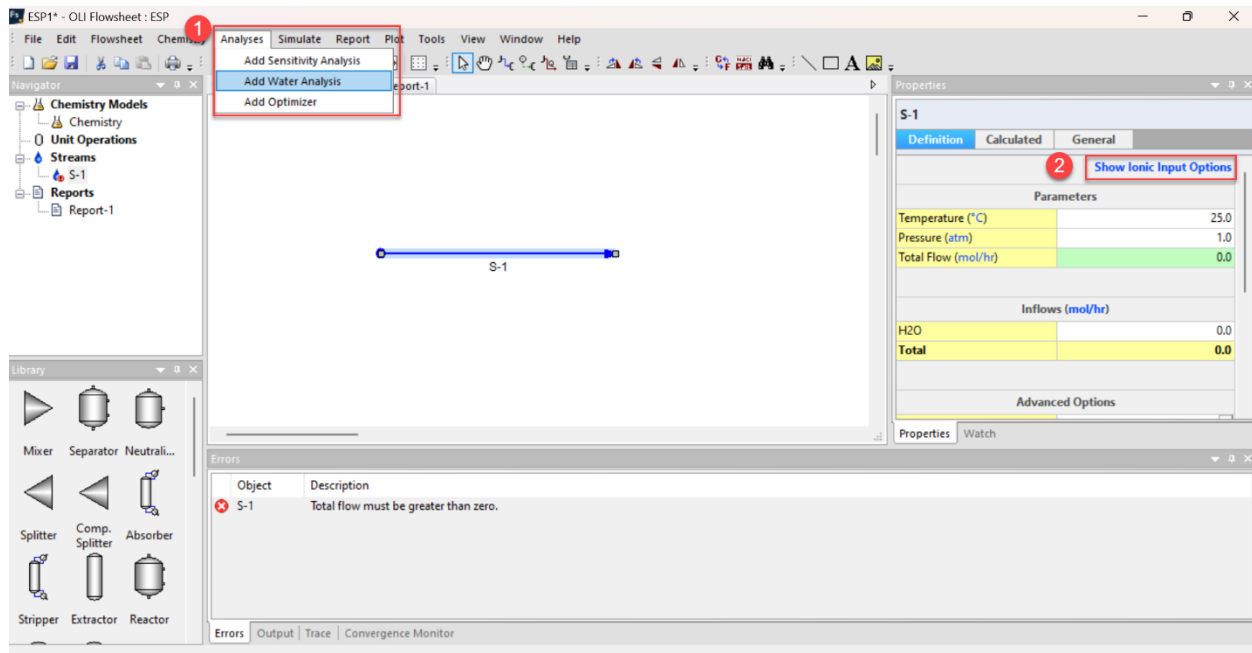

For this example, we will use **Option 1 – Menu Bar > Analyses > Add Water Analysis**. This should open a new tab named **Water Analysis-1**.

Water Analysis-1 Composition Table:

Component	Value	Balanced
mg/L		
Cations		
Na+1	0.0	0.0
K+1	0.0	0.0
Ca+2	0.0	0.0
Mg+2	0.0	0.0
Sr+2	0.0	0.0
Ba+2	0.0	0.0
Fe+2	0.0	0.0
Anions		
Cl-1	0.0	0.0
SO4-2	0.0	0.0
HCO3-1	0.0	0.0
HS-1	0.0	0.0
C2H3O2-1	0.0	0.0
Neutrals		
CO2	0.0	0.0
H2S	0.0	0.0
SiO2	0.0	0.0
B(OH)3	0.0	0.0

Water Analysis-1 Properties Panel:

- Calculate properties using:
 - Concentration data only
 - Gas-phase CO2 content
 - Measured pH only
 - Measured pH and alkalinity
 - Measured pH, alkalinity and TIC
 - Calculate alkalinity
- Allow solids to form:
- Properties:
 - Temperature (°C): 25.0
 - Pressure (atm): 1.0
 - pH: [blank]
 - Alkalinity (mg HCO3/L): [blank]
 - Density (g/ml): [blank]
 - Elec Cond, specific (µmho/cm): [blank]
 - Total Dissolved Solids (mg/L): [blank]
 - TIC (mol C/L): [blank]
 - Alkalinity Titration End Point pH: 4.5

Enter the composition of the Water Analysis given in the table above. Make sure to enter the concentration of cations, anions, and neutrals, as well as the conditions at which the properties of the solution (such as pH, alkalinity, density, etc.) were measured.

Reconciliation Options

When reconciling a Brine Analysis, there are five options for reconciliation:

Concentration Data Only: The software will run an electroneutrality reconciliation only, and then compute the water properties such as pH, density, etc., based on the entered concentration of neutral, cations, and anions species. In the **Concentration Data Only** option you may allow the program to pick the species to adjust for electroneutrality or you may manually choose the species to perform the adjustment.

Use Concentration Data Only when:

- Species concentrations are accurate
- Need to calculate properties using concentration data only
- Good for what-if iterations

Gas-phase CO₂ content (mole%): Frequently, it is simpler and more stable to measure the gas-phase CO₂ that is separated from the brine at the sampling point. When matched with another measured variable, usually alkalinity, the concentration of the carbonate species and the pH can be calculated. OLI Flowsheet: ESP performs a CO₂ gas fraction calculation by taking the P_{CO₂} and the calculated alkalinity (based on the water analysis data) to reconcile the system for pH and carbonate properties. The CO₂ is adjusted to match a saturated gas composition.

Use Gas Phase CO₂ Content (mole%) or Fix CO₂ Fraction in Gas when:

Use Concentration Data Only when:

- P_{CO₂} in produced gas is known
- Need to calculate at T/P under which the gas measurement was taken
- ScaleChem adjusts CO_{2T}, until the calculated P_{CO₂} equals the entered value

Measured pH Only: Many brine analyses report a measured pH. This pH may or may not match the pH calculated by the software. The cause may be an incomplete and/or inaccurate brine description. The software will run both an electroneutrality and pH reconciliation. This type of reconciliation will match your recorded pH. Additionally, the software will compute the water properties such as density, electrical conductivity, etc. The pH of the solution is automatically adjusted by the software by adding either HCl or NaOH, or you may select your preferred acids and bases to adjust the pH.

Use Measured pH Only when:

- pH is accurate
- Need to calculate at T/P that the pH was taken
- ScaleChem adjusts H⁺, Cl⁻, until the calculated pH matches the measured value

Measured pH and Alkalinity: The purpose of the Measured pH and Alkalinity reconciliations is to match the computed pH and alkalinity values with those you measured. The software will run an electroneutrality, pH, and alkalinity reconciliation. Additionally, the software will compute the water properties such as density, electrical conductivity, etc. The pH of the solution is automatically adjusted by the software by adding either HCl or NaOH, or you may select your preferred acids and bases to adjust the pH. The Alkalinity is automatically calculated by the software, using CO₂ as the alkalinity titrant, H₂SO₄ as the alkalinity pH titrant, and 4.5 as the alkalinity end point pH. You can also change a different alkalinity titrant if you prefer.

Use Measured pH and Alkalinity when:

- pH and alkalinity data are accurate
- Need to calculate at T/P that the pH was taken
- ScaleChem adjusts H^+ , Cl^- , and CO_2 until the calculated pH/alkalinity equals measured values

Measured pH, Alkalinity, TIC: The purpose of this reconciliation is to match the measured pH, total alkalinity, and the total inorganic carbon (TIC). The Total Inorganic Carbon (TIC) is adjusted using CO_2 as the alkalinity titrant, H_2SO_4 as the alkalinity pH titrant, and 4.5 as the alkalinity end point pH. The software adjusts the acetate concentration (organic acids) to match the total Alkalinity value by adding or removing acetic acid. You cannot, however, change the CO_2 or acetic acid for the alkalinity adjustment. These are fixed by the software. The target pH is obtained simultaneously by HCl or NaOH. You may select your preferred acids and bases to adjust the pH instead of the default HCl and NaOH.

Use Measured pH, Alkalinity, and TIC when:

- pH, alkalinity, and TIC data are accurate
- Calculate at T/P that the pH was taken
- ScaleChem adjusts H^+ , Cl^- , CO_2 , and Acetic Acid until the calculated pH/alkalinity/TIC equal measured values

Additionally, there is the option to **Calculate Alkalinity**. It is important to note that this is only an alkalinity calculation based on the concentration entered; it is not an alkalinity reconciliation.

Optimizer Analysis

Note: The optimizer tool requires an add-on license

This section of the manual is under constant revision. Please see the latest updated information and examples at <https://support.olisystems.com/hc/en-us/articles/44648093558547-OLI-Flowsheet-ESP-Optimizer-Documentation-and-Examples>

In this example, we will use the Optimizer Analysis tool (hereafter referred to as the Optimizer) to determine the minimum amount of wash water needed to prevent under-deposit corrosion in an overhead crude distillation unit. The basic application of the under-deposit corrosion has been found in many places in the OLI literature.

Describing the Sample Case

Please download the case file without the optimizer added. The case can be found here:

https://support.olisystems.com/hc/en-us/article_attachments/44648247877395

Save the file in a working folder and then open the case file with OLI Flowsheet: ESP version 12.5 or later.

You should see the following:

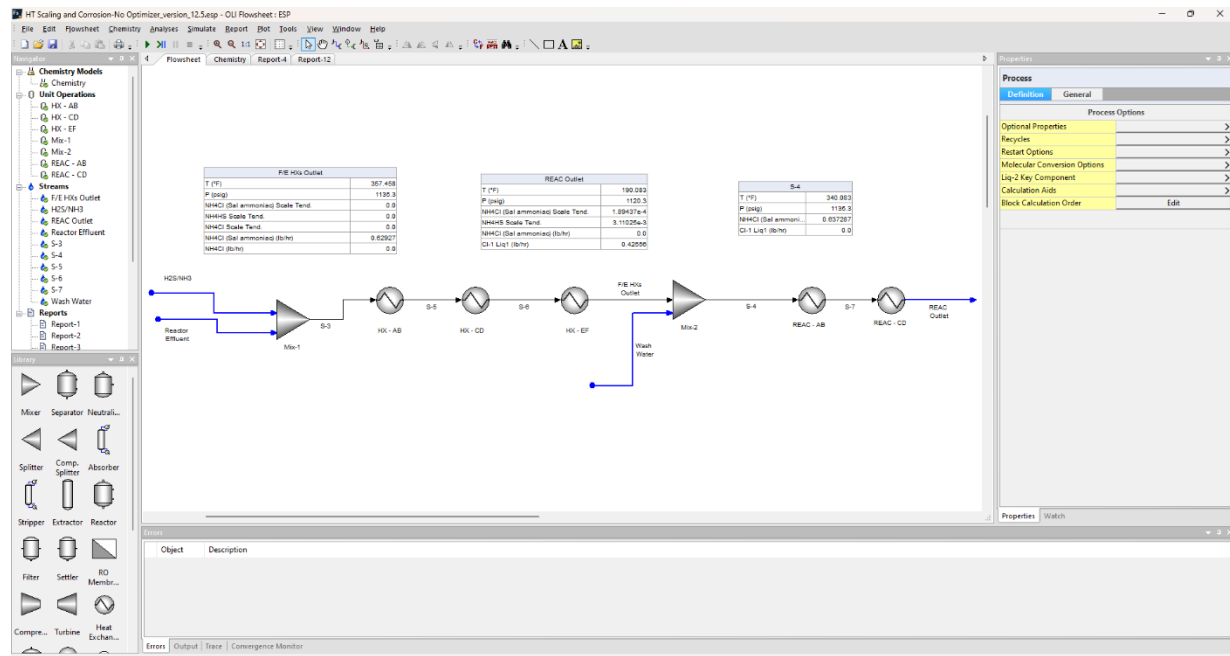

Let us describe the process in a bit more detail.

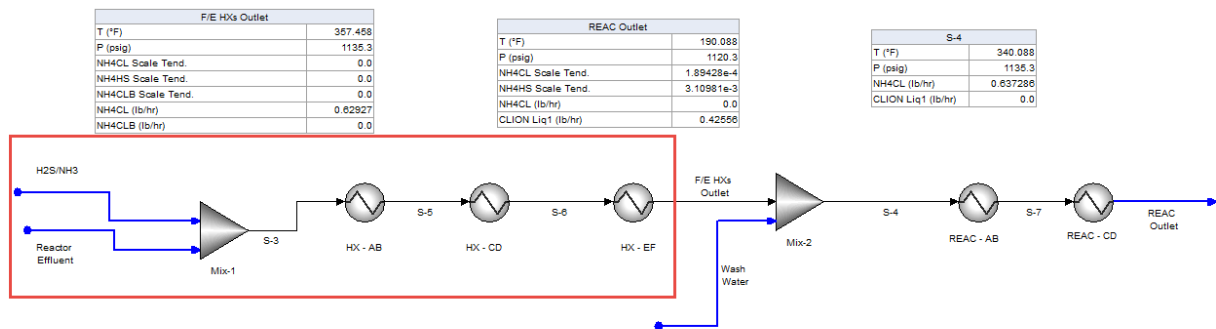

This section of the process represents a typical configuration for a REAC effluent cooling system.

Heat is recovered from the effluent of the reactor through heat exchange with the reactor feed, fractionation section feed, and recycled hydrogen gas. During the cooling process of the vapors, the presence of Ammonia (NH_3) and Hydrogen Sulfide (H_2S), which originate from Sulfur and Nitrogen in the feed and undergo hydrogenation in the reactor, can lead to the formation of Ammonium Hydrogen Sulfide (NH_4HS) and, in the presence of Hydrogen Chloride (HCl), Ammonium Chlorides.

These solid substances can accumulate on the tubes of the air cooler, reducing heat transfer efficiency and potentially causing tube blockages. Additionally, since water is commonly injected into the inlet piping of the HPS vapors air cooler, there may be some humidity present due to water flashing. The hygroscopic nature of the salts can attract moisture from the environment, resulting in the formation of corrosion hotspots.

Operators usually inject some wash water to dissolve these deposits and, thus, protect the lines. However, it is essential to predict the minimum quantity of water to be injected, to ensure the effectiveness of the salt's dissolution program.

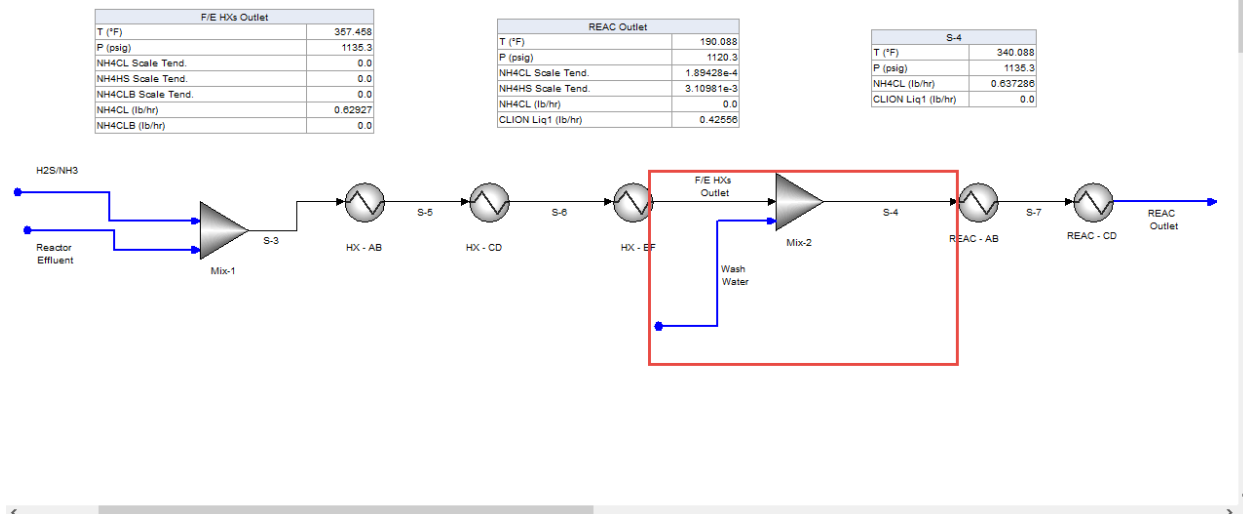

This section represents the injection of wash water. This will also result in further cooling of the line before it reaches the air coolers just downstream. Water is expensive and can cause degradation of the product so it will eventually have to be removed. It will be required to remove this added water later in the process. It would be of great benefit to allow the program to optimize the amount of wash water to be added to just minimize the formation of the under-deposit solids.

OLI Flowsheet: ESP can accomplish this for us.

Adding the Optimizer Analysis

We start by adding a new type of analysis called an optimizer. Select a new optimizer from the **Analyses** menu item:

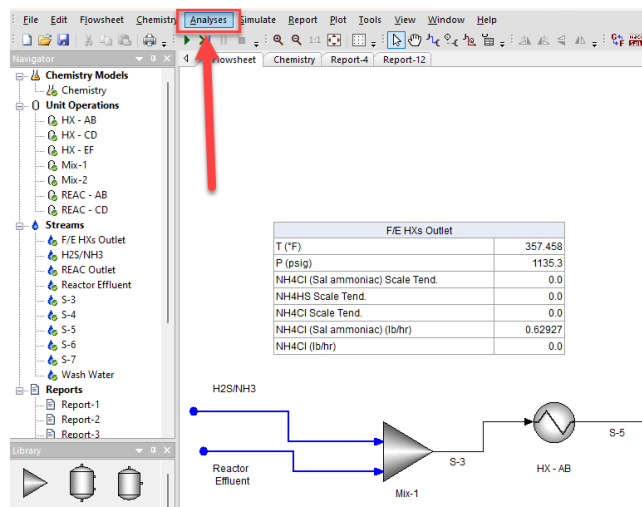

Select Add Optimizer

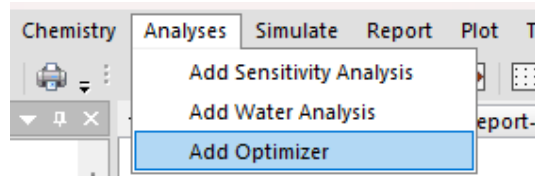

The initial panel looks like this:

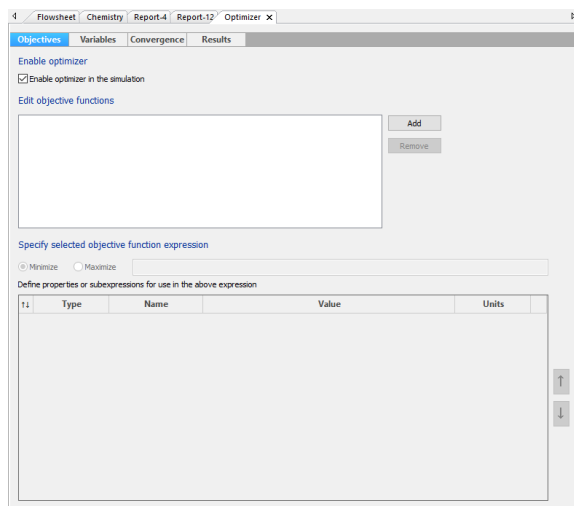

There are many new features here so each should be discussed in turn.

Enable optimizer

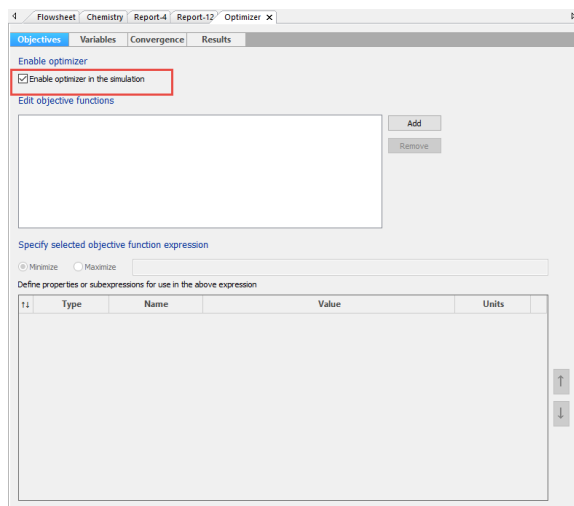

Check this box to enable the optimizer for this document. Once you have optimized this function, you can update the process file with the new value(s) and continue to run your optimization. Since it is already optimized at that point, you can disable the optimizer code. For now, we will leave this checked.

Edit objective functions

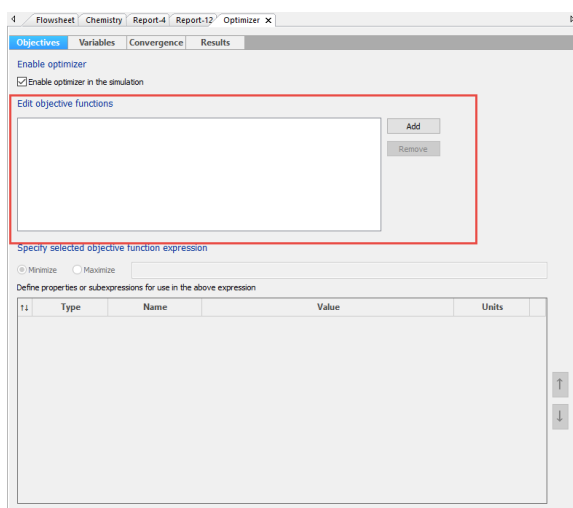

In this box we will add our objective functions. These functions are as varied as your imagination. OLI will continue to post new techniques as we develop them on our [support center page](#) (see above). We will fill out this panel in the next section. To enable this panel, we would click the **Add** button. Do so now.

Specify the selected objective function expression

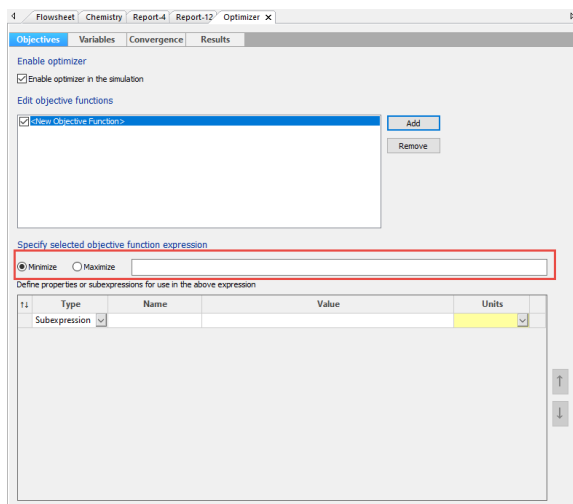

You will eventually define whether to minimize or maximize the objective function. This will become clearer in a minute.

Define properties or subexpressions for use in the above expression

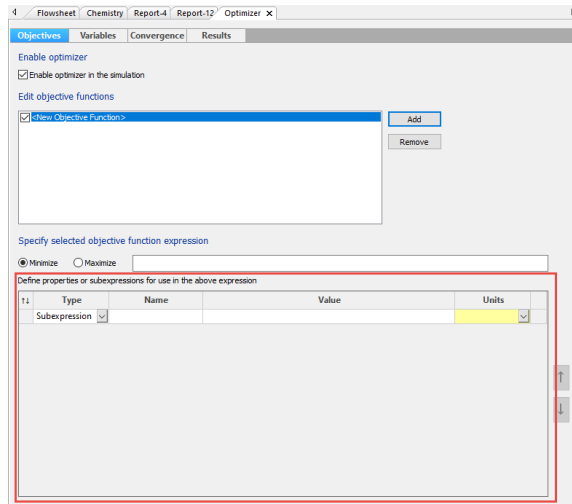

Here is the essence of the optimizer. We will create a series of expressions and variables that allow us to have something to optimize.

Let us dig into this further.

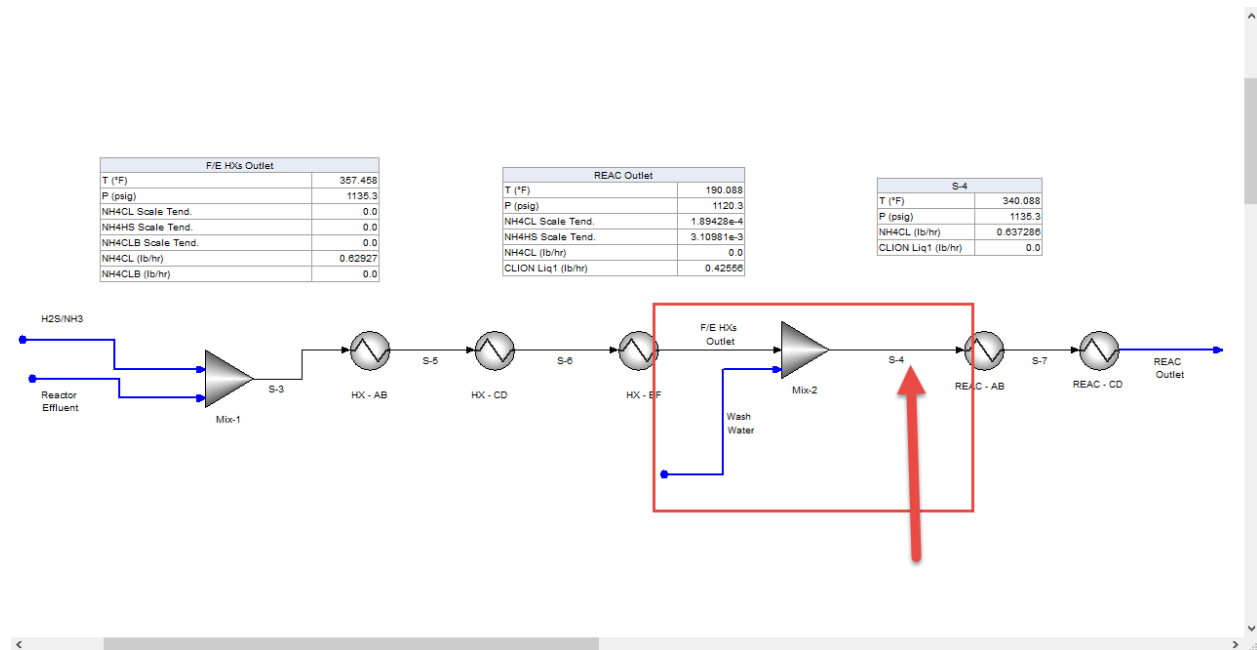

Our objective is to add just enough “Wash Water” to make sure we have no solids in stream “S-4.” This is a roundabout way of saying we want to minimize the amount of wash water.

We now must discuss some things that are unique to OLI Flowsheet: ESP. Imagine a plot where we have solids on one side of a break point and no solids on the other. Here is such an example (using OLI Studio in this case).

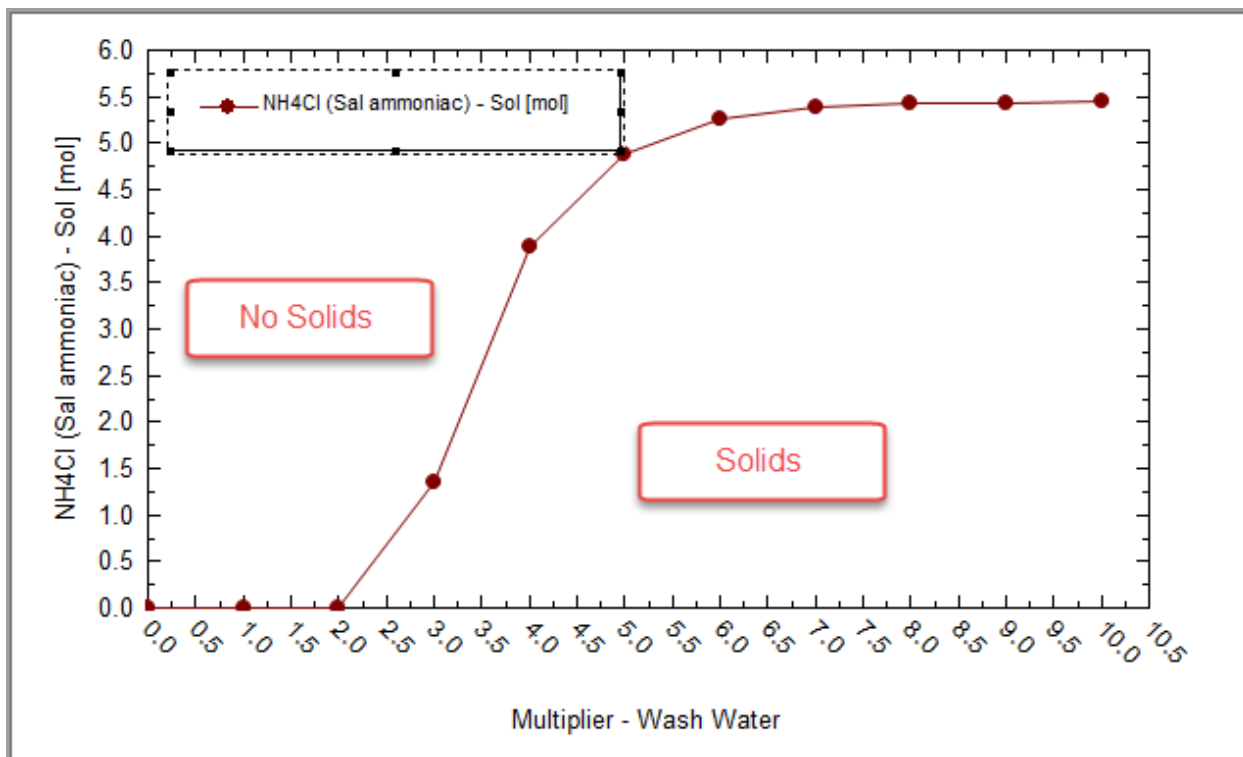

The question you may have is: “Why not use a controller to find the minimum amount of wash water?” There are two answers: 1) a controller only finds a set point that the operator needs to define which may or may not be a minimum value, and 2) when the controller accidentally solves in the “No Solids” region, there is no slope to the curve to find its way back to a solution.

This is where writing your own objective function works so well. We are going to define a variable which will be the sum of all the chloride species (liquid, organic, and solid phases), which is a continuous function in the numerical space.

We are first going to define a variable which is the amount of chloride species in the liquid phase of our target stream “S-4.”

Specify selected objective function expression

Minimize Maximize

Define properties or subexpressions for use in the above expression

↑↓	Type	Name	Value	Units
	Subexpression			

↑

↓

Change the drop-down box from **Subexpression** to **Property**

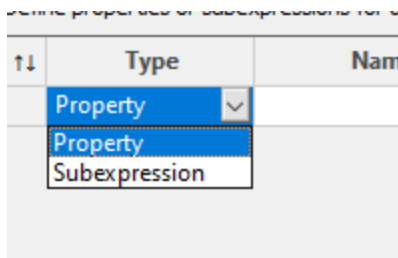

We will now start to enter our first variable

Specify selected objective function expression

Minimize Maximize

Define properties or subexpressions for use in the above expression

↑↓	Type	Name	Value	Units
	Property		Use the "..." button to select a property	

1 2 3

In the box #1, enter the name "Chlorides" and then click the "..." box (#2) to enter the expression. Finally, enter the units in Box #3 when it becomes active.

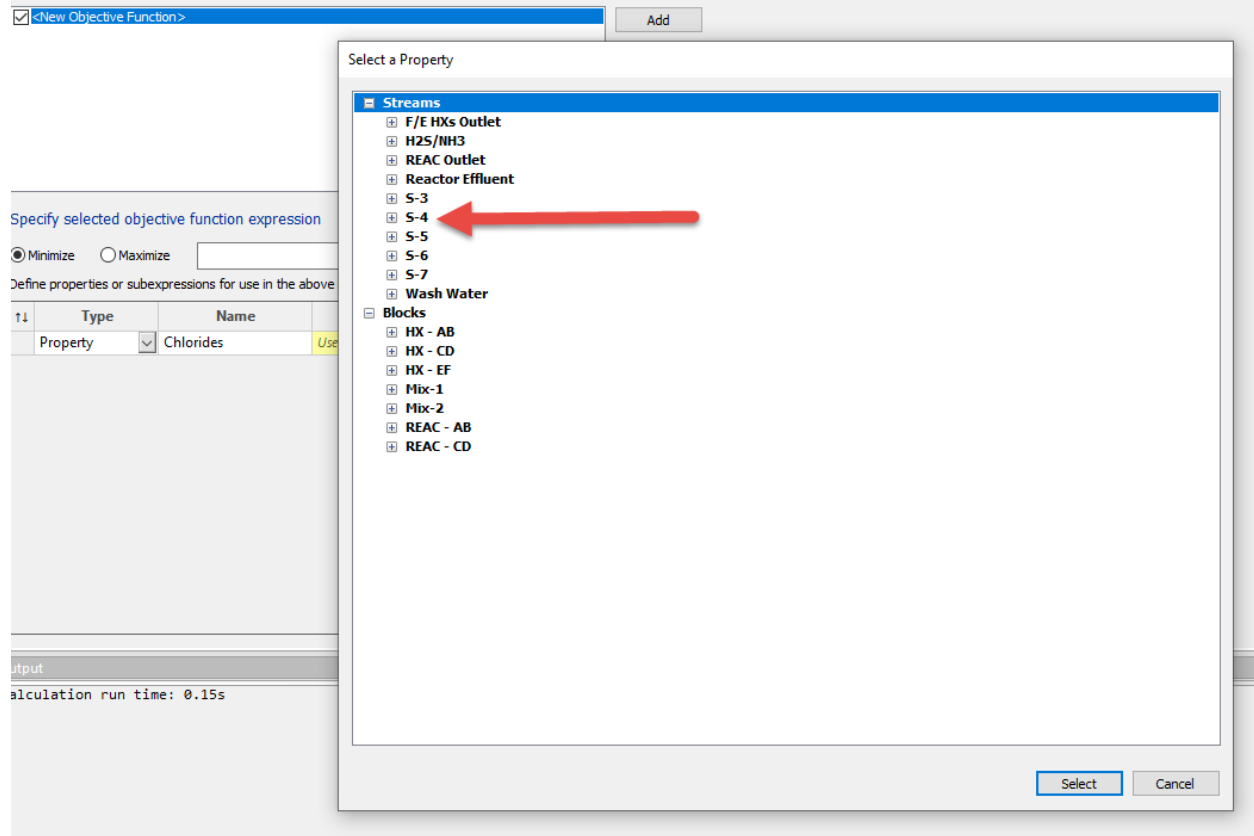

This is what the dialog looks like after clicking the “...” box

Expand the stream “S-4”

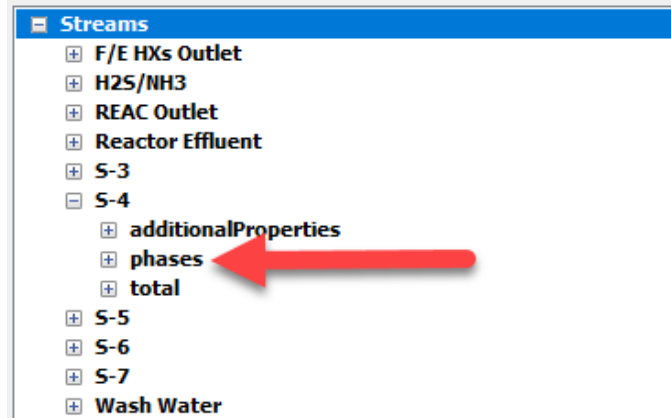

Now expand “phases” since we only want the liquid phase components.

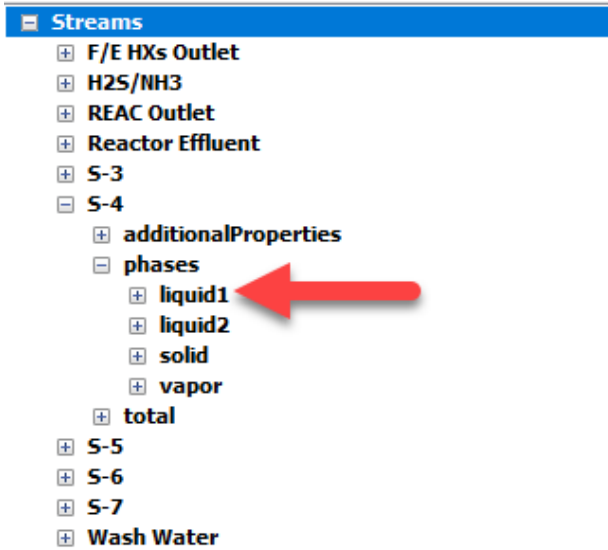

Now expand "liquid1" which is the traditionally water-rich (aqueous) phase.

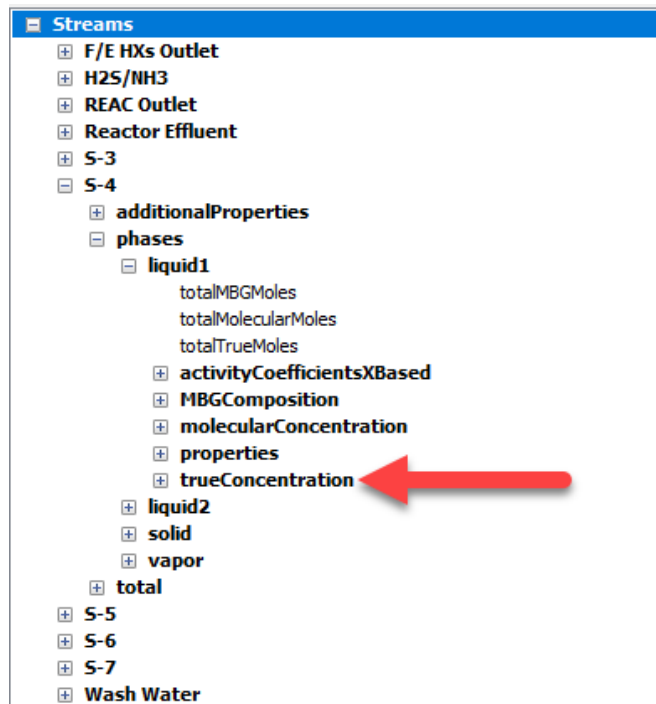

Now expand "trueConcentration" to see the actual or true species. This differs from what is called "molecularConcentration" which is defined in other OLI documents.

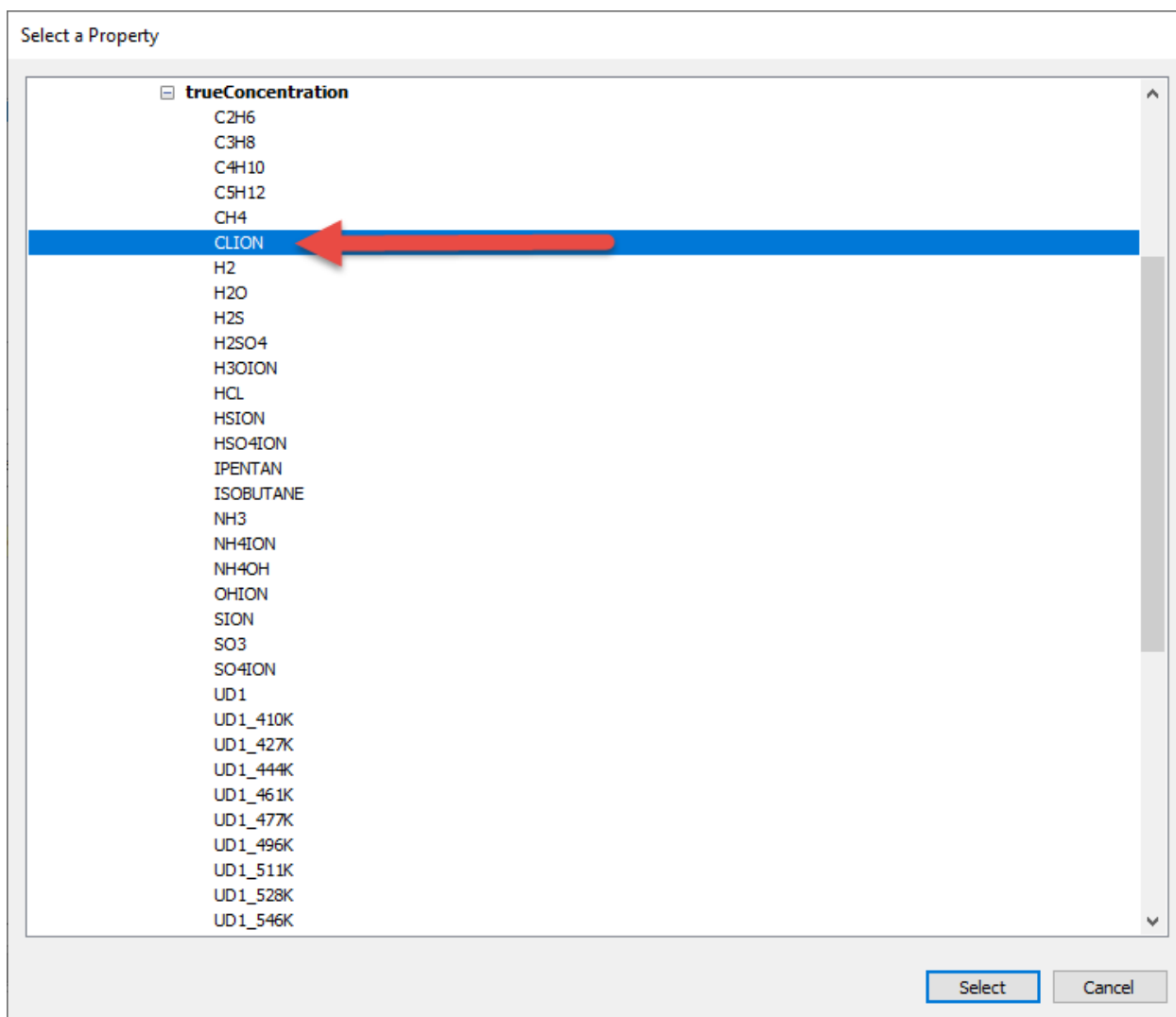

Select all the species that contain a chloride ion. Fortunately for this example, only one species contains the chloride ion and that is CLION⁵

Press the **Select** button.

⁵ The syntax here is the OLI Tag name. This can be confusing to sort out if the species is heavily renamed. You can use the OLI Data Locator to help you sort out the name. This limitation will be relieved in future versions.

Specify selected objective function expression

Minimize Maximize

Define properties or subexpressions for use in the above expression

↑↓	Type	Name	Value	Units	
	Property	Chlorides	['S-4']['phases']['liquid1']['trueConcentration']['values']['CLION'] ...	lb/hr	⊖
	Subexpression				

↑
↓

We have just entered our first variable. We will use the default unit set which is derived from the document.

Please repeat the steps for a new property called “Salts.” Here we just outline the steps:

- Change the **Type** drop-down box to Property
- Enter the name “Salts”
- Click the “...” button
- Select Stream “S-4”
- Select “Phases”
- Select “Solid”
- Select “properties”
- Select “mass”
- Click the **Select** button

The panel should look like this:

Specify selected objective function expression

Minimize Maximize

Define properties or subexpressions for use in the above expression

↑↓	Type	Name	Value	Units	
	Property	Chlorides	['S-4']['phases']['liquid1']['trueConcentration']['values']['CLION'] ...	lb/hr	⊖
	Property	Salts	['S-4']['phases']['solid']['properties']['mass'] ...	lb/hr	⊖
	Subexpression				

↑
↓

You will now enter your sub-expression. This is very simple; it is a function of the properties you have just defined. You can also perform mathematical operations in the sub-expressions, but you will need to see a list of supported functions. See Appendix-2

Enter a subexpression for **Total = Chlorides+Salts**; when done, your panel should look like this:

Specify selected objective function expression

Minimize Maximize

Define properties or subexpressions for use in the above expression

↑↓	Type	Name	Value	Units	
	Property	Chlorides	<code>['S-4']['phases']['liquid1']['trueConcentration']['values']['CLION']</code> ...	lb/hr	⊖
	Property	Salts	<code>['S-4']['phases']['solid']['properties']['mass']</code> ...	lb/hr	⊖
	Subexpression	Total	Chlorides+Salts		⊖
	Subexpression				⊖

↑
↓

A few notes here: if you made a mistake in your property values, you can edit them via the “...” button. If you want to delete them, click the red , and the value is deleted.

The sub-expression is order-dependent. That means all variables that the expression use must be previously defined above the expression. There is no “Insert” function, so if you missed a variable, you need to add it to the end of the list and then use the arrows on the right to move them as needed.

The final step on this panel is to enter the objective function expression.

Specify selected objective function expression

Minimize Maximize

Define properties or subexpressions for use in the above expression

↑↓	Type	Name	Value	Units	
	Property	Chlorides	<code>['S-4']['phases']['liquid1']['trueConcentration']['values']['CLION']</code> ...	lb/hr	⊖
	Property	Salts	<code>['S-4']['phases']['solid']['properties']['mass']</code> ...	lb/hr	⊖
	Subexpression	Total	Chlorides+Salts		⊖
	Subexpression				⊖

↑
↓

You could have entered the value "Chlorides+Salts" directly into the input field instead of “Total,” eliminating the need to create a separate sub-expression “Total.” However, using a sub-expression is recommended when troubleshooting or validating your process, as it offers greater transparency and flexibility during debugging.

We are not yet done; we need to define the variables that will be adjusted, which will be the “Wash Water” flow rate.

Enable optimizer

Enable optimizer in the simulation

Edit objective functions

Objective 1 - Minimize "Total"

Add

Remove

Specify selected objective function expression

Minimize Maximize Total

Define properties or subexpressions for use in the above expression

ID	Type	Name	Value	Units
	Property	Chlorides	['S-4']['phases']['liquid']['trueConcentration']['values']['CLION']	lb/hr
	Property	Salts	['S-4']['phases']['solid']['properties']['mass']	lb/hr
	Subexpression	Total	Chlorides+Salts	
	Subexpression			

Click on the **Variables** tab.

Objectives Variables Convergence Results

Edit optimizer variables

Add

Remove

Define selected variable

Type Free Fixed

Object

Variable

Units

Initial Value

Minimum Value

Maximum Value

Initial Step Size

This is the panel where we define the variables that will be adjusted during the optimize process. We will go through each option in turn.

Click the **Add** button

Define selected variable

Type Free Fixed

Object <Select>

Variable

Units

Initial Value

Minimum Value

Maximum Value

Initial Step Size

When the “add” button is clicked, the parameters become live. The parameters can be “Free” which means the parameter will be adjusted or “Fixed” which means the parameter is a set value. Normally this option is set to “Free.”

Click the drop-down box next to object to select the type of parameter.

Define selected variable

Type Free Fixed

Object <Select>

Variable <Select>

Units

Initial Value

Minimum Value

Maximum Value

Initial Step Size

You can select block parameters such as duty or stream parameters such as flow (which is what we will do in this example). You can also adjust thermodynamic parameters which will be discussed on our support center page.

Select **Stream**.

Define selected variable

Type Free Fixed

Object Stream <Select>

Variable

Units

Initial Value

Minimum Value

Maximum Value

Initial Step Size



You can now select from any stream in the process. We will use the “Wash Water” stream. Click the drop-down box to find and select “Wash Water”

Define selected variable

Type Free Fixed

Object Stream <Select>

Variable

Units

Initial Value

Minimum Value

Maximum Value

Initial Step Size

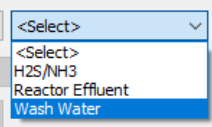

There are several parameters unique to the stream variable.

Define selected variable

Type Free Fixed

Object Stream Wash Water

Variable <Select>

Units

Initial Value

Minimum Value

Maximum Value

Initial Step Size



From this drop-down list find and select “Total Flow.”

Define selected variable

Type Free Fixed

Object Stream Wash Water

Variable <Select>

Units <Select>

Initial Value <Select>

Minimum Value <Select>

Maximum Value <Select>

Initial Step Size <Select>

Total Flow
Pressure
Temperature
C2H6
C3H8
CH4
H2
H2O
H2S
HCl
Hydrotreated Diesel
i-C4H10
i-C5H12
n-C4H10
n-C5H12
NH3

We are now ready to enter some initial values and boundary conditions.

Define selected variable

Type Free Fixed

Object Stream Wash Water

Variable Total Flow

Units lb/hr

Initial Value

Minimum Value <Auto>

Maximum Value <Auto>

Initial Step Size <Auto>

- 1) The units are pulled from the actual units for the stream. These can be changed, within reason, to other units. For this example, we will use the default value.
- 2) We need an initial value. This is the initial value for the "Wash Water" stream. Currently, this value is 1500 lb/hr (review the flowsheet), but you can set it to whatever value is required. Enter 2000 for this value.
- 3) We know that at 1500 lb/hr there are solids so we should not need to go below this value. For our example, let's be sure and set this minimum value to 1000
- 4) We are sure that the solids will be dissolved with 8000 lb/hr of wash water so we do not need to go above this value. Enter 8000.
- 5) Steps, please leave this set to auto. The panel should now look like this:

Define selected variable

Type Free Fixed

Object Stream Wash Water

Variable Total Flow

Units lb/hr

Initial Value 2000.0

Minimum Value 1000.0

Maximum Value 8000.0

Initial Step Size <Auto>

We are almost done.

Objectives Variables Convergence Results

Edit optimizer variables

Wash Water: Total Flow

Add

Remove

Define selected variable

Type Free Fixed

Object Stream Wash Water

Variable Total Flow

Units lb/hr

Initial Value 2000.0

Minimum Value 1000.0

Maximum Value 8000.0

Initial Step Size <Auto>



Click on the **Convergence** tab.

Objectives	Variables	Convergence	Results
Convergence Options			
Convergence Algorithm		BOBYQA	
Max. Iterations		100	
<input type="checkbox"/> Enable function scaling			
Stopping Criteria			
Stopping Criterion 1			
Stopping Criterion Type		Rel Tol on Function Value	
Stop when function value is within specified relative tolerance.			
Value		0.01	
Add another			
Advanced Options			
<input type="checkbox"/> Run affected blocks only (experimental)			

Here is where the conditions for convergence are set for the optimizer.

Convergence Options

The first parameter is **Convergence Algorithm** which must be specified. Currently, the only algorithm that can be used is BOBYQA.

What is BOBYQA? Simply put, BOBYQA is an iterative algorithm for finding a minimum of a function $F(x), x \in R^n$, subject to the simple bounds

$$a_i \leq x_i \leq b_i, \quad i = 1, 2, 3, \dots, n$$

on the variables, F being specified by a “black box” that returns the value $F(x)$ for any feasible x . Each iteration employs a quadratic approximation Q to F that satisfies

$$Q(y_j) = F(y_j), \quad j = 1, 2, 3, \dots, m$$

the interpolation points y_j being chosen and adjusted automatically, but m is a prescribed constant. These conditions leave much freedom in Q , taken up when the model is updated by the highly successful technique of minimizing the Frobenius norm of the change to the second derivative matrix of Q . Thus, no derivatives of F are required explicitly. Most changes to the variables are an approximate solution to a trust region subproblem, using the current quadratic model, with a lower bound on the trust region radius that is reduced cautiously, to keep the interpolation points well separated until late in the calculation, which lessens damage from computer rounding errors. The name **BOBYQA** is an acronym for **Bound Optimization BY Quadratic Approximation.**

Max Iterations is the maximum number of iterations the optimizer will use to reach convergence. It defaults to 100.

Stopping Criteria

This defines convergence. You may have more than one stopping criterion if you have more than one objective function. Select the **Stopping Criterion Type** “Rel Tol on Function Value.”

Objectives	Variables	Convergence	Results
Convergence Options			
Convergence Algorithm		BOBYQA	
Max. Iterations		100	
<input type="checkbox"/> Enable function scaling			
Stopping Criteria			
Stopping Criterion 1			
Stopping Criterion Type		Rel Tol on Function Value	
Stop when function value is within specified re		Stop at Objective Value	
Value		Rel Tol on Function Value	
		Abs Tol on Function Value	
		Rel Tol on Free Variable(s)	
Add another			
Advanced Options			
<input type="checkbox"/> Run affected blocks only (experimental)			

Each of these values is straightforward to define.

$$\text{Rel Tol on Function Value} = \left| \frac{\text{Current Value} - \text{Previous Value}}{\text{Previous Value}} \right|$$

$$\text{Abs Tol on Function Value} = |\text{Current Value} - \text{Previous Value}|$$

$$\text{Relative Tol on Free Value} = \left| \frac{\text{Current Free Value} - \text{Previous Free Value}}{\text{Previous Free Value}} \right|$$

If the value that is calculated is less than the specified value, then the optimizer has converged. Each type has its place in optimization. The “Rel Tol on Function Value” is the most common. This looks for a fractional change in the calculated function value. This is useful when your function has a very large dynamic range of values.

The “Abs Tol on Functional Value” is for the absolute difference between two iterations in the optimizer. This is useful when tight tolerances are required, and the dynamic range of the calculated functions is small.

The “Relative Tol on Free Value” is useful when a free type of optimizer function is used. This is infrequently used.

The default value is 0.01, which is suitable for this example.

Running the optimizer

The optimizer is completely set up. You can now run the simulation.

After the run converges, you will see the output screen:

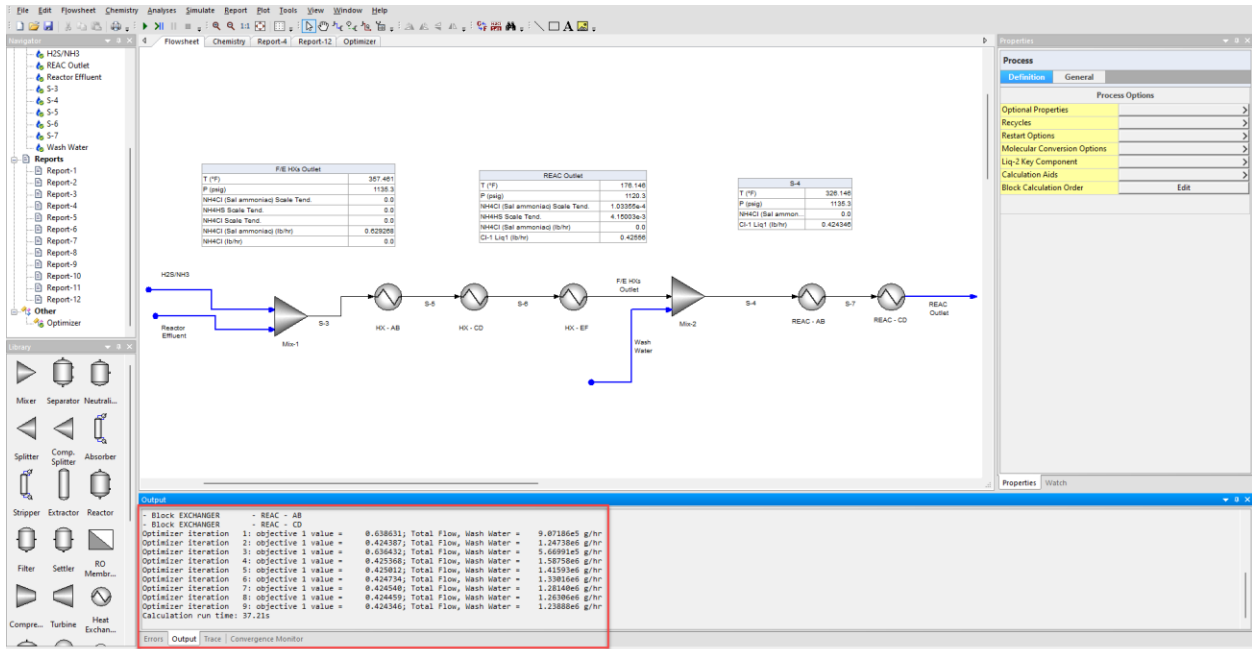

The output panel shows the trace of the optimizer. To see the results, click back on the optimizer tab:

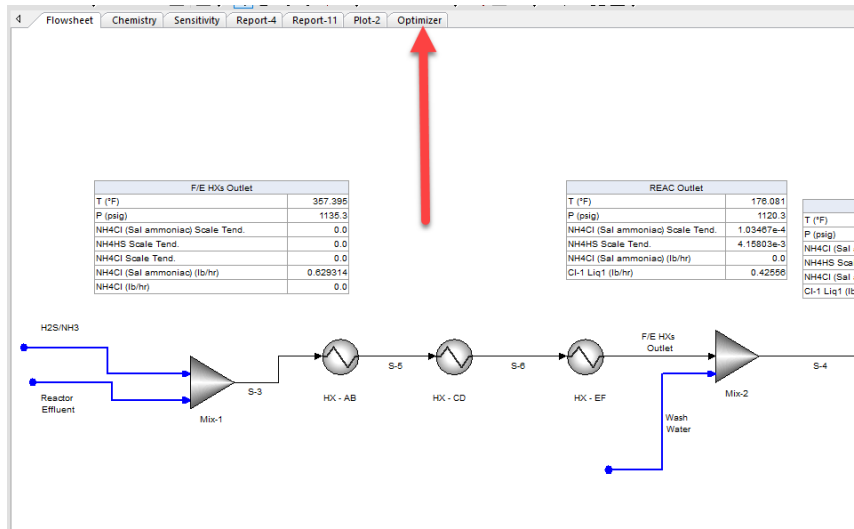

You will probably be returned to the panel you left when you ran the simulation:

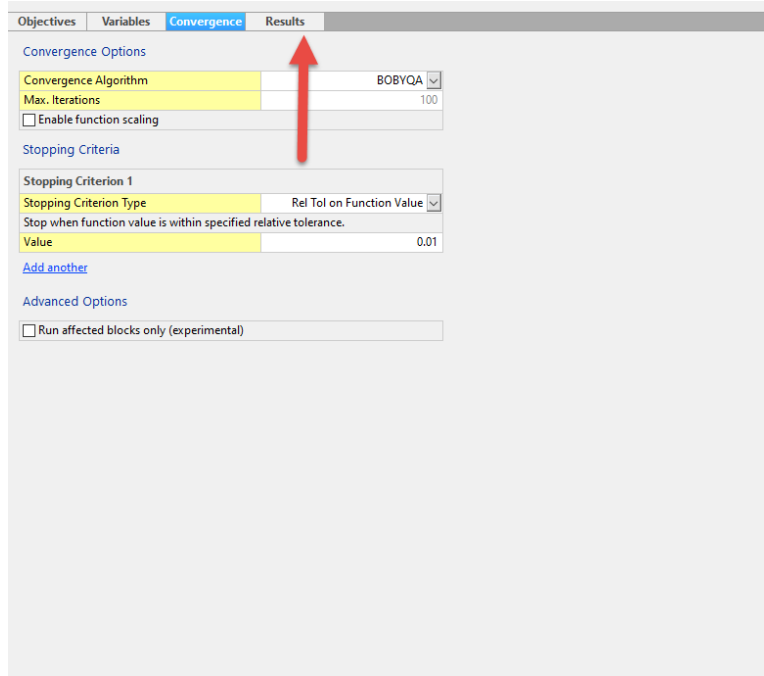

Click the results tab:

Objectives	Variables	Convergence	Results
Customize Export...			
Optimizer Calculation Results			
Objectives			
Objective 1 - Minimize: Total			
Chlorides	['S-4']['phases']['liquid']['trueConcentra...		lb/hr
Salts	['S-4']['phases']['solid']['properties']['mas...		lb/hr
Total	Chlorides+Salts		
Initial Value	0.638631	1	
Final Value	0.424353		
Flowsheet Variables			
<i>You can use the "Update" button to update the specified flowsheet spec. with the calculated value.</i>			
Wash Water: Total Flow (lb/hr)			
Initial Value	2000.0		
Final Value	2731.25	Update	2
Convergence Details			
Status	Converged		
Num. Iterations	9		

- 1) #1 shows the initial value of the objective function (approximately 0.639) and the final value of the objective function (0.424). This can help you determine if you used the correct objective function.
- 2) #2 shows the initial value of the objective variable (the stream "Wash Water" flow rate), which was 2000 lb/hr, and the final value of 2731.25 lb/hr. This is the minimum flow rate necessary to minimize the amount of chlorides and solids in the stream "S-4."

The **Update** button will automatically update the variable in the stream "Wash Water." At that point, the optimizer analysis can be disabled so further studies can be made.

Final Note:

During the development of this example, the authors ran into non-convergence issues. This was debugged to find that spelling and capitalization count. The authors used the word “Chlorides” in the Property field but the misspelled word “Chorides” in the sub-expression. A future version will trap this spelling error.

A more insidious error is that the Property Field “Salts” was represented as “salts” in the subexpression. This was taken to be a new variable and caused convergence errors. When the spelling and capitalization errors were fixed, the program converged.

Chapter VII – Case Library

The Case Library gives the user access to several detailed cases that are built into the program and contains 60+ flowsheet cases that are part of different industries.

To access the **Case Library**, select **File** from the menu and then **Case Library**

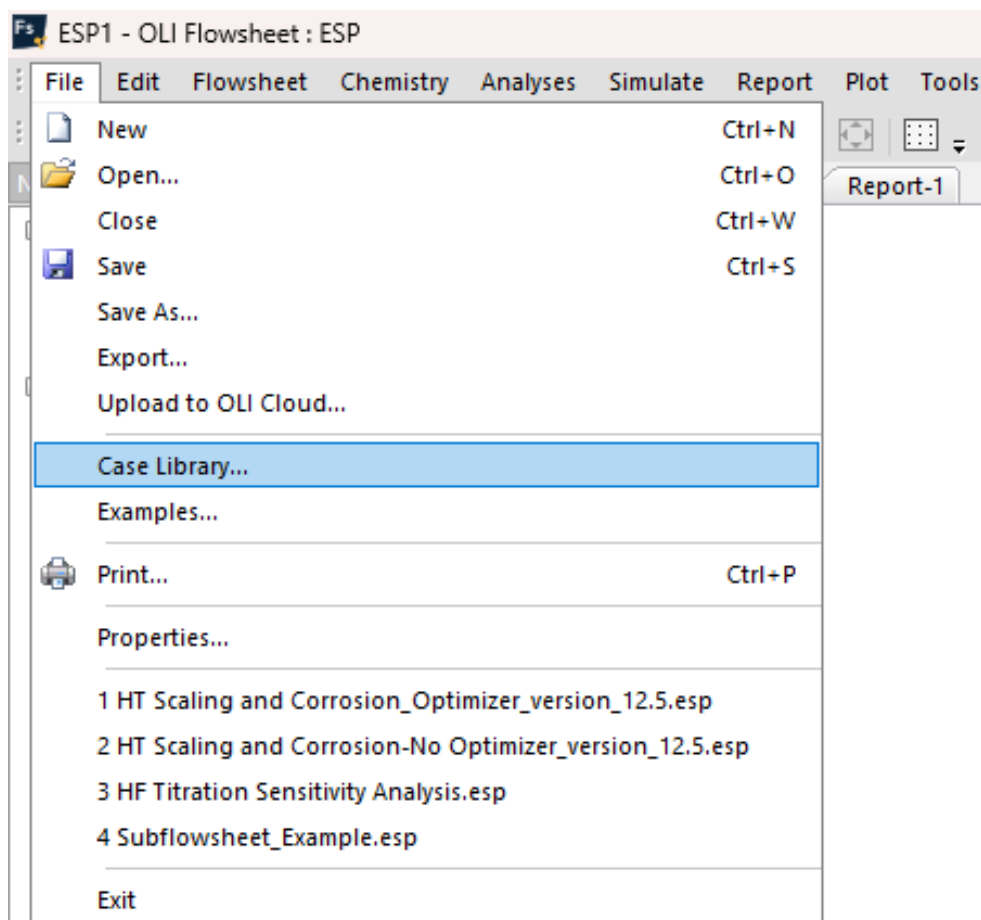

This will display the Case Library menu

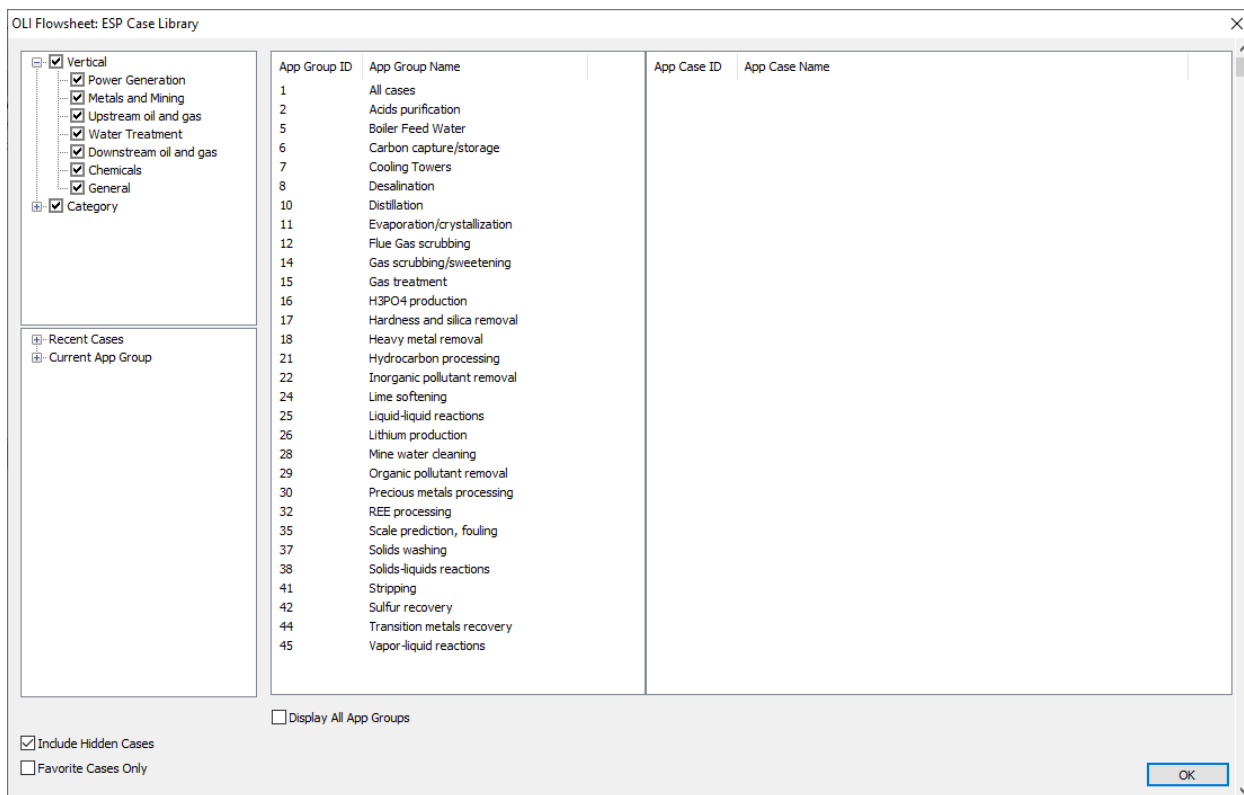

We will discuss each panel individually.

Category

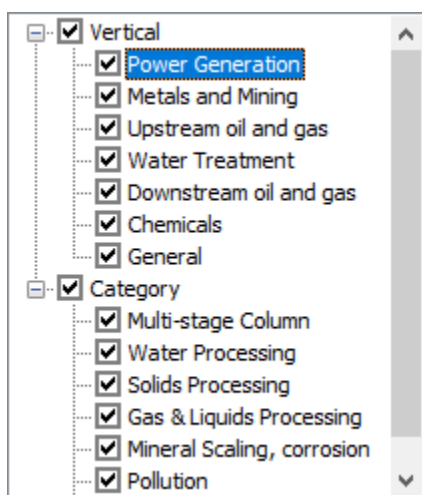

This panel is affected by your license. If you or your organization only licensed a subset of database segments, then some of these verticals will not be displayed.

This panel shows the different industry verticals that contain examples. Uncheck these verticals if you do not want to search them. The panel also shows the case files by the type of application.

The screenshot shows a software interface with two main panels. On the left is a tree view with a 'Vertical' section containing several sub-items, and a 'Category' section below it. On the right is a table with two columns: 'App Group ID' and 'App Group Name'.

Tree View:

- Vertical
 - Power Generation
 - Metals and Mining
 - Upstream oil and gas
 - Water Treatment
 - Downstream oil and gas
 - Chemicals
 - General
- Category
 - Multi-stage Column
 - Water Processing
 - Solids Processing
 - Gas & Liquids Processing
 - Mineral Scaling, corrosion
 - Pollution

Table:

App Group ID	App Group Name
1	All cases
14	Gas scrubbing/sweetening
15	Gas treatment
21	Hydrocarbon processing
25	Liquid-liquid reactions
41	Stripping
42	Sulfur recovery

Below the tree view, there are two expandable sections: 'Recent Cases' and 'Current App Group'.

The Application group is displayed next to the vertical/category panel. You can see in the example that only the **Downstream oil and gas** vertical has been selected, so only those case files are displayed.

For this example, we will select group **41 Stripping** to see what happens.

App Group ID	App Group Name	App Case ID	App Case Name
1	All cases	204	Seawater Deaerator - Equilibrium Stage colum
14	Gas scrubbing/sweetening	205	Seawater Deaerator - Sieve Tray column
15	Gas treatment	207	Rich Amine Regenerator
21	Hydrocarbon processing	208	Methanol removal from crude
25	Liquid-liquid reactions		
41	Stripping		
42	Sulfur recovery		

You can see that case files pertaining to “Stripping” are now displayed.

For this example, we will select “207 Rich Amine Regenerator”

OLI Flowsheet: ESP Case Library

- Vertical
 - Power Generation
 - Metals and Mining
 - Upstream oil and gas
 - Water Treatment
 - Downstream oil and gas
 - Chemicals
 - General
- Category

- Recent Cases
 - CaseID: 207
- Current App Group
 - CaseID: 204
 - CaseID: 205
 - CaseID: 207
 - CaseID: 208
 - CaseID: 602

[Back](#)

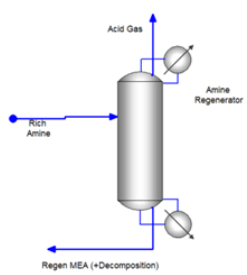

Application Case Information:

Application Case ID	207
Title	Rich Amine Regenerator
Associated App Groups	1. All cases 14. Gas scrubbing/sweetening 15. Gas treatment 41. Stripping
Associated Verticals	Downstream oil and gas
Associated Categories	Gas & Liquids Processing
Brief Description	Amine regeneration unit using equilibrium stages
Keywords	Gas processing, gas sweetening, amines, sour gas
Date Created	Jan 1, 2021

Set Case Hidden
 Set Case Favorite

This panel now displays some additional information about this case. There is information below this panel so scrolling down is required.

OLI Flowsheet: ESP Case Library

- Vertical
 - Power Generation
 - Metals and Mining
 - Upstream oil and gas
 - Water Treatment
 - Downstream oil and gas
 - Chemicals
 - General
- Category

- Recent Cases
 - CaseID: 207
- Current App Group
 - CaseID: 204
 - CaseID: 205
 - CaseID: 207
 - CaseID: 208
 - CaseID: 602

Application Case Information:

Application Case ID	207
Title	Rich Amine Regenerator
Associated App Groups	1. All cases 14. Gas scrubbing/sweetening 15. Gas treatment 41. Stripping
Associated Verticals	Downstream oil and gas
Associated Categories	Gas & Liquids Processing
Brief Description	Amine regeneration unit using equilibrium stages
Keywords	Gas processing, gas sweetening, amines, sour gas
Date Created	Jan 1, 2021
Industry / Application	Oil and Gas / Gas sweetening, amine units, gas processing
Details	Rich diethanolamine is sent to an eight-stage stripper column that removes H ₂ S and CO ₂ . The column uses eight equilibrium stages with a 100% Murphree efficiency. Two Spec/Controls is included to fix the H ₂ S exiting the bottom of the column. The other Spec/Control fixes the H ₂ O vapor exiting the column overhead.
Available Adjustments	Rich amine composition, flow and temperature Regenerator bottom tray targets Regenerator top tray targets Regenerator pressure
Constraints	Kinectics are off Oxidation/reduction is off Amine degradation equation in the O ₂ deg unit Amine degradation equation in the CO ₂ deg unit
Process Blocks	Stripper - eight eq. stages, reboiler, condenser
Units Manager	Default: Metric-Flowing (hr, kg, m3, C, atm)
Chemistry	MSE No additional databases. No sub models H ₂ O, CH ₄ , CO ₂ , H ₂ S, Ar, C ₂ H ₆ , C ₃ H ₈ , n-C ₄ H ₁₀ , i-C ₄ H ₁₀ , HN(C ₂ H ₄ OH) ₂ , O ₂ , C ₂ H ₄ O ₂ , (COOH) ₂ , CO, NH ₃ , C ₆ H ₅ OH, HCN, CH ₃ SH, C ₂ H ₆ S, C ₃ H ₈ S
Meets Standards	None
Comments	No comments

Set Case Hidden
 Set Case Favorite

After scrolling down, you can read more information about this case.

To use this case as is, click the **Open** button. To see a different case and return to the library, click the **Back** hyperlink.

After clicking the **Open** button, you will need to close the Case Library.

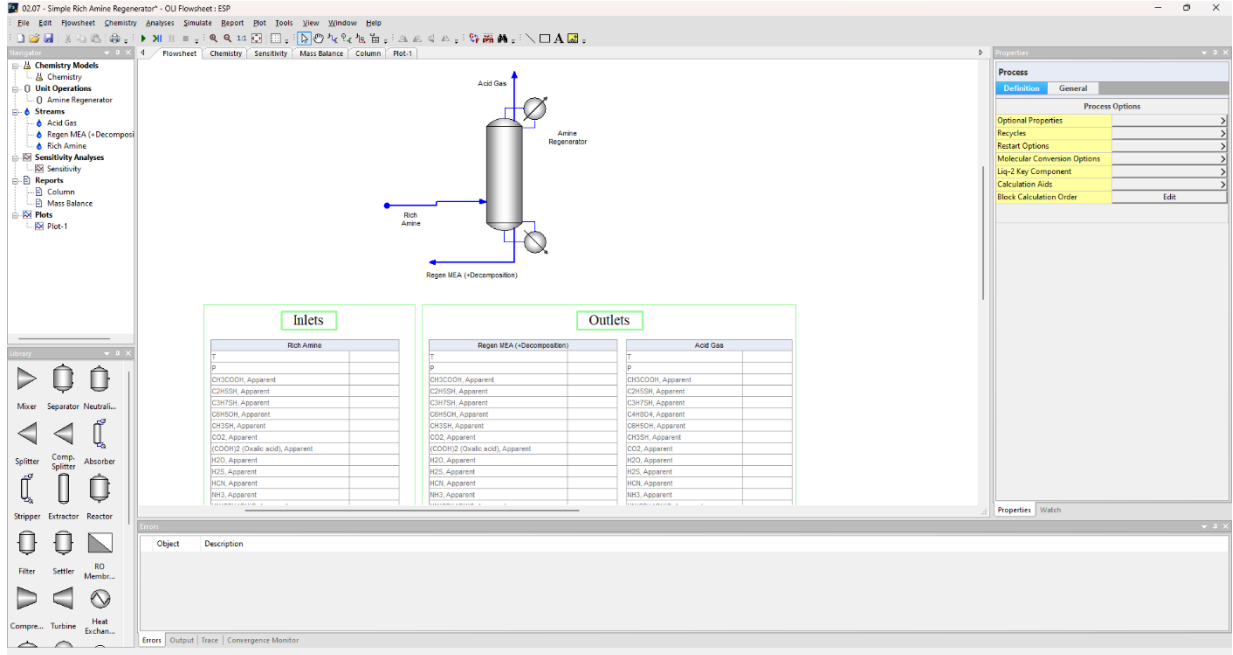

This will open the template with cleared results. This is a saved file in the system, and you cannot overwrite it. Clicking Save will open a new Save As dialog.

Chapter VIII – Process Applications

In this section, we will have examples of various process applications that illustrate the use of the unit operations in OLI Flowsheet: ESP.

Reactor Block Examples

Standard Reaction Kinetics

This example shows the implementation of standard reaction kinetics. It is about the hydrolysis of urea. Create a new flowsheet with the following input chemistry using the default MSE thermodynamic framework.

Species	Formula	OLI Tag Name
Water	H ₂ O	H2O
Carbon dioxide	CO ₂	CO2
Ammonia	NH ₃	NH3
Urea	NH ₂ CONH ₂ ⁶	UREA

When complete, your chemistry model section should look like the following:

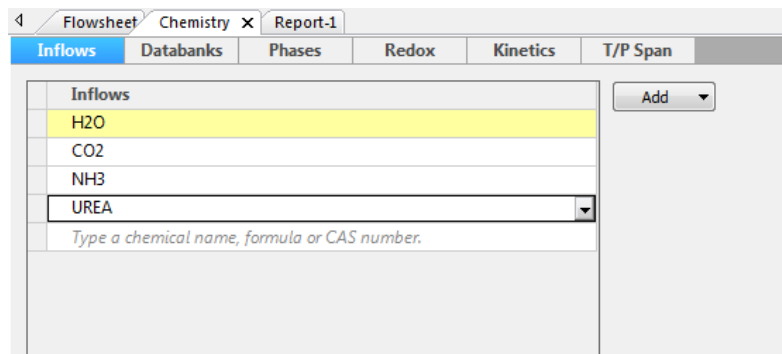

Click on the **Kinetics** tab.

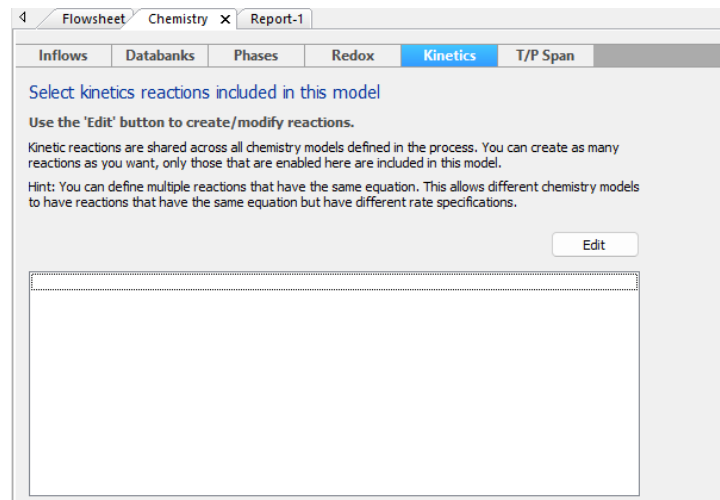

⁶ This may also be represented as CH₄N₂O

This will display the reaction kinetics editor. Now, there is nothing displayed.

Click the **Edit** button.

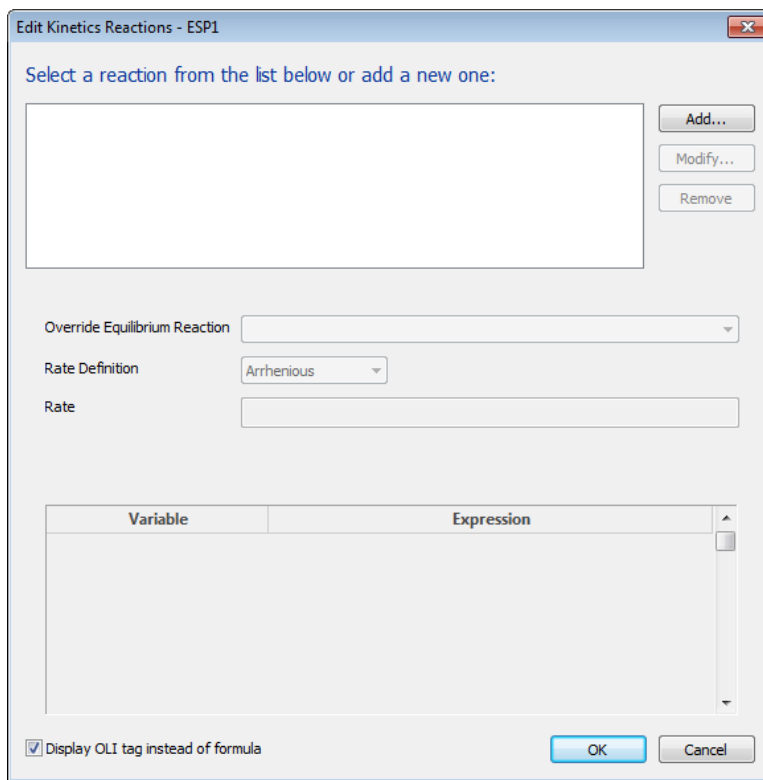

This is the reaction kinetics editor. To add the hydrolysis of urea, we need to click the **Add** button.

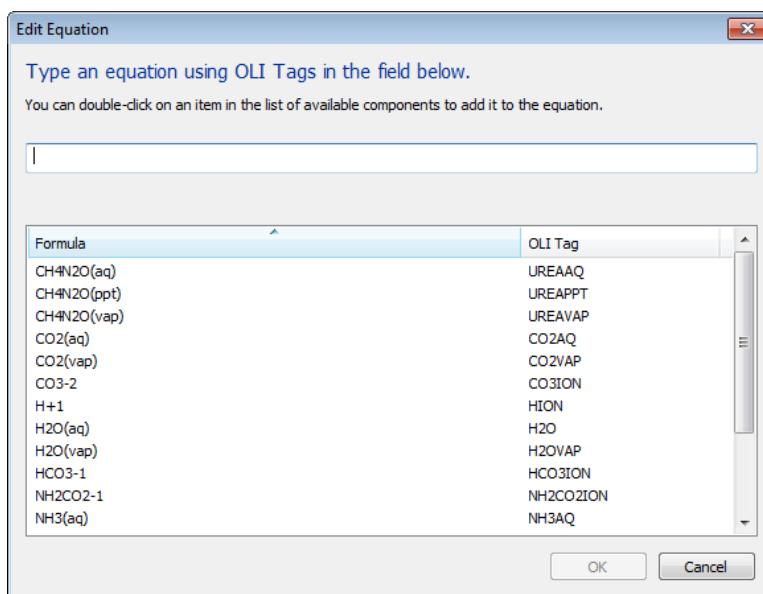

These are all the components currently in the chemistry model. Our reaction equation must contain these species. The reaction we want is the following:

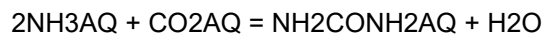

Let's start by locating NH3(AQ) from the list:

Formula	OLI Tag
CO3-2	CO3ION
H+1	HION
H2O(aq)	H2O
H2O(vap)	H2OVAP
HCO3-1	HCO3ION
NH2CO2-1	NH2CO2ION
NH3(aq)	NH3AQ
NH3(vap)	NH3VAP
(NH4)2CO3.2NH4HCO3(ppt)	NH44H2CO33PPT
NH4+1	NH4ION
NH4HCO3(ppt)	NH4HCO3PPT
OH-1	OHION

Double-click the component to add it to the equation.

Edit Equation

Type an equation using OLI Tags in the field below.
You can double-click on an item in the list of available components to add it to the equation.

NH3AQ

The entered expression is not a valid equation.

Formula	OLI Tag
---------	---------

You can see that we have entered the component, but there is an error message. This is ok for now since we haven't completed the equation. We now need to add the plus sign "+" to add the next component:

Edit Equation

Type an equation using OLI Tags in the field below.
You can double-click on an item in the list of available components to add it to the equation.

NH3AQ +

The entered expression is not a valid equation.

Now locate CO2(AQ) from the list and add it in the same manner. After that, complete the equation so it looks like the following:

Edit Equation

Type an equation using OLI Tags in the field below.
You can double-click on an item in the list of available components to add it to the equation.

NH3AQ + CO2AQ = UREAAQ + H2O

The specified equation does not mass balance.

There seems to be a problem. The program will check to see if the equation mass-balances and in this case, it does not. This is because it takes two molecules of ammonia to make urea. You can add the "2" in front of the NH3AQ variable:

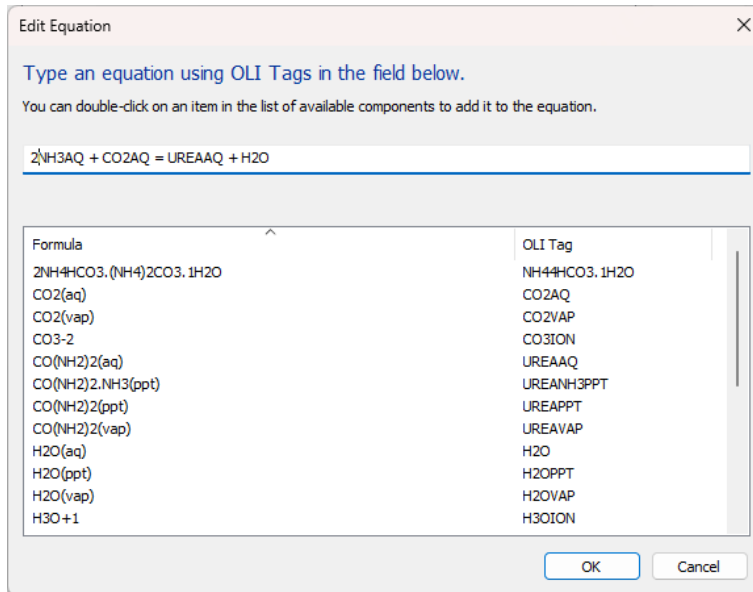

Click the OK button to close the editor.

We now have a reaction in the model. We now must change some constants which we get from literature.

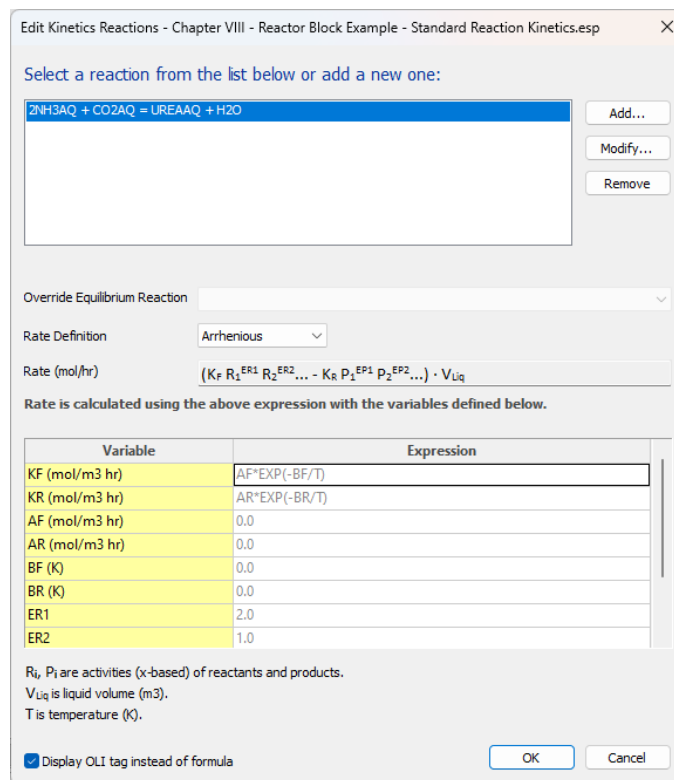

We do have some data to enter. The rate function has been determined to be:

$$Rate = K_f [NH_3]^2 [CO_2] - K_r [NH_2CONH_2]$$

Where:

Rate [moles/hr]

K_f = forward reaction equilibrium constant = 20

[a] = concentration of species a

K_r = reverse reaction equilibrium constant determined by Arrhenius Equation

$$K_f = 1.2E - 06 \text{ EXP}[-28939.9/8.3142 \times T]$$

Thus,

$$BR = -(-28939.9/8.3142) = 3480.78$$

Edit Kinetics Reactions - Chapter VIII - Reactor Block Example - Standard Reaction Kinetics.esp

Select a reaction from the list below or add a new one:

2NH3AQ + CO2AQ = UREAQ + H2O

Buttons: Add..., Modify..., Remove

Override Equilibrium Reaction: [dropdown]

Rate Definition: Arrhenius

Rate (mol/hr): $(K_f R_1^{ER1} R_2^{ER2} \dots - K_r P_1^{EP1} P_2^{EP2} \dots) \cdot V_{Liq}$

Rate is calculated using the above expression with the variables defined below.

Variable	Expression
KF (mol/m3 hr)	20.0
KR (mol/m3 hr)	AR*EXP(-BR/T)
AF (mol/m3 hr)	0.0
AR (mol/m3 hr)	1.2e-6
BF (K)	0.0
BR (K)	3480.78
ER1	2.0
ER2	1.0

R_i, P_i are activities (x-based) of reactants and products.
 V_{Liq} is liquid volume (m3).
 T is temperature (K).

Display OLI tag instead of formula

Buttons: OK, Cancel

Scroll down to enter EP2

Variable	Expression
BF	0.0
BR	3480.78
ER1	2.0
ER2	1.0
EP1	1.0
EP2	0.0

A red arrow points to the EP2 row in the table.

Click **OK** when done.

Now enable the added reaction kinetics.

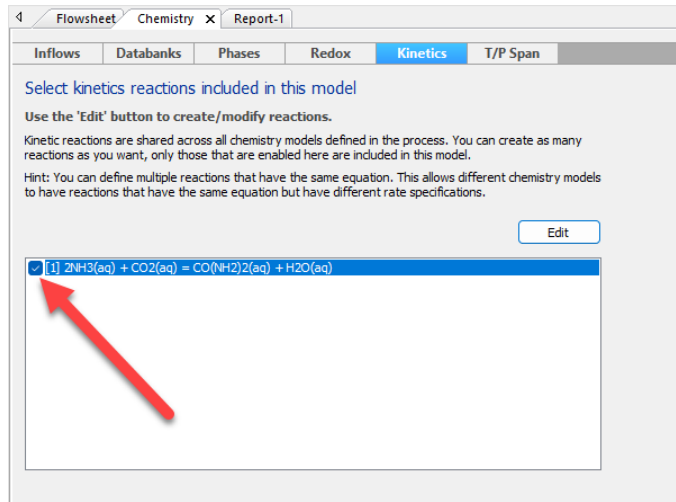

Check the box if it is not already checked.

Now click on the **Flowsheet** tab to begin entering the blocks and streams.

Create a flowsheet with a reactor block with a single feed stream and a single product stream such as the following:

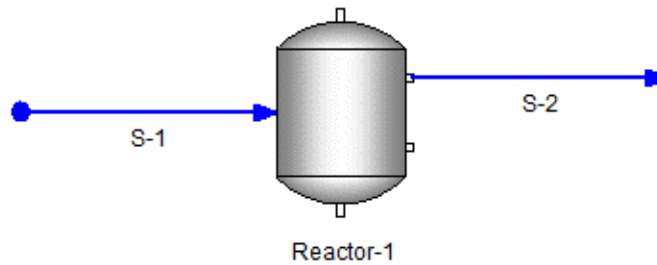

Enter the following feed parameters given in the table below:

Feed Stream Parameters	
Feed Stream Name	S-1
Temperature	25 °C
Pressure	1 atm
Total Flow	100 mol/hr
H2O	1.0 mol/hr
CO2	0.1 mol/hr
NH3	0.35 mol/hr
Urea	0.0 mol/hr

Enter the following reactor block parameters given in the table below:

Reactor Block Parameters	
Reactor Type	Kinetics
Kinetic Parameters <i>(flyout dialog)</i>	
Number of Stages	10
Residence Time (hr)	100
Calculation Type	Isothermal
Pressure Spec.	Min. Inlet Pressure
Temperature (°C)	35.0
Chemistry Model	Default

Once entered, run the process and then review the output. We have added callouts to show you the formation of urea (albeit a small amount).

To add callouts, right-click on the streams and select add callout.

Your simulation should look like the image below:

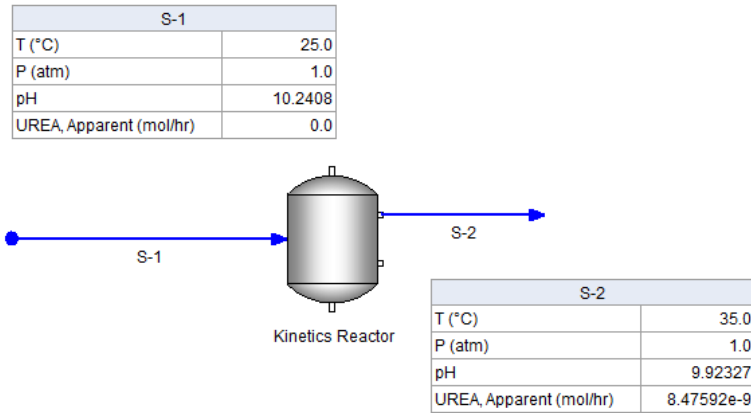

Non-Standard (User Defined) Reaction Kinetics

In this example, we are using non-standard reaction kinetics to hydrolyze ammonia. The overall reaction is:

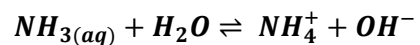

We know the forward rate constant (and hence the forward reaction rate), but we wish to constrain the forward and reverse reaction rates to the thermodynamic equilibrium constant stored in the OLI Databases.

Create a chemistry section with the following information:

Non-Standard Reaction Kinetics		
Thermodynamic Framework	MSE (H3O+ Ion)	
Additional Databanks	None	
Phases	Default	
Redox	Off	
Inflows	Formula	OLI Tag Name
Water	H ₂ O	H2O
Ammonia	NH ₃	NH3

Using the techniques from the previous section, add the kinetics reaction for the reaction shown above.

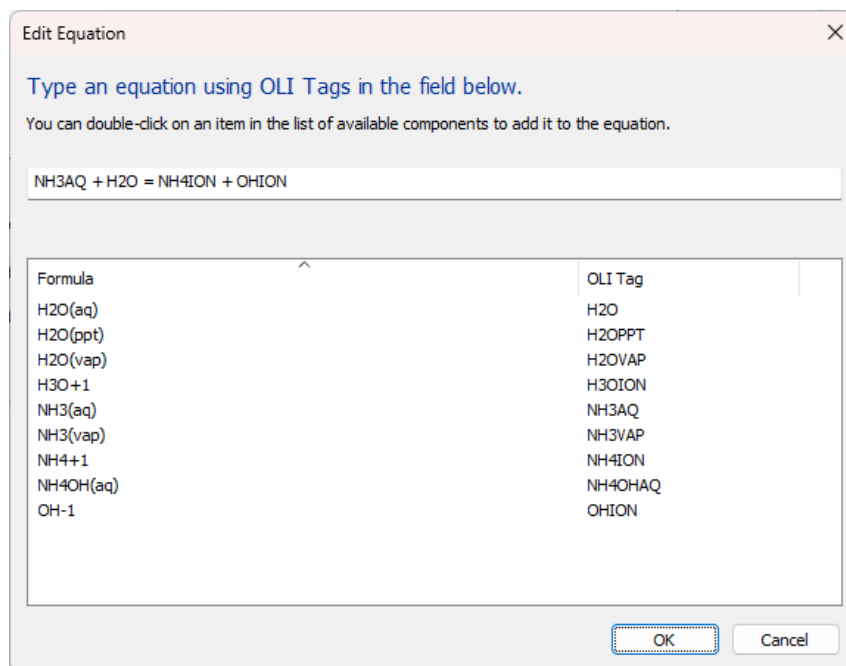

The reaction mechanism has been previously determined. It is beyond the scope of the document to instruct you how to determine that mechanism, only to add the mechanism to the program.

$$R_f = k_f \gamma_{NH_3(aq)} [NH_3(aq)] \gamma_{H_2O} [H_2O]$$

$$R_r = k_r \gamma_{NH_4^+} [NH_4^+] \gamma_{OH^-} [OH^-]$$

Where,

$$k_f = 3$$

$$k_r = \frac{k_f}{K_{eq}}$$

Thus, the rate can be defined as:

$$rate = (k_f e^{R_f} - k_r^{R_r}) \times \frac{volume}{100}$$

We now need to turn these values into “OLI” terms.⁷

FXRATE=LNH3AQ+ANH3AQ+LH2O+AH2O

RXRATE=LNH4ION+ANH4ION+LOHION+AOHION

KF1=3

KR1=KF1/KEQ

RATE=(KF1*EXP(FXRATE)-KR1*EXP(RXRATE)) *VOLLIQ/1000.

Clicking OK will return you to the editor:

⁷ Commonly referred to as ASAP variables.

Edit Kinetics Reactions - Non-Standard Kinetics Example.esp

Select a reaction from the list below or add a new one:

[1] NH3AQ + H2O = NH4ION + OHION

Add...
Modify...
Remove

Override Equilibrium Reaction: NH3AQ + H2O = NH4OHAQ

Rate Definition: Arrhenius

Rate (mol/hr): $(K_F R_1^{ER1} R_2^{ER2} \dots - K_R P_1^{EP1} P_2^{EP2} \dots) \cdot V_{Liq}$

Rate is calculated using the above expression with the variables defined below.

Variable	Expression
KF (mol/m3 hr)	AF*EXP(-BF/T)
KR (mol/m3 hr)	AR*EXP(-BR/T)
AF (mol/m3 hr)	0.0
AR (mol/m3 hr)	0.0
BF (K)	0.0
BR (K)	0.0
ER1	1.0
ER2	1.0

R_i, P_i are activities (x-based) of reactants and products.
V_{Liq} is liquid volume (m3).
T is temperature (K).

Display OLI tag instead of formula

OK Cancel

You will notice that we are replacing an existing equilibrium equation with reaction kinetics (unlike the previous example where we created a new equation).

Override Equilibrium Reaction: NH3AQ + H2O = NH4OHAQ

Rate Definition: Arrhenius

The reaction kinetics we have for this example are not Arrhenius. Change the **Rate Definition** selection to **User Defined**.

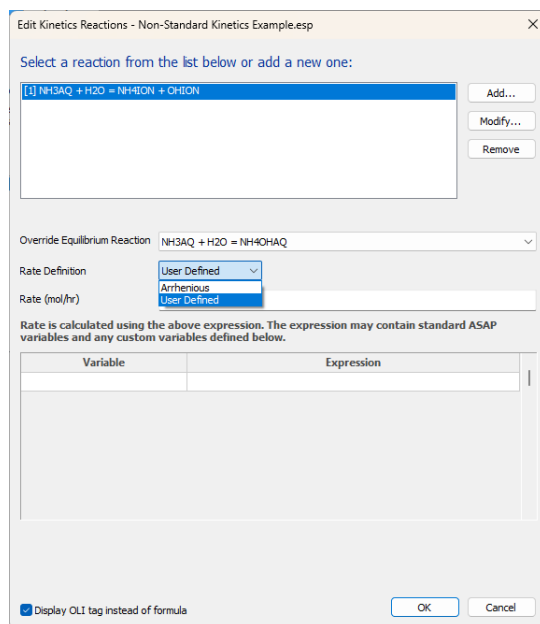

We first must enter our variables and expressions in the lower half of the dialog. Each variable must be on a separate row.

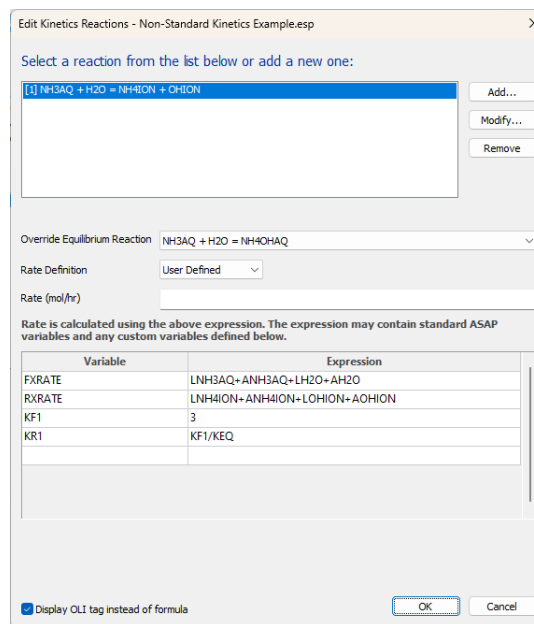

You now must enter the overall rate expression in the box marked **Rate**.

Click ok to accept this information.

Edit Kinetics Reactions - Non-Standard Kinetics Example.esp

Select a reaction from the list below or add a new one:

[1] $\text{NH}_3\text{AQ} + \text{H}_2\text{O} = \text{NH}_4\text{ION} + \text{OHION}$

Add...
Modify...
Remove

Override Equilibrium Reaction: $\text{NH}_3\text{AQ} + \text{H}_2\text{O} = \text{NH}_4\text{OHAQ}$

Rate Definition: User Defined

Rate (mol/hr): $(\text{KF1} * \text{EXP}(\text{FXRATE}) - \text{KR1} * \text{EXP}(\text{RXRATE})) * \text{VOLLIQ} / 1000$

Rate is calculated using the above expression. The expression may contain standard ASAP variables and any custom variables defined below.

Variable	Expression
FXRATE	$\text{LN}(\text{NH}_3\text{AQ} + \text{ANH}_3\text{AQ} + \text{LH}_2\text{O} + \text{AH}_2\text{O})$
RXRATE	$\text{LN}(\text{NH}_4\text{ION} + \text{ANH}_4\text{ION} + \text{LOHION} + \text{AOHION})$
KF1	3
KR1	$\text{KF1} / \text{KEQ}$

Display OLI tag instead of formula

OK Cancel

Enable the kinetics reaction by checking the box.
Return now to the flowsheet.

Flowsheet Chemistry x Report-1

Inflows Databanks Phases Redox Kinetics T/P Span

Select kinetics reactions included in this model

Use the 'Edit' button to create/modify reactions.

Kinetic reactions are shared across all chemistry models defined in the process. You can create as many reactions as you want, only those that are enabled here are included in this model.

Hint: You can define multiple reactions that have the same equation. This allows different chemistry models to have reactions that have the same equation but have different rate specifications.

Edit

[1] $\text{NH}_3(\text{aq}) + \text{H}_2\text{O}(\text{aq}) = \text{NH}_4^+ + \text{OH}^-$

Create a flowsheet with a reactor block with a single feed stream and a single product stream such as the following:

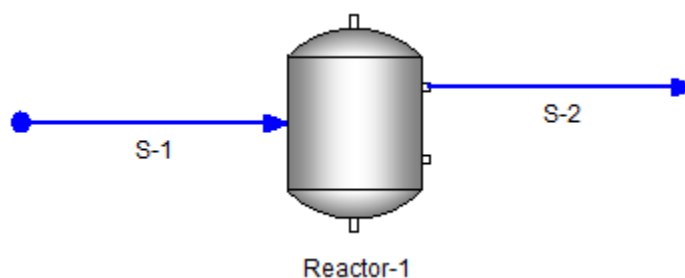

Enter the following for the feed stream parameters:

Feed Stream Parameters	
Feed Stream Name	S-1
Temperature	25 °C
Pressure	1 atm
Total Flow	Automatic
H2O	55.5087 mol/hr
NH3	0.1 mol/hr

Enter the following for the Reactor block parameters:

Reactor Block Parameters	
Reactor Type	Kinetics
Kinetic Parameters (<i>flyout dialog</i>)	
Number of Stages	10
Residence Time (hr)	100
Calculation Type	Isothermal
Pressure Spec.	Min. Inlet Pressure
Temperature (°C)	25.0
Chemistry Model	Default

Run the process.

Here we have displayed the output of the process using callouts:

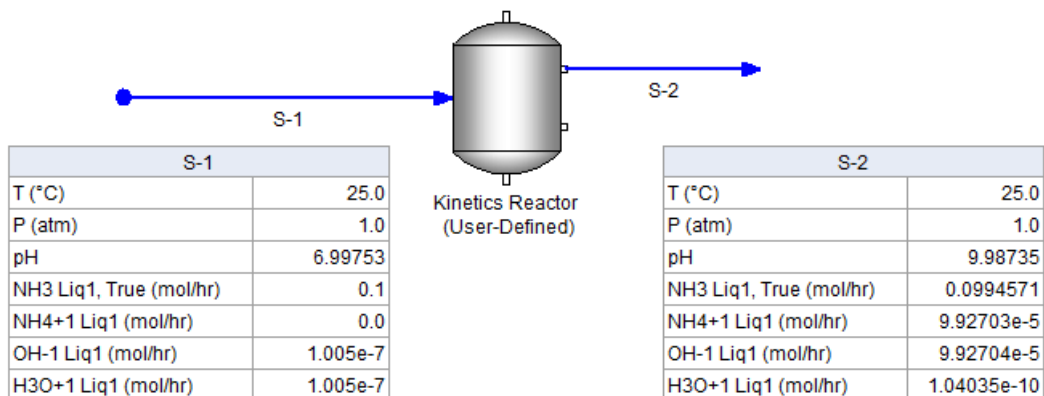

The stream S-1 represents the equilibrium condition. The stream pH is approximately 7.0. The stream S-2 represents the condition with reaction kinetics limiting the reforming of ammonia from the ammonium ion. The pH is much higher, at approximately 9.99, which shows that it is not at equilibrium.

Stoichiometric Reactors (CONV)

Stoichiometric reactors in the ESP Original program were called CONV (conversion) reactors. These reactors used a simple stoichiometric relationship between reactants and products. There is no time factor for these reactions.

In this example, we will mimic the bio-remediation of phenol (C_6H_5OH) using aerobic degradation. The reaction we are simulating is:

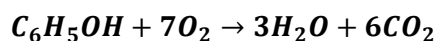

Start OLI Flowsheet: ESP and create the following chemistry:

Stoichiometric Reactor		
Thermodynamic Framework	MSE (H3O+ Ion)	
Additional Databanks	None	
Phases	Default	
Redox	Off	
Inflows	Formula	OLI Tag Name
Water	H ₂ O	H2O
Phenol	C ₆ H ₅ OH	C ₆ H ₅ OH
Oxygen	O ₂	O ₂
Carbon Dioxide	CO ₂	CO ₂

Unlike previous reactors, we do not define the stoichiometric parameters in the chemistry section. Create a flowsheet with the following block and streams:

Create a flowsheet with a reactor block with a single feed stream and four product streams such as the following:

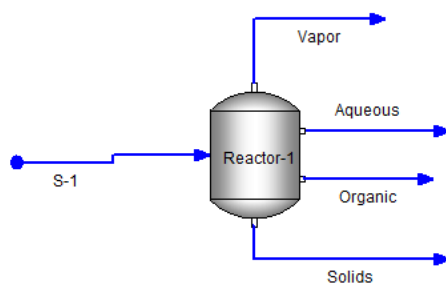

Enter the following feed stream parameters:

Feed Stream Parameters	
Feed Stream Name	S-1
Temperature	25 °C
Pressure	200.0 atmosphere
Total Flow	Automatic
H2O	55.0 mol/hr
C6H5OH	1.0 mol/hr
O2	7.0 mol/hr

Now enter the block parameters:

Reactor Block Parameters	
Reactor Type	Stoichiometric Conversion
Reactions	
Conversion (edit)	Reaction C6H5OH + 7O2 = 3H2O + 6CO2
Key Component	C6H5OH
Conversion factor	0.4
Calculation Type	Isothermal
Pressure Spec.	Min. Inlet Pressure

Temperature (°C)	25.0
Chemistry Model	Default

Here are the individual steps for this type of reactor. Click on the reactor you have added. This will display the properties dialog for the block:

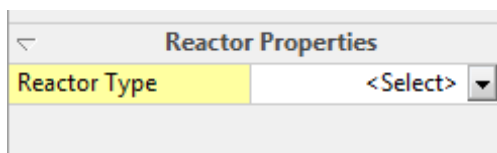

Change the type of reactor to **Stoichiometric Conversion**.

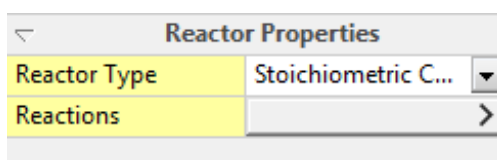

Click on the **Reactions** button. This will display a fly-out dialog.

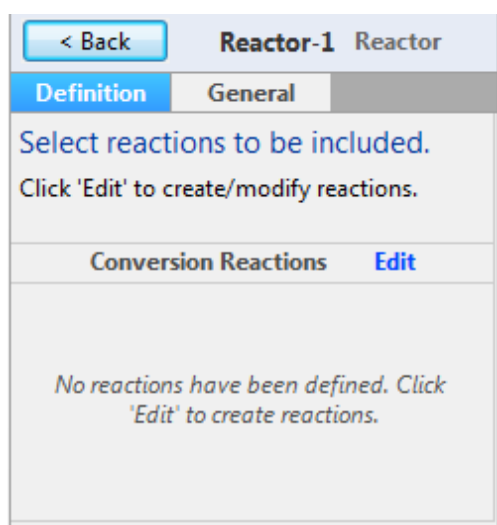

This brings up a familiar dialog. Normally we used this dialog in the chemistry section, but now we are using the same dialog in the block.

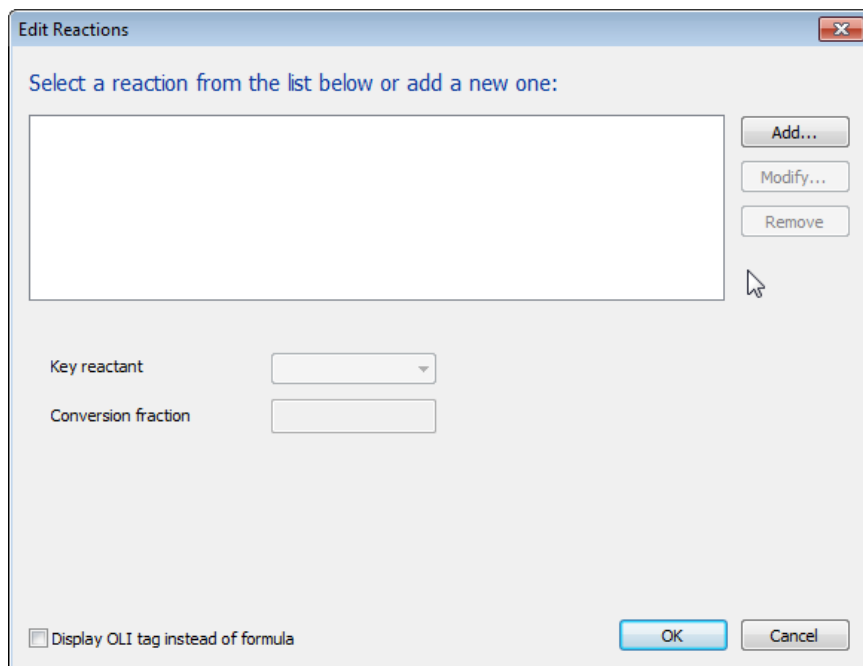

Click the **Add** button.

As we did in the previous section, we will now add the equation from above.

Click **OK**

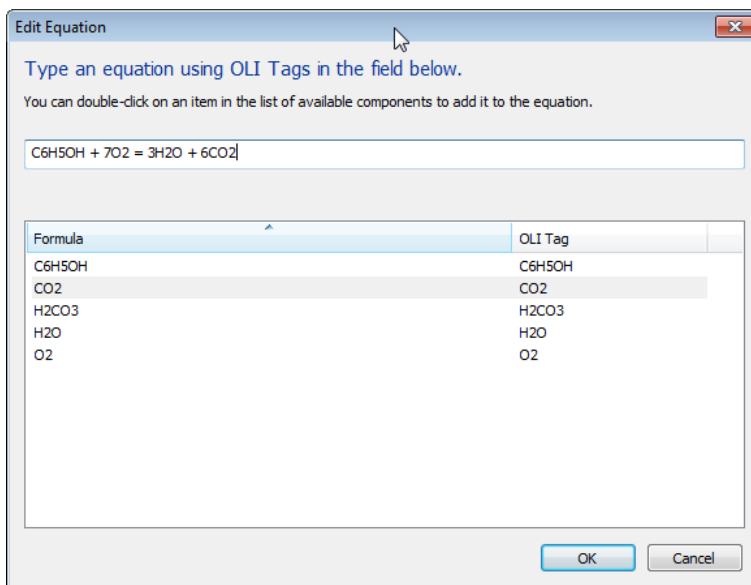

We now must define the key reactant. This is what the conversion is based on. Select phenol (C₆H₅OH).

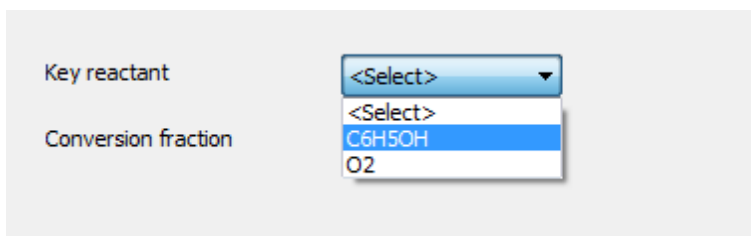

For our purposes, we are converting 40% (on a mole basis), so enter 0.4.

Key reactant	C6H5OH
Conversion fraction	0.4

Click **OK** to continue.

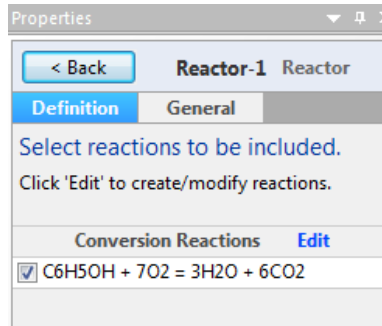

We have run our sample process at very high pressure to force the oxygen into solution. Here are the results:

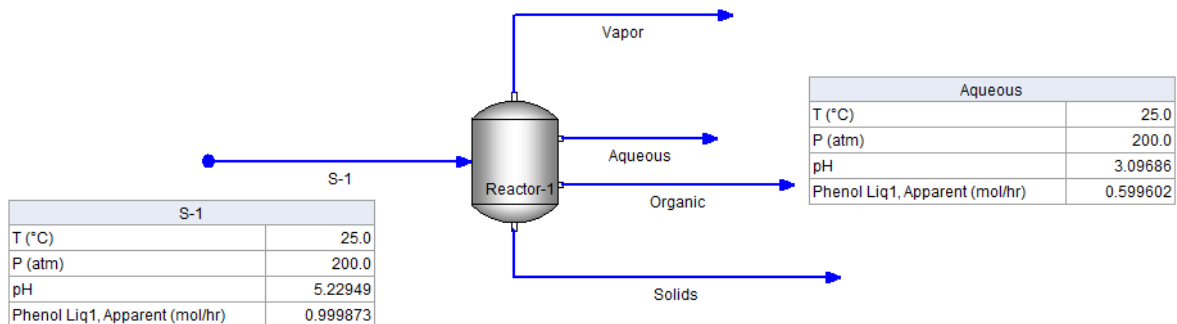

We started with 1.0 mole of phenol (0.999873 is ~1.0 mole) and have 0.599602 mole. This means we have reacted 40% of the phenol, which is what the conversion factor was set to.

Gibbs Reactor

A Gibbs reactor is a special type of reactor in OLI Flowsheet: ESP in that it does not evaluate the standard equilibrium equations found in the Chemistry Model. Rather, it minimizes the Gibbs Free Energy at a given temperature and pressure or maximizes entropy at a given pressure and enthalpy. The latter is usually what is calculated in OLI Flowsheet: ESP.

Create a flowsheet with the following configuration:

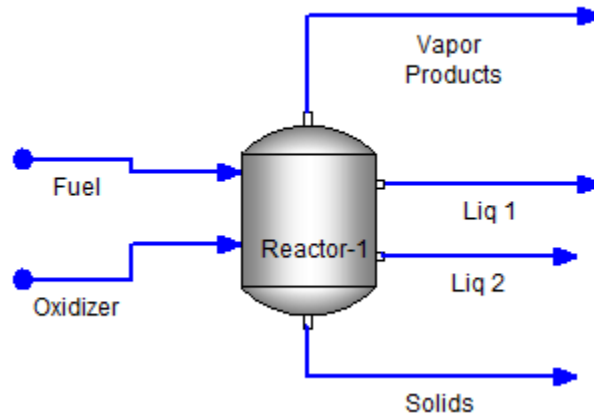

Create the chemistry model with the following parameters:

Gibbs Reactor		
Thermodynamic Framework	MSE (H3O+ Ion)	
Additional Databanks	None	
Phases	Default	
Redox	Off	
Inflows	Formula	OLI Tag Name
Water	H ₂ O	H2O
Methane	CH ₄	CH4
Oxygen	O ₂	O2
Carbon Dioxide	CO ₂	CO2
Nitrogen	N ₂	N2
Carbon Monoxide	CO	CO

Enter the parameters for each inlet stream:

Feed Stream Parameters		
Feed Stream Name	Fuel	
Temperature	25	°C
Pressure	1.0	Atm
Total Flow	1 m3/hr	m3/hr
H2O	0.0 mol/hr	mol/hr
CH4	100.0	mol/hr
O2	0	mol/hr
CO2	0	mol/hr
N2	0	mol/hr
CO	0	mol/hr

Feed Stream Parameters		
Feed Stream Name	Oxidizer	
Temperature	25	°C
Pressure	1.0	Atm
Total Flow	0.1 m3/hr	m3/hr
H2O	0.0 mol/hr	mol/hr
CH4	0.0	mol/hr
O2	20	mol/hr
CO2	0	mol/hr
N2	80	mol/hr
CO	0	mol/hr

Enter the block parameters for the reactors. We will describe the details about the new parameters after the table.

Reactor Block Parameters	
Reactor Type	Gibbs
Reacting Vapor Species	
CH4	Enabled
CO	Enabled
CO2	Enabled
H2O	Enabled
N2	Disabled
O2	Enabled
Calculation Type	Adiabatic
Pressure Spec.	Min. Inlet Pressure
Heat Duty	0.0
Chemistry Model	Default

This type of reactor requires the user to specify which vapor species can react. In this case, we are simulating a combustion reaction, so we do not require Nitrogen gas to be reactive. After specifying the reactor type, we need to enable the gases.

Click the fly-out button next to **Reacting Vapor Species**.

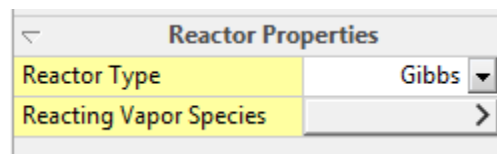

Check the following components:

CH4
CO
CO2
H2O
O2

Click the **Back** button and then run the calculation.

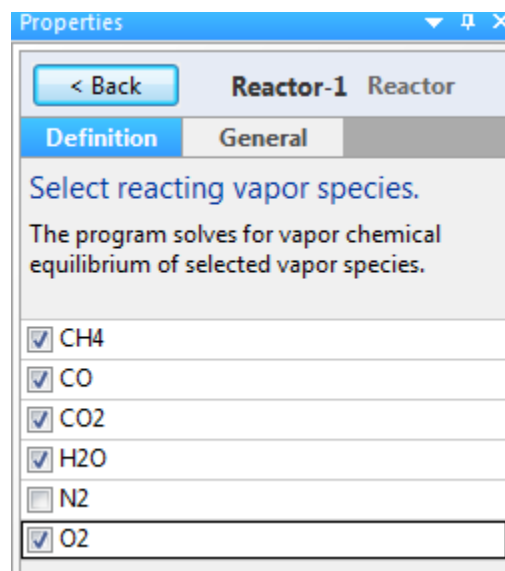

The simulation results are presented in the callout tables.

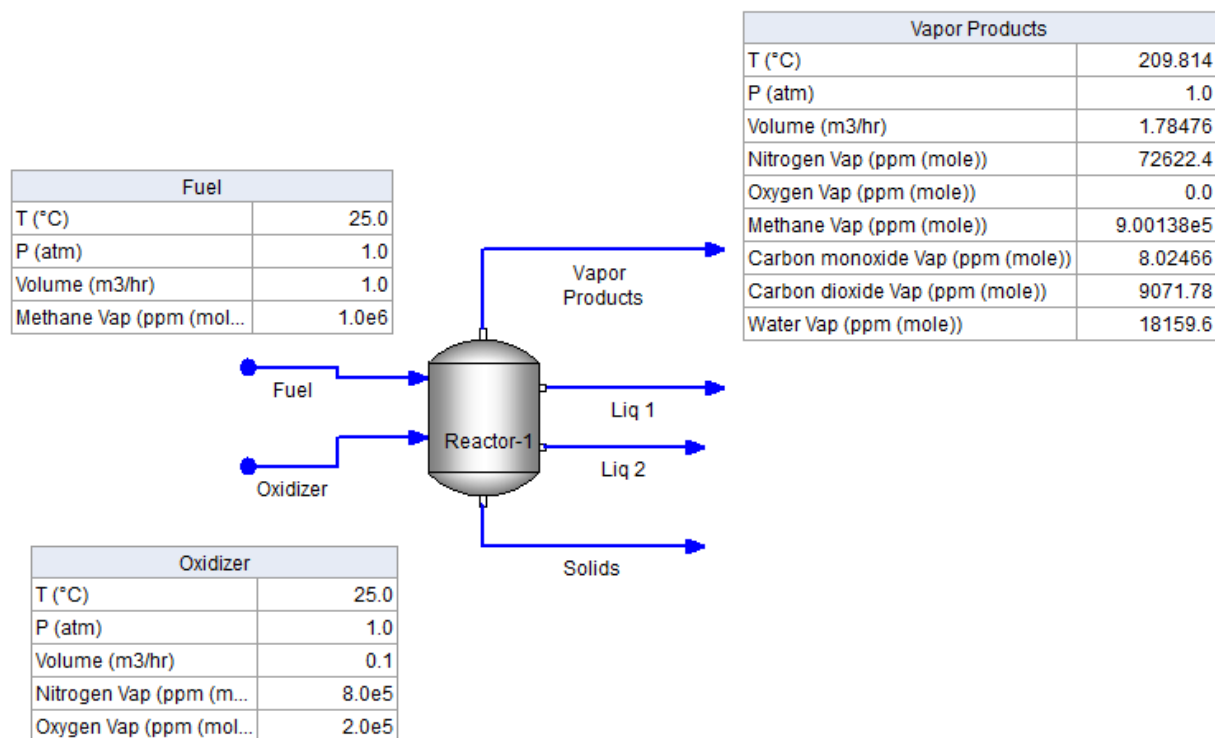

You can see that we have reacted methane with oxygen and have formed the traditional combustion products of carbon dioxide and water. We also have some incomplete combustion and have formed some carbon monoxide at approximately 8 ppm. There has also been a temperature increase.

RO Membranes (Reverse Osmosis) Example

Overview of RO

This example of an RO membrane compares the OLI Flowsheet: ESP simulation with a real-world application. In this case, we are simulating a desalination plant located in the Middle East, built to the World Health Organization's standards. The overall process flowsheet is shown in the image below:

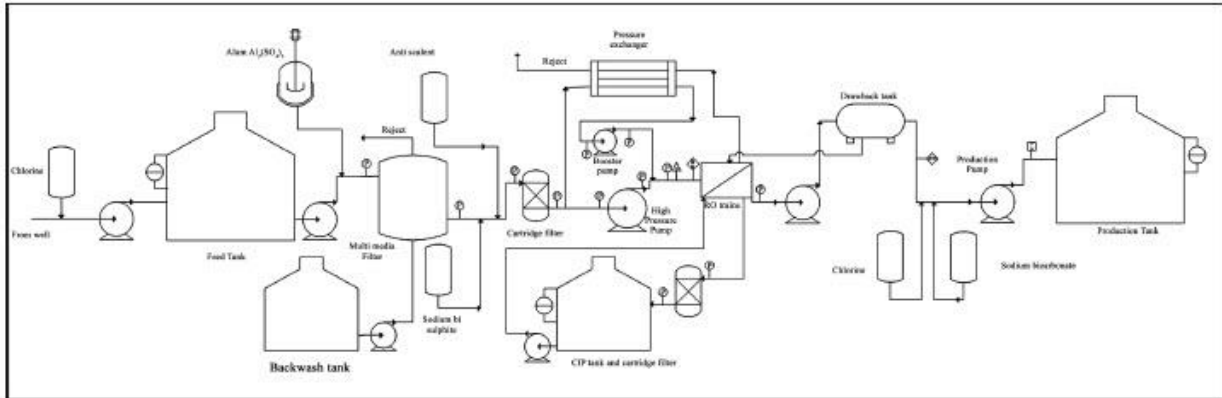

Flowsheet RO plant⁸

The goal of this simulation is to confirm that the objective of having a permeate flow rate of a minimum of 3600 m³/day with a TDS (total dissolved solids) less than 100 ppm. The brackish feedwater is over 10,000 TDS.

In this simulation, we will concentrate on only the pH pretreatment section and the RO membrane itself.

Defining the Chemistry Model

For this simulation, we are assuming you already know how to use OLI Flowsheet: ESP. We need to first define the chemistry for this process. Start OLI Flowsheet: ESP and click on the Chemistry Tab.

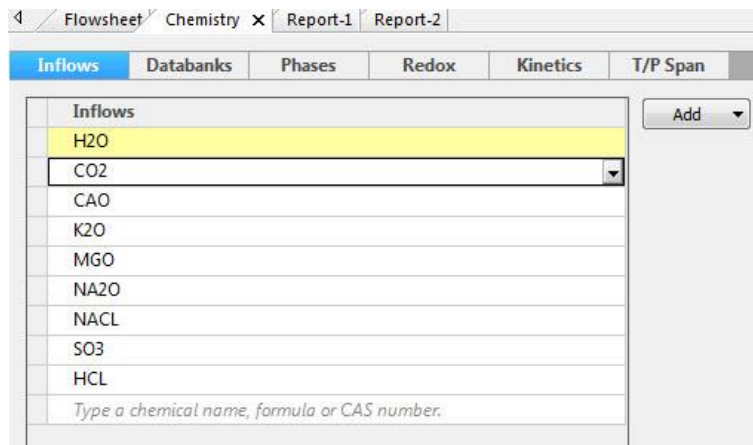

Click on the databanks tab to select MSE

⁸ Source: Abdel-Fatah, M.A., El-Gendi, A and Ashour, F. (2016) Performance Evaluation and Design of RO Desalination Plant: Case Study. *Journal of Geoscience and Environment Protection*, 4, 53-63

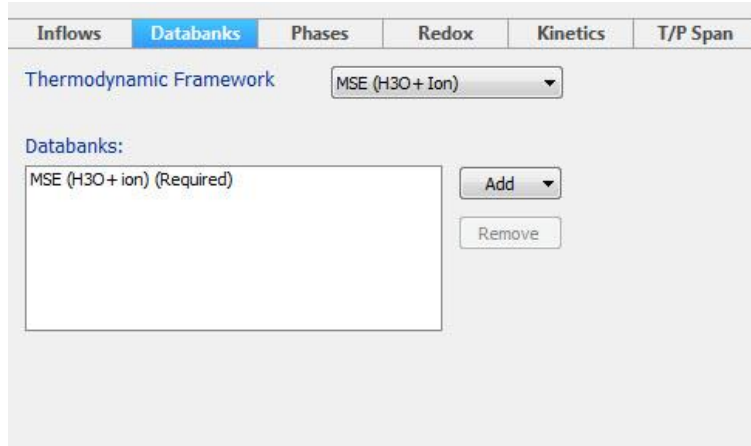

Defining the Flowsheet

The following diagram shows the partially completed flowsheet. Please enter the blocks from the palette and arrange as shown.

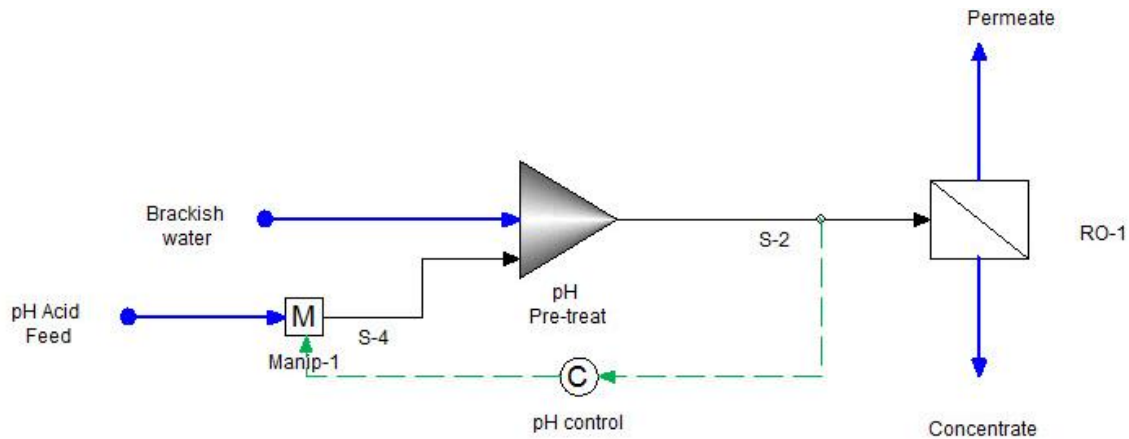

Entering the stream and block parameters (except the RO membrane).

We have shown you how to do this before, so we will just summarize the parameters in table form:

Feed Stream Parameters		
Feed Stream Name	pH Acid Feed	
Temperature	25	°C
Pressure	1.0	Atm
Total Flow	1.0	m3/day
H2O	99.0	mass %
CO2	0	mass %

CAO	0	mass %
K2O	0	mass %
MGO	0	mass %
NA2O	0	mass %
NACL	0	mass %
SO3	0	mass %
HCL	1.0	mass %

Feed Stream Parameters		
Feed Stream Name	Brackish water	
Temperature	25	°C
Pressure	1.0	Atm
Total Flow	7200	m3/day
H2O	1326.38	mol/day
CO2	0.176125	mol/day
CAO	0.220969	mol/day
K2O	0.139955	mol/day
MGO	0.16293	mol/day
NA2O	0.0196066	mol/day
NACL	1.6363	mol/day
SO3	0.502502	mol/day
HCL	0.0	mass %

The TDS has been calculated for this stream to be approximately 7400 mg/L

Block Parameters	
Block Type	Manipulator
Block Name	Manip-1
Streams	
Inlet	pH Acid Feed
Outlet	S-4
Parameters	
Manipulator Type	Total Flow
Factor, Flow	1.0
Chemistry Model	Default

Block Parameters	
Block Type	Mixer
Block Name	pH Pre-Treat
Streams	
Inlet	Brackish Water
Outlet	S-2
Parameters	
Calculation Type	Adiabatic
Pressure Spec.	Absolute Pressure
Pressure (Bar)	21.6
Heat Duty (cal/hr)	0
Chemistry Model	Default

Block Parameters

Block Type	Feedback Controller	
Block Name	pH Control	
Parameters		
	Target Stream	S-2
	Spec Type	pH
	Target Value	6.0
	Heat Duty (cal/hr)	0
Control Parameters		
	Controlling Block	Manip-1
	Block Parameter	Factor, Flow
Options		
	Calculate After	<automatic)
	Disable this Controller	No (unchecked)

Defining the RO Membrane Block

The RO Membrane block is a relatively complicated block. For this simulation, we are using the parameters of a real membrane. The membrane under consideration is DOW FilmTec™ BW30-400 Element⁹.

RO-1 RO Membrane	
Definition	General
Inlets and Outlets >	
Membrane Element Performance Data >	
Operational Parameters	
Permeate Pressure (bar)	3.0
Specify one of the following. If overall permeate recovery is specified, the total no. of vessels is calculated automatically. Feed flow is divided equally among the total no. of vessels.	
<input checked="" type="radio"/> Total No. of Vessels	26
<input type="radio"/> Overall Permeate Recovery (vol %)	50.0
No. of Elements per Vessel	5
Fouling Factor	0.8
Pressure Drop per Element (bar)	0.5
pH Control (Optional) >	
Advanced Options	
Control Electroneutrality by	Adjusting Cations ▾
Chemistry Model	Chemistry (Default) ▾

There is a lot of data to enter for this simulation. The first is to confirm the **Inlets and Outlets**.

Properties	
< Back RO-1 RO Membrane	
Definition	General
Inlets	
Feed	S-2 ▾
Outlets	
Permeate	Permeate
Concentrate	Concentrate

Click the **Back** button.

Now, we need to define our RO membrane parameters. Click the **Membrane Element Performance Data** button.

⁹ DOW FilmTec is a registered trademark of the DOW Chemical Company. The parameters were taken from the paper referenced earlier in this section.

Properties ▾ □ ✕

[< Back](#) **RO-1 RO Membrane**

Definition **General**

Membrane Element Performance Data
Specify performance data under test conditions.

Performance Data Type	Manufacturer Data Sheet ▾
Select Membrane	Select...
Manufacturer / Model	DOW / BW30-400
Active Area (sq-m)	37.0
Permeate Flow (m ³ /day)	40.0
Permeate Recovery (vol %)	15.0
Temperature (°C)	25.0
Applied Pressure (bar)	15.5

Salt Concentrations and Rejections

Component	Concentration mg/L	Rejection %
NaCl ▾	2000.0	99.5
<Select> ▾		

Manufacturer data retrieved on 3/10/2018 - Source URL.

Membrane Model Library

Add Specified Data to Library Add...

[Change library settings](#)

Properties Watch

The most common source of data will be from a manufacturer's data sheet. From the data sheet, we have the following values.

RO Element Data	
Active Area (m²)	37.0
Permeate Flow (m³/day)	40
Permeate Recovery (vol %)	15
Temperature (°C)	25
Applied Pressure (bar)	15.5

These values were developed by the manufacturer at a test condition. In this case, the manufacturer has provided the test data.

Salt Concentrations and Rejections		
Component	Concentration mg/L	Rejection %
NaCl	2000.0	99.5
<Select>		

It is important to note that these conditions are required to simulate the RO Membrane. However, your actual feed solution may contain different amounts of NaCl as well as other minerals. OLI has developed correlations for how these membranes will respond to various ions at varying concentrations.

You can also save this membrane for use in later simulations by clicking the **Add...** button.

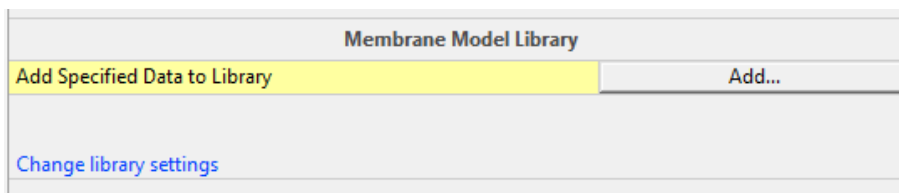

Clicking the **Add** button will display a new dialog:

The **Manufacturer/Category** allows you to select the company that provided the data.

Here we have added the name “DOW” and the model number:

Add Membrane Element Data to Library [X]

Manufacturer/Category: DOW

Model Name: BW30-400

Reference:

DOW Chemical.

[Add] [Cancel]

Click the **Add** button.

You will notice that the Data grid has updated.

Click the **Back** button.

Now we need to specify the **Operational Parameters**.

Operational Parameters	
Permeate Pressure (bar)	3.0
Specify one of the following. If overall permeate recovery is specified, the total no. of vessels is calculated automatically. Feed flow is divided equally among the total no. of vessels.	
<input checked="" type="radio"/> Total No. of Vessels	26
<input type="radio"/> Overall Permeate Recovery (vol %)	50.0
No. of Elements per Vessel	5
Fouling Factor	0.8
Pressure Drop per Element (bar)	0.5
pH Control (Optional) >	
Advanced Options	
Control Electroneutrality by	Adjusting Cations
Chemistry Model	Chemistry (Default)

The Permeate Pressure is the pressure on the downstream side of the membrane and is usually determined by other operational considerations. The total number of vessels are the actual RO units under consideration. The number of vessels was set by the authors of the reference mentioned previously (Abdel-Fatah, et al.).

The number of Elements per Vessel was set to 5. The authors used 6, but that number falls outside the permitted range by OLI. The authors set a fouling factor of 0.8 and a pressure drop per element of 0.5 bar.

As the ions move across the membrane, there is a mathematical imbalance in electrical charge. The user can specify if the imbalance is corrected by adding/removing cations or anions. Cations are the default value.

At this point, the membrane is fully defined, and we are ready to run the simulation.

Running the simulation

The simulation was run without any additional tweaks. We have added some callouts to make analyzing the simulation easier.

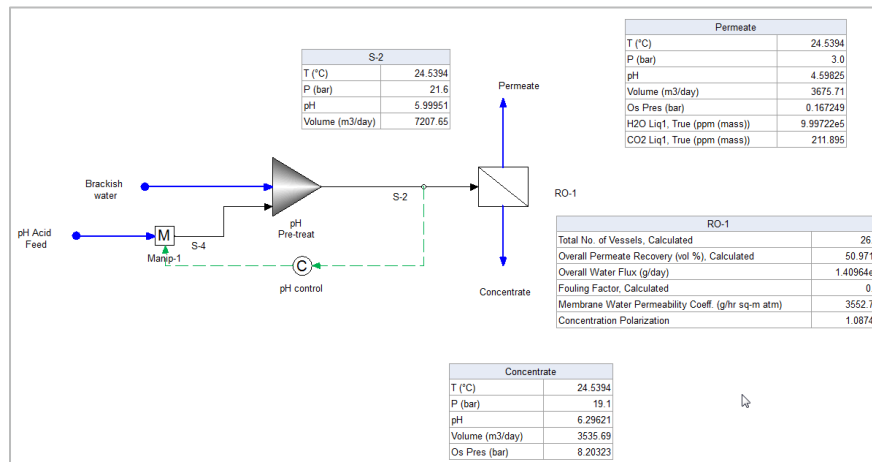

The brackish water has a TDS of approximately 7400 mg/L. Remember, the World Health Organization wants a TDS of less than 100 mg/L. Reviewing the Permeate stream, we can see some values that are useful to us.

To report the TDS value, we need to turn on this calculation. **Select the Permeate Stream, go to the Definition tab, and enable the Total Dissolved Solids Calculation (TDS) Estimated.**

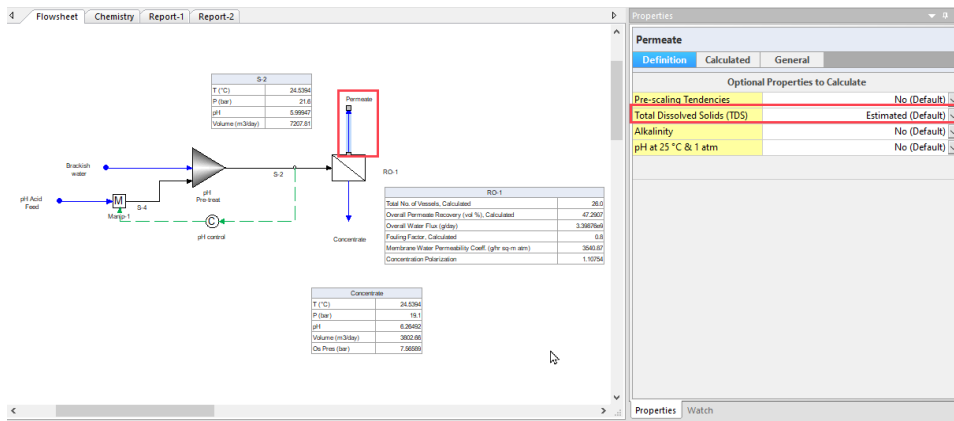

Run the simulation.

Double-click on the **Permeate Callout**. This will open a new window. Go to the **Stream Parameters** section, click on the '+' icon, and select **Total Dissolved Solids**. Double-click it or use the → arrow to put this variable under the *Selected Variables* window. Then click **OK**.

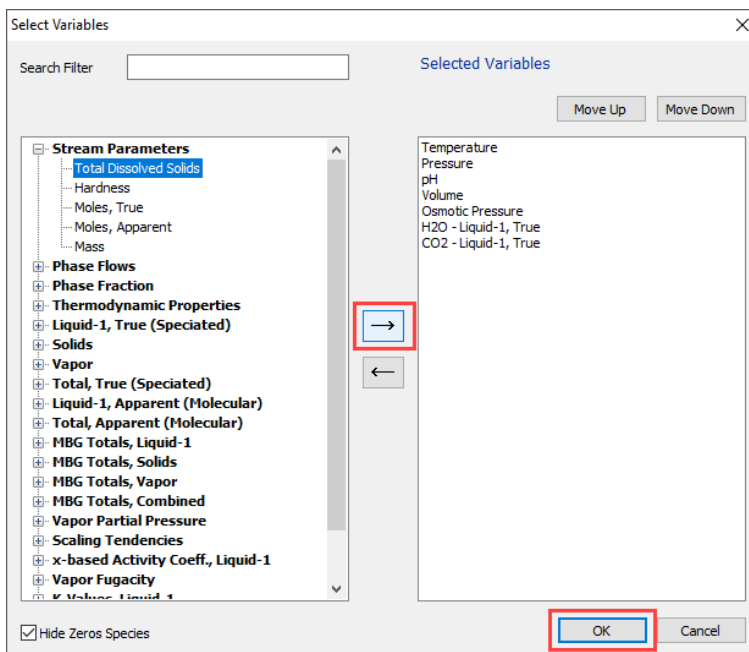

The calculated TDS value is ~ 70.8 mg/L.

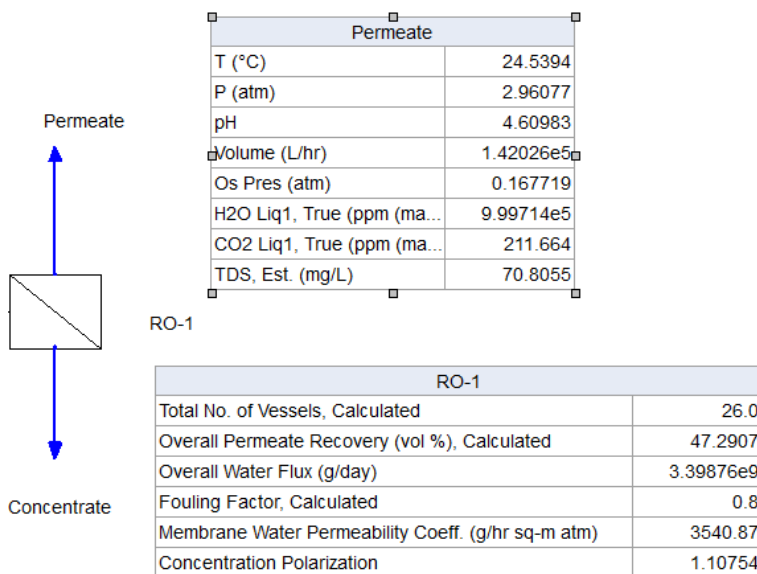

This certainly achieves the World Health Organization specification of less than 100 mg/L. The authors also wanted to have a permeate flow rate of more than 3600 m³/day, and we are reporting slightly more at 3675 m³/day.

This shows that the OLI RO Membrane matches a peer-reviewed academic project.

You can download a worked copy of this example by contacting [OLI Support](#) and requesting the RO Membrane example (Chapter VIII – RO Example.esp).

Calculator Functionality Example

Calculator Block

Calculator functionality examples and video tutorials can be found on our [Support Center](#) and [OLI YouTube channel](#):

Support Center article: <https://support.olisystems.com/hc/en-us/articles/32438667788051-The-Calculator-Functionality>

Calculator Block Introduction – Part 1: <https://youtu.be/pvKifxvU2co>

This video introduces the User-Defined Property (also known as Global Variable). Users can employ mathematical subexpressions and existing OLI properties to create unique parameters that are calculated for all streams in the file. Its value can be displayed in the Callout Box and the Report for each stream. It is also accessible in controllers and in defining the objective function of Optimizer runs.

Calculator Block Intro Part 2 – Local Calcs: <https://youtu.be/ojsrsN5-mvo>

This video introduces the Calculator Block, which is a new unit object in version 12 that creates local custom variables. The output values can be displayed in a Callout Box for the Block and propagated elsewhere in the Flowsheet as targets in controllers. Additionally, each Calculator Block output can be studied as a dependent variable in a Sensitivity Analysis.

Appendix-1 Reverse Osmosis Technology

OLI MEMBRANE TECHNOLOGY: SIMULATOR FOR REVERSE OSMOSIS PROCESS

Summary

To model the transport mechanism inside the membrane, solution-diffusion approach has been incorporated. In the solution-diffusion model, it is proposed that transfer of ions and water through polymeric membranes occurs via a solution diffusion mechanism because of dissolution of permeates in the membrane materials [1]. The water flux through the membrane is a function of water permeability coefficient, hydrodynamic pressure difference and osmotic pressure difference across the membrane, whereas, the solute flux through the membrane is a function of solute permeability constant and solute concentration gradient across the membrane [2]. Molecular size of the ions strongly affects the transport characteristics of the ions due to the sieving action of the membranes. However, in a water environment, different number of water molecules surround each cation and anion. Thus, the real radius of an ion is the one that considers the water molecules around it (i.e., the hydrated ion radius) rather than the absolute ionic crystal radius. Regardless of membrane type, the type of experiment, and the membrane configuration, the salt permeabilities are inversely proportional to the hydrated radii of the ions [3]. In the OLI membrane model, permeability of ions has been correlated with their hydration numbers.

In general, the typical order of rejection of cations by reverse osmosis membranes follows $Fe^{3+} > Ni^{2+} \approx Cu^{2+} > Mg^{2+} > Ca^{2+} > Na^+ > K^+$, and $PO_4^{3-} > SO_4^{2-} > HCO_3^- > Br^- > Cl^- > NO_3^- \approx F^-$ for anions [4]. The permeability of cations and anions, calculated as a function of hydration numbers, follows the typical trends. For some organics with the same homologous group (i.e., alcohols, phenols, acids), the rejections have been correlated by calculating the topological parameters characterizing molecular structure [5]. For other neutrals, self-diffusivities relative to water have been used to correlate the permeability.

Commercial membrane manufacturers provide a product specification sheet for each type of membrane. In addition to physical dimensions (i.e., membrane area), the product sheet also reports performance of the membrane (i.e., permeate flux, recovery, and rejection percentage for NaCl or other solutes) at specific test conditions. User-entered test conditions data are the key information for calculating the permeability coefficients of water and the test solute for the membrane element. These calculated permeability coefficients, along with the above-mentioned correlations, are used to estimate the permeability coefficients of other species present. The advantage of this method is that a reasonable and preferential order of permeabilities for the membrane, regardless of membrane type, can be correctly estimated.

In the current OLI membrane development, users can enter the number of membrane elements per vessel and the total number of vessels in the assembly. Alternatively, users can estimate the total number of vessels required (or total membrane area) for a specific recovery. Concentration polarization is approximated using Peclet number and intrinsic enrichments [4]. Flow factor (sometimes referred to as fouling factor) is estimated from the water activity reduction unless specified by the users. Users may specify feed-side pressure drop per element if available. There are options for conditioning the feed to a specific pH by choosing a pH acid titrant or base titrant.

Model Development

Water flux in the RO membrane is a function of membrane permeability of water, applied pressure, and the feed water osmotic pressure. According to solution-diffusion model, water flux can be calculated from the following equations:

$$J_w = AP_w(\Delta P - \Delta\pi); \text{ For water} \quad (1)$$

$$J_{si} = AP_{si}(C_{si} - C_{pi}); \text{ For } i = 2, n \text{ (water is not included)} \quad (2)$$

where J_w , P_w , ΔP , $\Delta\pi$ and A represent water flux through the membrane, water permeability, membrane pressure gradient, osmotic pressure gradient, and membrane area, respectively. J_{si} , P_{si} , C_{si} and C_{pi} represent species i flux through the membrane, permeability, concentration at the membrane surface, and concentration at the permeate side, respectively. It is to be noted that n represents the total number of aqueous and ionic species in the system.

$$\Delta P = P_f - P_{pd} - P_p \quad (3)$$

where P_f , P_{pd} and P_p represent feed side pressure, pressure drop at the concentrate (residue) side, and permeate pressure, respectively.

$$P_{pd} = 0.005Q_{avg}^{1.7} \quad (4)$$

$$Q_{avg} = \frac{Q_f + Q_c}{2} \quad (5)$$

where Q_f , Q_c and Q_{avg} represent feed, concentrate, and average concentrate (residue) side flow rate, respectively.

$$\Delta\pi = \pi_{avg} - \pi_p \quad (6)$$

$$\pi_{avg} = \frac{\pi_f + \pi_c}{2} \quad (7)$$

where π_f , π_p , π_c , and π_{avg} represent feed side osmotic pressure, permeate side osmotic pressure, concentrate (residue) side osmotic pressure, and average concentrate (residue) side osmotic pressure, respectively.

The salt concentration adjacent to the membrane surface is higher than the bulk solution concentration because reverse osmosis membranes preferentially permeate water and retain salt. Water and salt are brought toward the membrane surface by the flow of solution through the membrane. Water and a little salt permeate the membrane, but most of the salt is rejected by the membrane and retained at the membrane surface. Salt accumulates at the membrane surface until a sufficient gradient has formed to allow the salt to diffuse to the bulk solution [4]. The increase or decrease of the concentration at the membrane surface relative to the bulk solution concentration determines the extent of concentration polarization.

$$CP = \frac{e^{PK}}{1 + E_0(e^{PK} - 1)} \quad (8)$$

$$PK = J_v \delta / D_v \quad (9)$$

where CP , PK , E_0 , J_v , δ , and D_v represent concentration polarization modulus, Peclet number, enrichment factor, typical flux through membrane, boundary layer thickness, and typical diffusion coefficient, respectively.

$$C_{si} = C_{pi} + CP(C_{fi} - C_{pi}) \quad (10)$$

where C_{si} and C_{fi} represent concentration at the membrane surface and feed side bulk concentration for the species, respectively.

The fouling factor is applied to the membrane due to loss of permeability by compaction and scale fouling. Typically, a fouling factor less than 1.0 is applied depending on the membrane life. A correlation was developed for fouling factor which considers the water activity reduction at the membrane surface due to permeation relative to the fresh membrane under the test conditions.

$$FF = function(T_c, \pi_{avg}) \quad (11)$$

where FF , T_c , and π_{avg} represent fouling factor, concentrate (residue) side temperature, and average concentrate (residue) side osmotic pressure, respectively.

The osmotic pressure, self-diffusivity, and densities are calculated in OLI's Mixed-Solvent Electrolyte (MSE) or Aqueous (AQ) framework.

Equations (1-11) constitute the solution of the RO membrane and are simultaneously solved to calculate J_w , J_{si} , C_{pi} , C_{si} , CP and FF .

Permeability Estimate

In a water-rich environment, hydration numbers refer to the number of water molecules in the vicinity of the ion. Thus, the real radius of an ion is the one that considers the water molecules around it (i.e., the hydrated ion radius) rather than the absolute ionic crystal radius. The water molecules that these hydration numbers pertain to presumably move together with the ions and are sufficiently firmly attached to them by ion-dipole interactions and hydrogen bonding to constitute a fairly stable entity [6]. Stokes radii are calculated as a function of ionic limiting conductivities and charge of species. The Stokes radii are corrected to relate Van Der Waals ionic sizes [7, 8]. The hydration numbers are calculated as a function of corrected Stokes radii, ionic limiting standard molar volume, and molar volume of water. Membrane-specific permeation behavior found in open literature was analyzed, and from the analyzed data, a correlation was developed for permeability as a function of hydration numbers. It is worth mentioning that regardless of membrane type, the type of experiment, and the membrane configuration, the salt permeabilities are inversely proportional to the hydrated radii of the ions [3]. However, for regressing the water permeability and key components (test solutes) permeabilities, a modified subset of equations (1-11) was formulated and simultaneously solved based on the performance data provided. After calculating water and key component permeabilities, an update (but preserving the trend) in the aforementioned correlation was achieved, and the permeabilities of the rest of the ionic species were calculated from the updated correlation. The advantage of this technique is that a reasonable and preferential order of permeabilities for the membrane, regardless of membrane type, can be correctly estimated.

For some organics with the same homologous group (i.e., alcohols, phenols, acids), the rejections were correlated by calculating the topological parameters characterizing molecular structure [5]. For other neutrals, self-diffusivities relative to water were used to correlate the permeability. These calculated permeabilities remain constant unless there is a change in temperature.

References

- [1] S.M.J. Zaidi, F. Fadhillah, Z. Khan, and A.F. Ismail. Salt and water transport in reverse osmosis thin film composite seawater desalination membranes. *Desalination*, 368 (2015) 202.
- [2] P. Mukherjee, A. Sengupta. Ion exchange selectivity as a surrogate indicator of relative permeability of ions in reverse osmosis processes. *Environ. Sci. Technol.*, 37 (2003) 1432.
- [3] S.M.S. Ghiu, Mass transfer of ionic species in direct and reverse osmosis processes, Doctoral dissertation, University of South Florida, 2003.
- [4] R.W. Baker, *Membrane technology and applications*, 2nd Ed., Chichester, England: Wiley, 2004.
- [5] A. Książczak, A. Anderko. A chemical approach to the prediction of thermophysical properties of associating compounds. *Berichte der Bunsengesellschaft für physikalische Chemie*, 92 (1988) 496.
- [6] Y. Marcus. *Ion properties*, 1st Ed., New York: Marcel Dekker, 1997.
- [7] Y. Marcus. *Ion solvation*, 1st Ed., New York: John Wiley & Sons, 1985.
- [8] R.E. Nightingale. Phenomenological theory of ion solvation: Effective radii of hydrated ions, *J. Phys. Chem.*, 63 (1959) 1381.

Definitions

Number of Elements/Vessel and Total Number of Vessels

An Element is the building block (e.g., a single membrane unit operation block) of the membrane assembly. Many elements are connected together to form a vessel.

Below is a diagram of 5 Elements/Vessel and a total of 2 Vessels membrane assembly. The feed will be equally divided among the vessels.

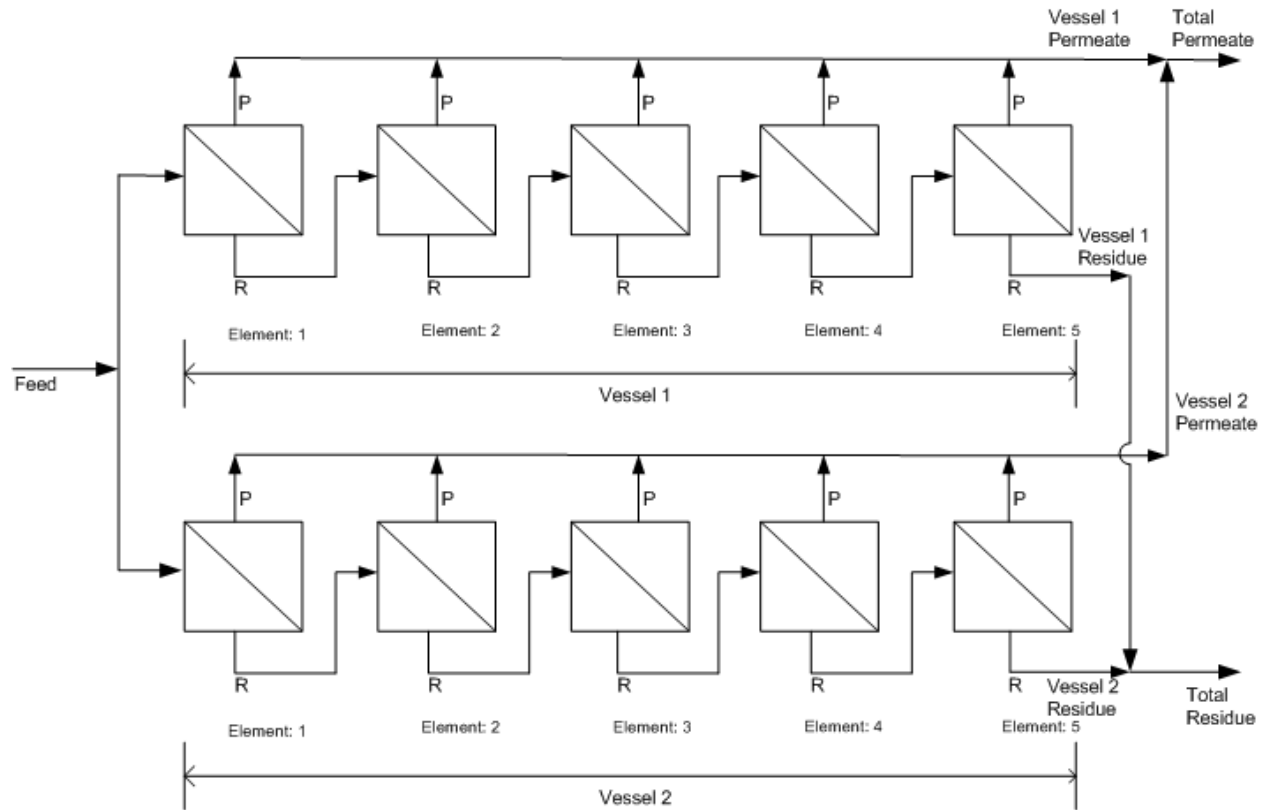

Fouling Factor

Fouling factor represents the resistance to flow through the membrane, hence sometimes termed as flow factor. The fouling factor is defined as the fraction of the water permeability of the membrane relative to a membrane with nominal flow specification. Hydranautics suggests a fouling factor of 1 in the projection is used to calculate the performance of new elements with exactly nominal flow rate. A fouling factor < 1 should be applied when making a design for long-term operation.

Concentration Polarization

When a component is enriched at the membrane surface, then mass balance dictates that a second component is depleted at the surface. Because the feed mixture components permeate at different rates, concentration gradients form in the fluids at the boundary layer. This phenomenon is called concentration polarization. Unless the solutions are extremely well stirred, concentration gradients form in the solutions on either side of the membrane. Concentration polarization is the measure of the intensity of concentration gradients occurring at the surface relative to the total absence of concentration polarization (value 1).

Pressure Drop Per Element

Feed side pressure may reduce during operation, resulting in a decrease of the hydraulic pressure difference across the membrane. Thus, the feed pressure of the 2nd element (e.g., residue pressure of 1st element) may decrease. Users can specify the pressure drop per element. In the absence of the user-specified value, the software will calculate the pressure drop.

Control Electroneutrality

Since the permeation rates of the species are different, there could be an imbalance of the associated ions. An electroneutrality balance must be achieved on both sides of the membrane. This option controls how the electroneutrality balance will be achieved any time you are out of balance in the solver. By default, it is Cation Control. Currently, we follow “Prorate Cations and Prorate Anions” selection as you’ve seen in OLI Studio. Electroneutrality balance by adjusting cations or anions should result in the same flux across the membrane.

Manufacturer Data Sheet for RO Membranes

Membrane manufacturers provide a technical sheet for each type of membrane. In addition to physical dimensions (such as membrane area, spacer arrangement, tube diameter, and so on), the technical sheet also reports results of a standard experimental measurement of the membrane, that is, permeate flux, recovery, and rejection percentage for NaCl (or other salts) aqueous solution at 25 °C. These are the data we will use to calibrate membrane properties.

The following are standard product sheet information from different manufacturers.

Example 1: GE

Model	Average permeate flow gpd (m3/day) ^{1,2}	Average NaCl rejection ^{1,2}	Minimum NaCl rejection ^{1,2}
INDUSTRIAL RO3 4040F35	1,900 (7.2)	99.0%	98.5%
INDUSTRIAL RO3 4040F50	1,450 (5.5)	99.0%	98.5%
INDUSTRIAL RO3 8040F35	7,800 (29.5)	99.0%	98.5%
INDUSTRIAL RO3 8040F50	6,500 (24.6)	99.0%	98.5%
INDUSTRIAL RO5 4040F35	1,950 (7.4)	99.5%	99.0%
INDUSTRIAL RO5 8040F35	9,100 (34.4)	99.5%	99.0%
INDUSTRIAL RO5 8040F50	7,400 (28.0)	99.5%	99.0%
INDUSTRIAL RO6 4040F35	3,250 (12.3)	99.0%	98.0%
INDUSTRIAL RO6 8040F35	15,400 (58.3)	99.0%	98.0%

¹ Average salt rejection after 24h operation. Individual flow rate may vary ±25%.
² Testing conditions: 2,000ppm NaCl solution at 425psi (2,930kPa) operating pressure for RO3 vs 225psi (1,550kPa) for RO5 and RO6, 77°F, pH 6.5 and 15% recovery.

Model	Spacer mil (mm)	Active area ft ² (m ²)	Outer wrap	Part number
INDUSTRIAL RO3 4040F35	35 (0.89)	77 (7.1)	Fiberglass	3050577
INDUSTRIAL RO3 4040F50	50 (1.27)	61 (5.7)	Fiberglass	3049999
INDUSTRIAL RO3 8040F35	35 (0.89)	333 (30.9)	Fiberglass	1207451
INDUSTRIAL RO3 8040F50	50 (1.27)	269 (25.0)	Fiberglass	1207450
INDUSTRIAL RO5 4040F35	35 (0.89)	77 (7.1)	Fiberglass	3050576
INDUSTRIAL RO5 8040F35	35 (0.89)	333 (30.9)	Fiberglass	3144696
INDUSTRIAL RO5 8040F50	50 (1.27)	269 (25.0)	Fiberglass	3097294
INDUSTRIAL RO6 4040F35	35 (0.89)	77 (7.1)	Fiberglass	3144699
INDUSTRIAL RO6 8040F35	35 (0.89)	333 (30.9)	Fiberglass	3144697

Example 2: Hydranautics

Product Specifications

Element	Active Area	Pressure	Flow	Rejection(%)	Conc(ppm)	Salt	Recovery(%)
LE-400	400 (37.2)	150 (10.3)	11,500 (43.5)	99.3	2000	NaCl	15
SW30XHR-440i	440 (40.9)	800 (55.2)	6,600 (25.0)	99.82	32000	NaCl	8
SW30XHR-400i	400 (37.2)	800 (55.2)	6,000 (22.7)	99.82	32000	NaCl	8
SW30HR-380	380 (35.3)	800 (55.2)	6,000 (23)	99.7	32000	NaCl	8
SW30HRLE-440i	440 (40.9)	800 (55.2)	8,200 (31.0)	99.80	32000	NaCl	8
SW30HRLE-400i	400 (37.2)	800 (55.2)	7,500 (28.4)	99.80	32000	NaCl	8
SW30HRLE-370/34i	370 (34.4)	800 (55.2)	6,700 (25.3)	99.8	32000	NaCl	8
SW30XLE-440i	440 (40.9)	800 (55.2)	9,900 (37.5)	99.80	32000	NaCl	8
SW30XLE-400i	400 (37.2)	800 (55.2)	9,000 (34.1)	99.80	32000	NaCl	8
SW30ULE-440i	440 (40.9)	800 (55.2)	12,000 (45.4)	99.70	32000	NaCl	8
SW30ULE-400i	400 (37.2)	800 (55.2)	11,000 (41.6)	99.7	32000	NaCl	8
NF90-400	400 (37.2)	70 (4.8)	10,000 (37.9)	97.0	2000	MgSO4	15
NF90-400/34i	400 (37.2)	70 (4.8)	10,000 (37.9)	97.0	2000	MgSO4	15

Active Area units: square feet (square meters)
 Pressure units: psi (bar)
 Flow units: gallons per day (cubic meters per day)

Close Window

Example 3: Koch

PRODUCT DESCRIPTION	Membrane Chemistry:	Proprietary TFC® polyamide						
	Membrane Type:	TFC® HR membrane						
	Construction:	Spiral wound with fiberglass outerwrap						
	Applications:	High rejection for brackish water treatment						
SPECIFICATIONS	Part Number	Model	Permeate Flow		Chloride Rejection	Active Membrane Area	Feed Spacer	
			gpd	(m ³ /d)	percent	ft ²	(m ²)	mil (mm)
	8882234	8040-HR-375	10,200	(38.6)	99.55	375	(34.8)	31 (0.8)
Test Conditions: 2,000 mg/l NaCl solution at 225 psi (1,550 kPa) applied pressure, 15% recovery, 77°F (25°C) and pH 7.5								

Appendix-2 Optimizer and Calculator Block Mathematical Functions

The mathematical functions used in defining subexpressions for the Calculator Functionality and Optimizer are derived from the Lua programming language. Below is a list of common Lua mathematical functions supported by OLI.

Table 2 Optimizer and Calculator Block mathematical functions to write subexpressions

Mathematical functions	Uses
<code>math.abs(x)</code>	Return the absolute, or non-negative value of x.
<code>math.exp(x)</code>	Returns the value e^x .
<code>x^y</code>	Returns x to the power of y.
<code>math.sqrt(x)</code>	Returns the square root of x, you can also use the expression $x^{0.5}$ to compute this value.
<code>math.log(x)</code>	Returns the natural logarithm of x.
<code>math.log(x,10)</code>	Returns the base-10 logarithm of x.
<code>math.pi</code>	Returns the value of PI.
<code>math.ceil(x)</code>	Returns the smallest integer larger than or equal to x.
<code>math.floor(x)</code>	Returns the largest integer smaller than or equal to x.
<code>math.fmod(x, y)</code>	Returns the remainder of the division of x by y that rounds the quotient towards zero.
<code>math.max(x, ...)</code>	Returns the maximum value among its arguments.
<code>math.min(x, ...)</code>	Returns the minimum value among its arguments.
<code>math.sin(x)</code>	Returns the sine of x (assumed to be in radians).
<code>math.cos(x)</code>	Returns the cosine of x (assumed to be in radians).
<code>math.tan(x)</code>	Returns the tangent of x (assumed to be in radians).
<code>math.asin(x)</code>	Returns the arcsine of x (in radians).
<code>math.acos(x)</code>	Returns the arccosine of x (in radians).
<code>math.atan(x)</code>	Returns the arctangent of x (in radians).
<code>math.deg(x)</code>	Returns the angle x (given in radians) in degrees.
<code>math.rad(x)</code>	Returns the angle x (given in degrees) in radians.

Lua defines/objective function NAMING rules:

- Names should not contain spaces (e.g., Calculated pH)
- Names should not start with numbers (e.g., 123ABC)
- Names consisting only of numbers are not allowed (e.g., 007)
- Avoid using special characters (e.g., XYZ(6), XYZ\$)
- Avoid using "+", "-", "*" in names (e.g., XYZ-6, Calculated-pH)
- Names with underscores are acceptable (e.g., Calculated_pH)
- Names can start with an underscore (e.g., _XYZ)